

ONE BOARDLOCK
(LEFT)

NOTE:

- MATERIAL:
HOUSING: PA9T, UL94 V-0, COLOR: (SEE TABLE).
CONTACTS: BRASS.
- FINISH:
CONTACTS: 3.05um [120u"] MIN. MATTE-TIN.
1.27um [50u"] MIN. NICKEL UNDERPLATED ALL OVER.
- WAVE SOLDER CAPABLE TO 265°C PER TEST SPEC.
109-202, CONDITION B.
- NO TE LOGO AND DATE CODE ON THE PRODUCT WITH 4 POS.
- THE KEY IDENTIFIED WAS SHOWN ON PAGE 5.

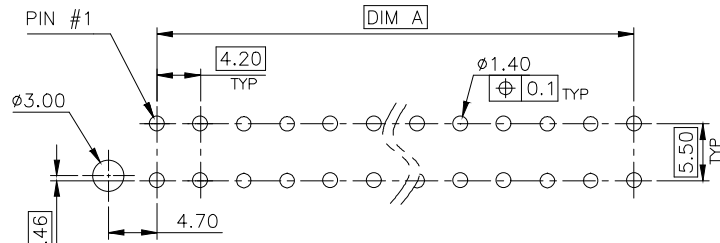

RECOMMENDED PCB LAYOUT
TOLERANCE: ±0.05 T=1.6mm

BLACK PA9T	1.52	8.4	13.7	15.75	6	6-5099-6
IVORY PA9T	5.40	46.2	51.5	53.55	24	1-5099-3
	1.13	4.2	9.5	11.55	4	1-5099-2
	4.30	37.8	43.1	45.15	20	1-5099-1
	3.90	33.6	38.9	40.95	18	1-5099-0
	3.11	25.2	30.5	32.55	14	5099-9
	2.71	21.0	26.3	28.35	12	5099-8
	2.31	16.8	22.1	24.15	10	5099-7
	1.52	8.4	13.7	15.75	6	5099-6
1.92	12.6	17.9	19.95	8	5099-5	
HSG COLOR & MATERIAL	WEIGHT	DIM A	DIM B	DIM C	POS.	PART NUMBER

				TOLERANCE		UMax conn 东莞市友贸实业有限公司 DONGGUAN UMAXCONN ENTERPRISE LIMITED		TITLE: ATX POWER CONNECTOR 4.2mm PITCH, VERTICAL, DIP TYPE				
				LINEAR	ANGLES			PART NO. SEE TABLE				
				X±0.40	X°±	APPD: Jason	MAT'L:	DWG NO. C-5099				
				.X±0.30	.X°±	CHKD: Schumi	FINISH:		UNITS	SCALE	SHEET	REV
REV	ECN NO.	NAME	DATE	.XX±0.20	.XX°±	DRWN: Terry	Q'TY:		MM	1 : 1	1 OF 6	0
				.XXX±0.10	.XXX°±	CUSTOMER						

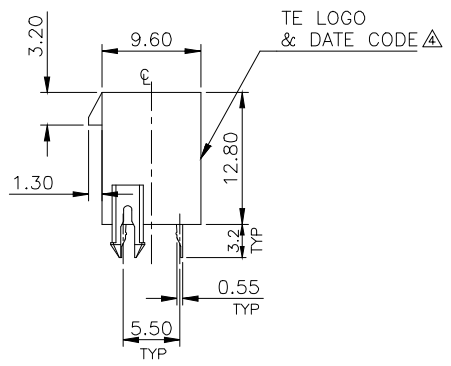
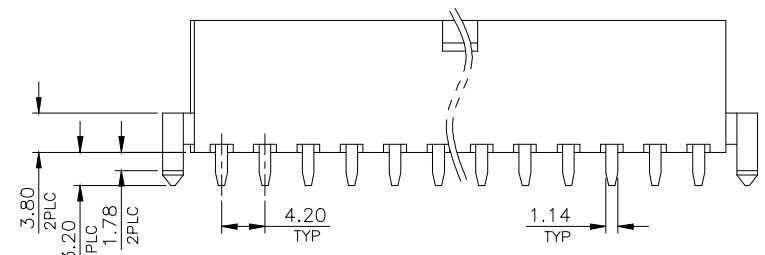
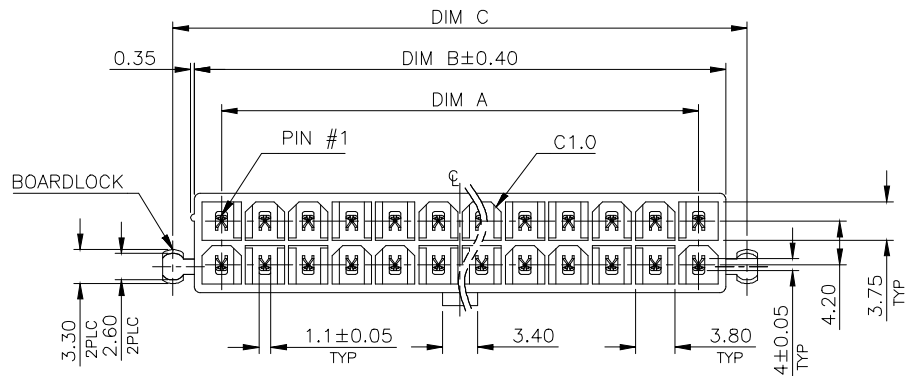

TWO BOARDLOCK

- NOTE:
- MATERIAL:
HOUSING: PA9T, UL94 V-0, COLOR: (SEE TABLE).
CONTACTS: BRASS.
 - FINISH:
CONTACTS: 3.05um [120u"] MIN. MATTE-TIN.
1.27um [50u"] MIN. NICKEL UNDERPLATED ALL OVER.
 - WAVE SOLDER CAPABLE TO 265°C PER TEST SPEC.
109-202, CONDITION B.
 - NO TE LOGO AND DATE CODE ON THE PRODUCT WITH 4 POS.
 - THE KEY IDENTIFIED WAS SHOWN ON PAGE 5.

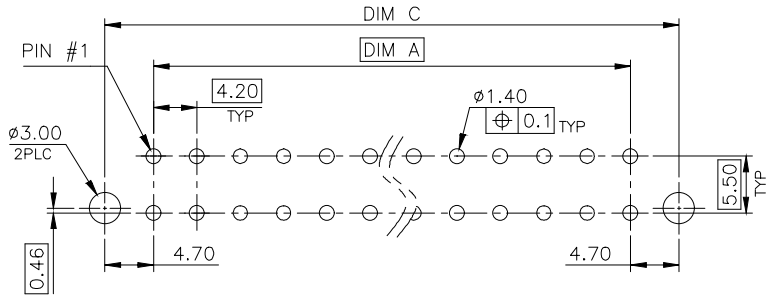

RECOMMENDED PCB LAYOUT
TOLERANCE: ±0.05 T=1.6mm

IVORY PA9T	3.54	29.4	34.7	38.8	16	2-5099-9
	5.43	46.2	51.5	55.6	24	2-5099-8
	4.33	37.8	43.1	47.2	20	2-5099-7
	3.93	33.6	38.9	43.0	18	2-5099-6
	3.14	25.2	30.5	34.6	14	2-5099-5
	2.74	21.0	26.3	30.4	12	2-5099-4
	2.34	16.8	22.1	26.2	10	2-5099-3
	1.95	12.6	17.9	22.0	8	2-5099-2
	1.55	8.4	13.7	17.8	6	2-5099-1
1.16	4.2	9.5	13.6	4	2-5099-0	
HSG COLOR & MATERIAL	WEIGHT	DIM A	DIM B	DIM C	POS.	PART NUMBER

				TOLERANCE		UMax conn 东莞市友贸实业有限公司 DONGGUAN UMAXCONN ENTERPRISE LIMITED		TITLE: ATX POWER CONNECTOR 4.2mm PITCH, VERTICAL, DIP TYPE				
				LINEAR	ANGLES			PART NO. SEE TABLE				
				X±0.40	X°±	APPD: Jason	MAT'L:	DWG NO. C-5099				
				.X±0.30	.X°±	CHKD: Schumi	FINISH:		UNITS	SCALE	SHEET	REV
REV	ECN NO.	NAME	DATE	.XX±0.20	.XX°±	DRWN: Terry	Q'TY:		MM	1 : 1	2 OF 6	0
				.XXX±0.10	.XXX°±					CUSTOMER		

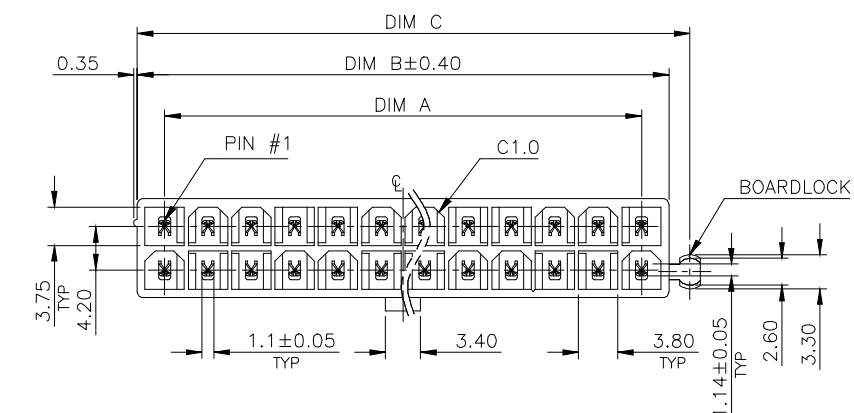

- NOTE:
- MATERIAL:
 - HOUSING: PA9T, UL94 V-0, COLOR: (SEE TABLE).
 - CONTACTS: BRASS.
 - FINISH:
 - CONTACTS: 3.05um [120u"] MIN. MATTE-TIN.
 - 1.27um [50u"] MIN. NICKEL UNDERPLATED ALL OVER.
 - WAVE SOLDER CAPABLE TO 265°C PER TEST SPEC. 109-202, CONDITION B.
 - NO TE LOGO AND DATE CODE ON THE PRODUCT WITH 4 POS.
 - THE KEY IDENTIFIED WAS SHOWN ON PAGE 5.

ONE BOARDLOCK (RIGHT)

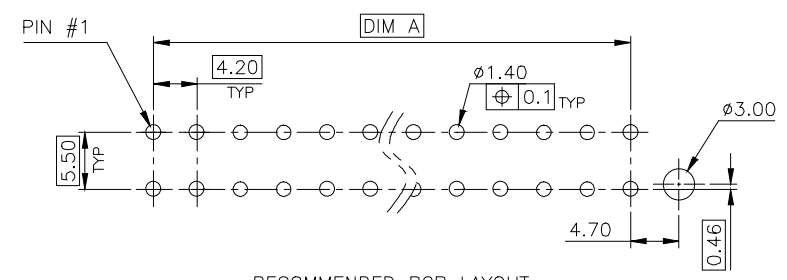
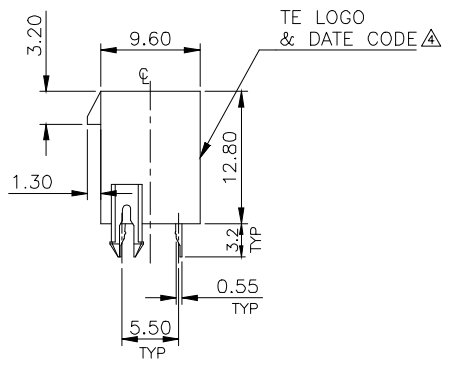
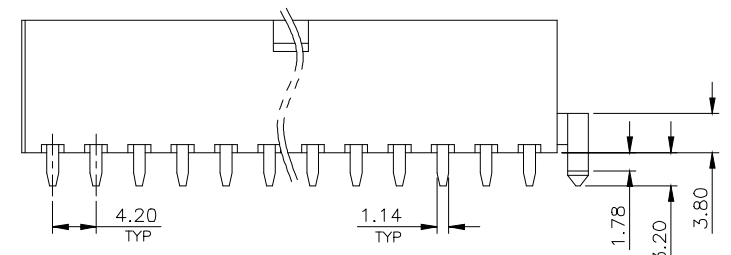

RECOMMENDED PCB LAYOUT
TOLERANCE: ±0.05 T=1.6mm

IVORY PA9T	5.40	46.2	51.5	53.55	24	3-5099-8
	4.30	37.8	43.1	45.15	20	3-5099-7
	3.90	33.6	38.9	40.95	18	3-5099-6
	3.11	25.2	30.5	32.55	14	3-5099-5
	2.71	21.0	26.3	28.35	12	3-5099-4
	2.31	16.8	22.1	24.15	10	3-5099-3
	1.92	12.6	17.9	19.95	8	3-5099-2
	1.52	8.4	13.7	15.75	6	3-5099-1
1.13	4.2	9.5	11.55	4	3-5099-0	
HSG COLOR & MATERIAL	WEIGHT	DIM A	DIM B	DIM C	POS.	PART NUMBER

				TOLERANCE		UMax conn 东莞市友贸实业有限公司 DONGGUAN UMAXCONN ENTERPRISE LIMITED		TITLE: ATX POWER CONNECTOR 4.2mm PITCH, VERTICAL, DIP TYPE				
				LINEAR	ANGLES			PART NO. SEE TABLE				
				X±0.40	X°±	APPD: Jason	MAT'L:	DWG NO. C-5099				
				.X±0.30	.X°±	CHKD: Schumi	FINISH:		UNITS	SCALE	SHEET	REV
REV	ECN NO.	NAME	DATE	.XX±0.20	.XX°±	DRWN: Terry	Q'TY:		MM	1 : 1	3 OF 6	0
				.XXX±0.10	.XXX°±							

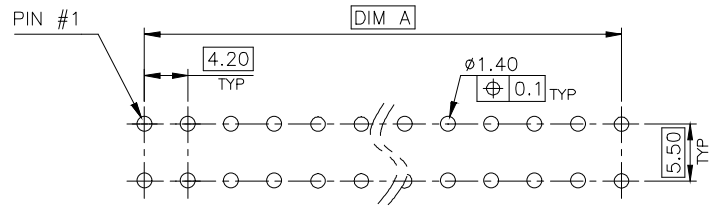
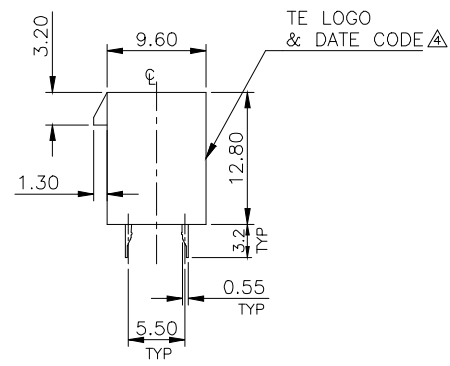
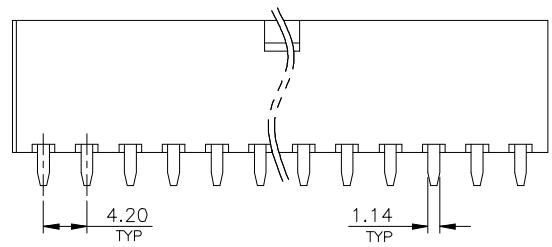
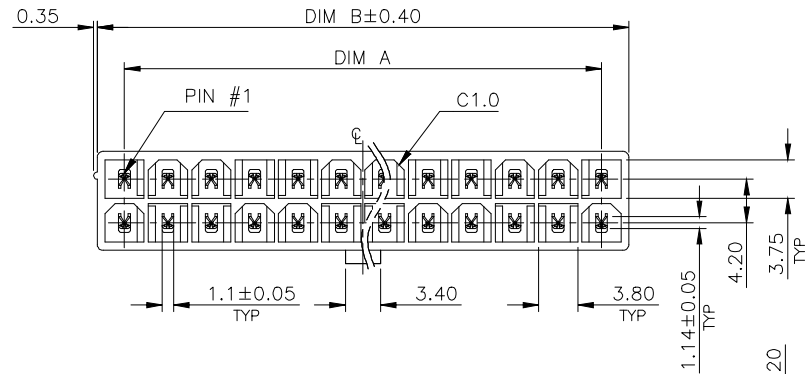

RECOMMENDED PCB LAYOUT
TOLERANCE: ±0.05 T=1.6mm

- NOTE:
- MATERIAL:
HOUSING: PA9T, UL94 V-0, COLOR: (SEE TABLE).
CONTACTS: BRASS.
 - FINISH:
CONTACTS: 3.05um [120u"] MIN. MATTE-TIN.
1.27um [50u"] MIN. NICKEL UNDERPLATED ALL OVER.
 - WAVE SOLDER CAPABLE TO 265°C PER TEST SPEC.
109-202, CONDITION B.
 - NO TE LOGO AND DATE CODE ON THE PRODUCT WITH 4 POS.
 - THE KEY IDENTIFIED WAS SHOWN ON PAGE 5.

NO BOARDLOCK

IVORY PA9T	5.37	46.2	51.5	24	4-5099-8
	4.27	37.8	43.1	20	4-5099-7
	3.87	33.6	38.9	18	4-5099-6
	3.08	25.2	30.5	14	4-5099-5
	2.68	21.0	26.3	12	4-5099-4
	2.28	16.8	22.1	10	4-5099-3
	1.89	12.6	17.9	8	4-5099-2
	1.49	8.4	13.7	6	4-5099-1
	1.10	4.2	9.5	4	4-5099-0
HSG COLOR & MATERIAL	WEIGHT	DIM A	DIM B	POS.	PART NUMBER

				TOLERANCE		UMax conn 东莞市友贸实业有限公司 DONGGUAN UMAXCONN ENTERPRISE LIMITED		TITLE: ATX POWER CONNECTOR 4.2mm PITCH, VERTICAL, DIP TYPE				
				LINEAR	ANGLES			PART NO. SEE TABLE				
				X±0.40	X°±	APPD: Jason	MAT'L:	DWG NO. C-5099				
				.X±0.30	.X°±	CHKD: Schumi	FINISH:		UNITS	SCALE	SHEET	REV
REV	ECN NO.	NAME	DATE	.XX±0.20	.XX°±	DRWN: Terry	Q'TY:		MM	1 : 1	4 OF 6	0
				.XXX±0.10	.XXX°±							

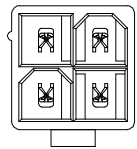

4 POS

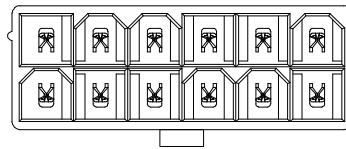

12 POS

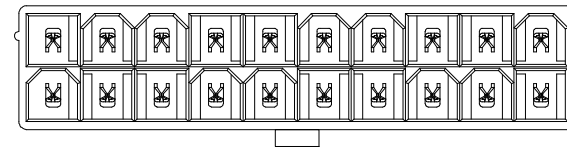

20 POS

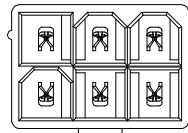

6 POS

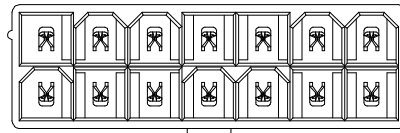

14 POS

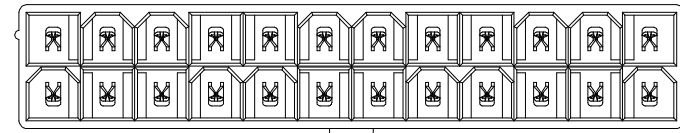

24 POS

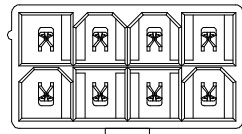

8 POS

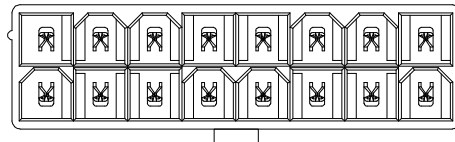

16 POS

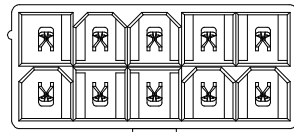

10 POS

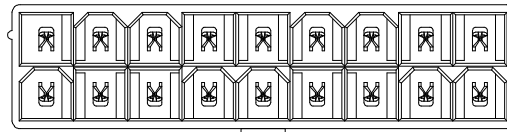

18 POS

KEY POSITION IDENTIFIED
(TOP VIEW)

REV	ECN NO.	NAME	DATE	TOLERANCE	
				LINEAR	ANGLES
				X,±0.40	X°,±
				.X,±0.30	.X°,±
				.XX,±0.20	.XX°,±
				.XXX,±0.10	.XXX°,±

UMax conn 东莞市友贸实业有限公司
DONGGUAN UMAXCONN ENTERPRISE LIMITED

APPD: Jason MAT'L:
CHKD: Schumi FINISH:
DRWN: Terry Q'TY:

TITLE:		ATX POWER CONNECTOR 4.2mm PITCH, VERTICAL, DIP TYPE			
PART NO.		SEE TABLE			
DWG NO.		C-5099			
	UNITS	SCALE	SHEET	REV	
	MM	1 : 1	5 OF 6	0	

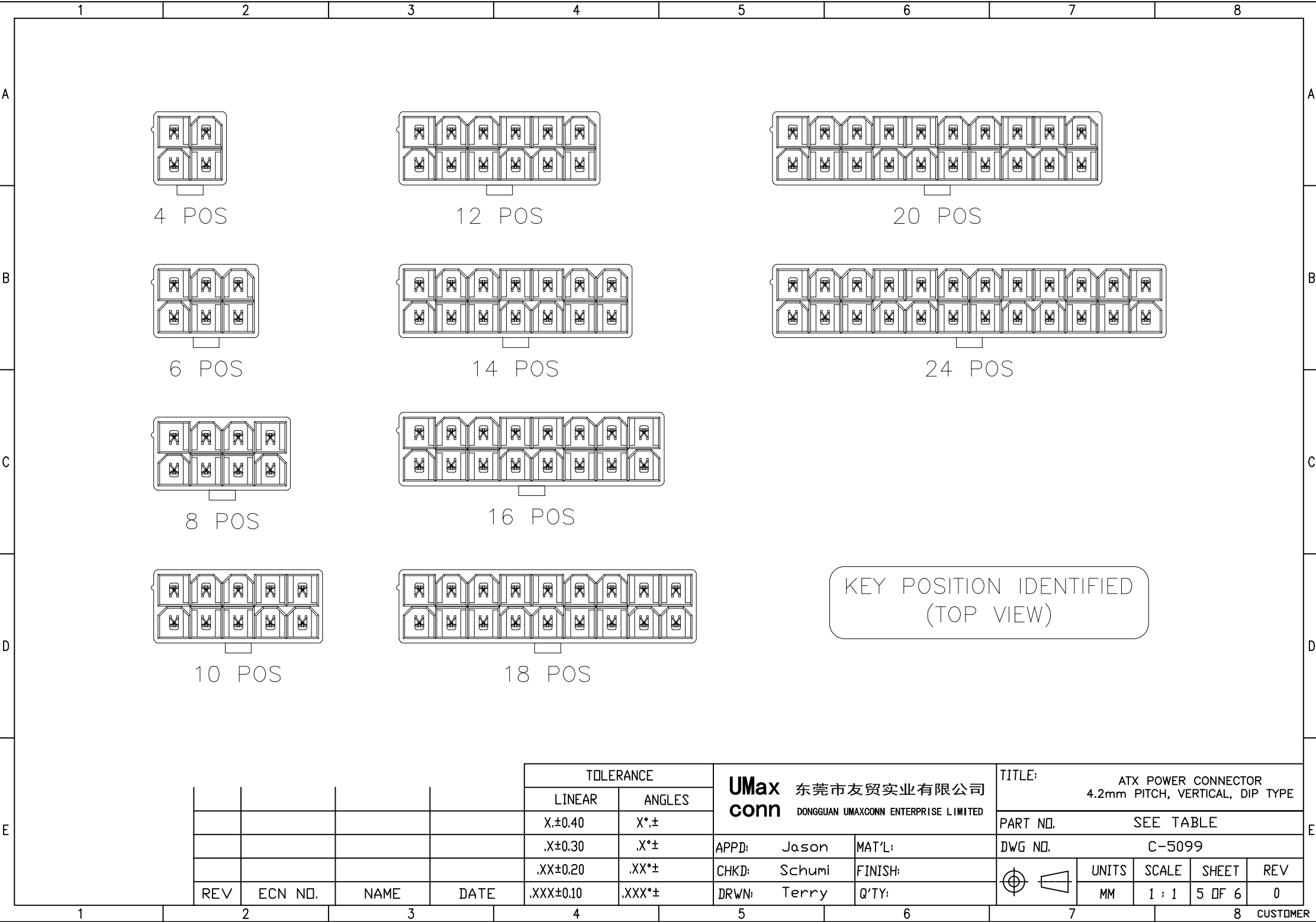

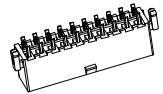
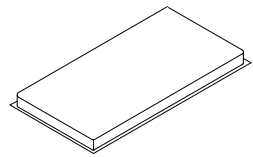

QUANTITY SEE TABLE

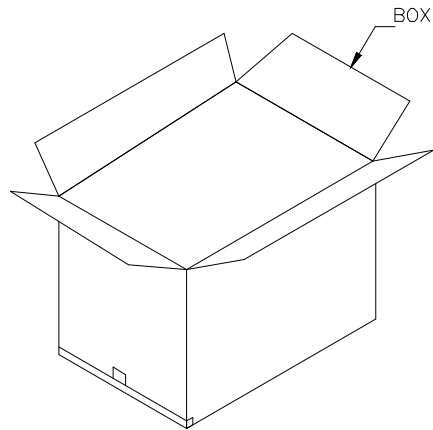
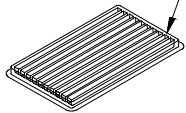

BOX

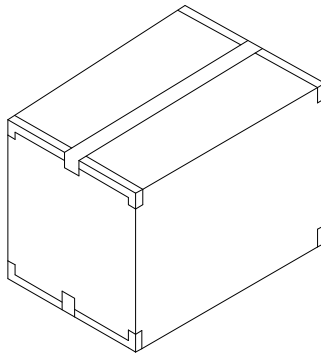
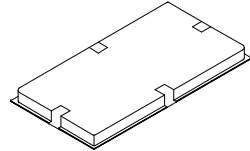

10 TRAY

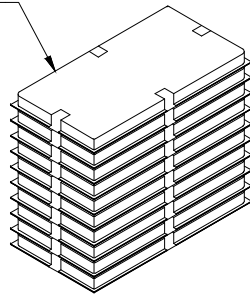

NOTES:

- 1. TRAY : PVC, SIZE: 330mm(L)X 265mm(W)X 22mm(H).
- 2. BOX : CORRUGATED, SIZE: 350mm(L)X 279mm(W)X 195mm(H).
- 3. QUANTITY: SEE TABLE.

LINE NO.	TRAY NO.	TRAY L	TRAY W	TRAY H	TRAY QTY	BOX QTY	NO. OF BOARDLOCK
2	5.94	4.34	80	10	800	24	
2	5.93	4.33	100	10	1000	20	
2	5.53	3.93	100	10	1000	18	
2	5.85	4.25	120	10	1200	16	
2	6.00	4.40	140	10	1400	14	
2	5.98	4.38	160	10	1600	12	
2	5.81	4.21	180	10	1800	10	
2	5.89	4.29	220	10	2200	8	
2	5.94	4.34	280	10	2800	6	
2	5.78	4.18	360	10	3600	4	
2	5.92	4.32	80	10	800	24	
1	5.90	4.30	100	10	1000	20	
1	6.28	4.68	120	10	1200	18	
1	5.95	4.35	140	10	1400	14	
1	5.94	4.34	160	10	1600	12	
1	6.22	4.62	200	10	2000	10	
1	6.21	4.61	240	10	2400	8	
1	6.16	4.56	300	10	3000	6	
1	6.35	4.75	420	10	4200	4	
0	5.90	4.30	80	10	800	24	
0	5.87	4.27	100	10	1000	20	
0	6.24	4.64	120	10	1200	18	
0	5.91	4.31	140	10	1400	14	
0	6.42	4.82	180	10	1800	12	
0	6.16	4.56	200	10	2000	10	
0	6.51	4.91	260	10	2600	8	
0	6.67	5.07	340	10	3400	6	
0	6.88	5.28	480	10	4800	4	
GROSS WEIGHT	NET WEIGHT	PCS /TRAY	TRAYS /BOX	PCS /BOX	POS.	NO. OF BOARDLOCK	

REV	ECN NO.	NAME	DATE	TOLERANCE	
				LINEAR	ANGLES
				X±0.40	X°±
				.X±0.30	.X°±
				.XX±0.20	.XX°±
				.XXX±0.10	.XXX°±

UMax conn 东莞市友贸实业有限公司
DONGGUAN UMAXCONN ENTERPRISE LIMITED

APPD: Jason MAT'L:
CHKD: Schumi FINISH:
DRWN: Terry Q'TY:

TITLE: ATX POWER CONNECTOR
4.2mm PITCH, VERTICAL, DIP TYPE

PART NO. SEE TABLE

DWG NO. C-5099

UNITS	SCALE	SHEET	REV
MM	1 : 1	6 OF 6	0