

1-Line Ultra Small Bi-directional TVS Diode

Description

The PESDU0521P0N is a bi-directional TVS diode, utilizing leading monolithic silicon technology to provide fast-response time and low ESD clamping voltage, making this device an ideal solution for protecting voltage sensitive data and power line. The PESDU0521P0N complies with the IEC 61000-4-2 (ESD) standard with $\pm 15\text{kV}$ air and $\pm 8\text{kV}$ contact discharge. It is assembled into an ultra-small 0.6x0.3x0.3mm lead free DFN package. The ultra-small size and high ESD surge protection make PESDU0521P0N an ideal choice to replace 0201 size multilayer varistors (MLVs) and protect cell phone, digital cameras, audio players and many other portable applications.

Features

- Ultra small package: 0.6x0.3x0.3mm
- Low capacitance: 12pF (Typical)
- Protects one data or power line
- Ultra low leakage: nA level
- Low operating voltage: 5V
- Low clamping voltage
- 2-pin leadless package
- Complies with following standards:
 - IEC 61000-4-2(ESD) immunity test
Air discharge: $\pm 30\text{kV}$
Contact discharge: $\pm 30\text{kV}$
 - IEC61000-4-4 (EFT) 40A (5/50ns)
 - IEC61000-4-5 (Lightning) 4A (8/20 μs)
- RoHS Compliant

Dimensions and Pin Configuration

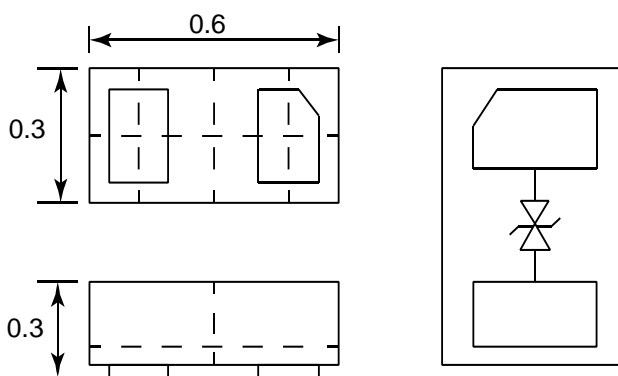

Package Dimensions

Circuit and Pin Schematic

Mechanical Characteristics

- Package: DFN0603-2 (0.6x0.3x0.3mm)
- Lead Finish: NiPdAu
- Case Material: "Green" Molding Compound.
- UL Flammability Classification Rating 94V-0
- Moisture Sensitivity: Level 3 per J-STD-020
- Terminal Connections: See Diagram Below
- Marking Information: See Below

Applications

- Cellular Handsets and Accessories
- Personal Digital Assistants
- Notebooks and Handhelds
- Portable Instrumentation
- Digital Cameras
- Peripherals
- Audio Players
- Keypads, Side Keys, USB 2.0, LCD Displays

Marking Information

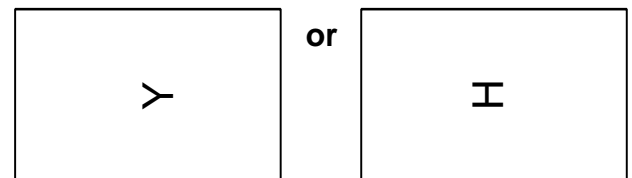

Y or H = Device Marking Code

Ordering Information

Part Number	Packaging	Reel Size
PESDU0521P0N	10000/Tape & Reel	7 inch

Absolute Maximum Ratings (T_A=25°C unless otherwise specified)

Parameter	Symbol	Value	Unit
Peak Pulse Power (8/20µs)	P _{PK}	40	W
Peak Pulse Current (8/20µs)	I _{PP}	4	A
ESD per IEC 61000-4-2 (Air) ESD per IEC 61000-4-2 (Contact)	V _{ESD}	± 30 ± 30	kV
Operating Temperature Range	T _J	-55 to +125	°C
Storage Temperature Range	T _{STG}	-55 to +150	°C

Electrical Characteristics (T_A=25°C unless otherwise specified)

Parameter	Symbol	Min	Typ	Max	Unit	Test Condition
Reverse Working Voltage	V _{RWM}			5	V	
Breakdown Voltage	V _{BR}	5.5	6.0	8.0	V	I _T = 1mA
Reverse Leakage Current	I _R		0.1	1.0	µA	V _{RWM} = 5V
Clamping Voltage	V _C		8		V	I _{PP} = 1A, tp = 8/20µs Between I/O_1 and I/O_2
Clamping Voltage	V _C		10		V	I _{PP} = 4A, tp = 8/20µs Between I/O_1 and I/O_2
Junction Capacitance	C _J	10	12	15	pF	V _R = 0V, f = 1MHz

Typical Performance Characteristics (T_A=25°C unless otherwise Specified)

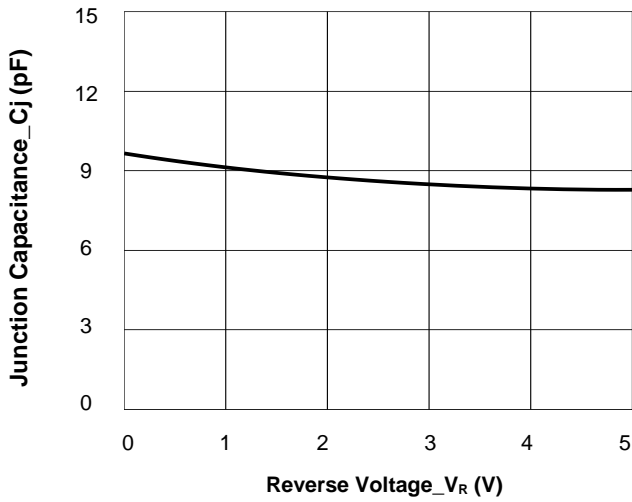

Junction Capacitance vs. Reverse Voltage

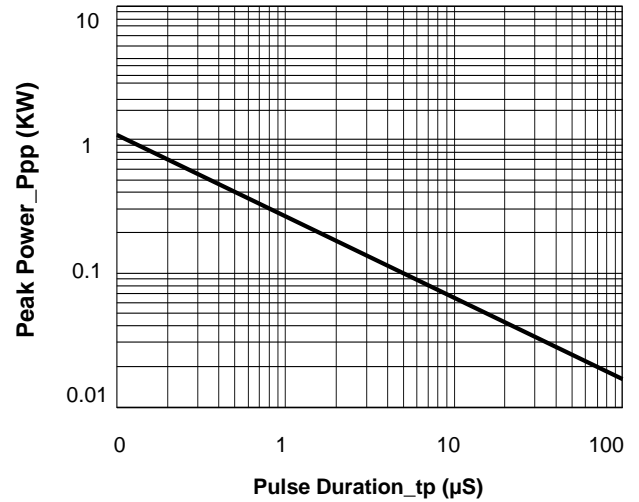

Peak Pulse Power vs. Pulse Time

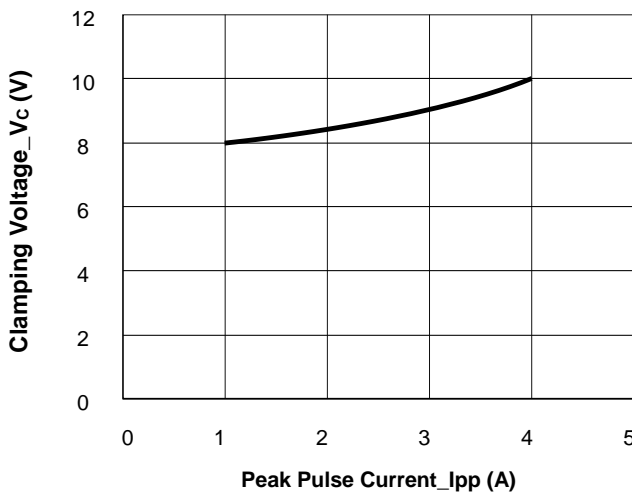

Clamping Voltage vs. Peak Pulse Current

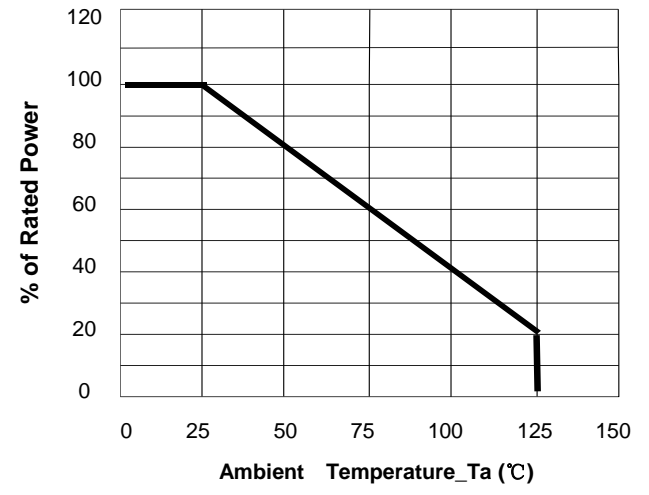

Power Derating Curve

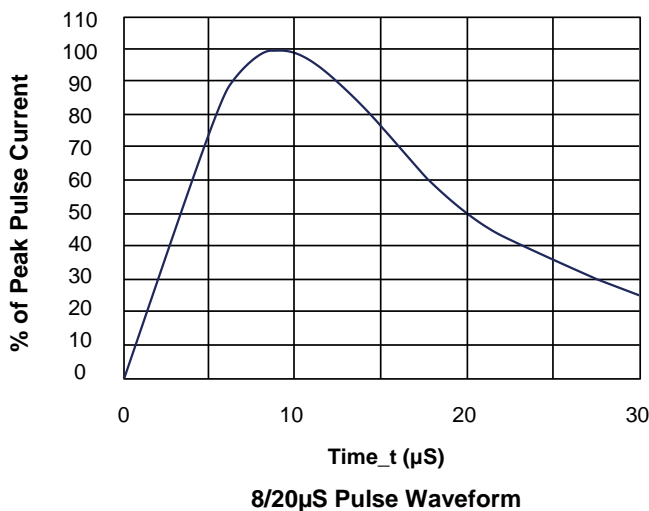

8/20μS Pulse Waveform

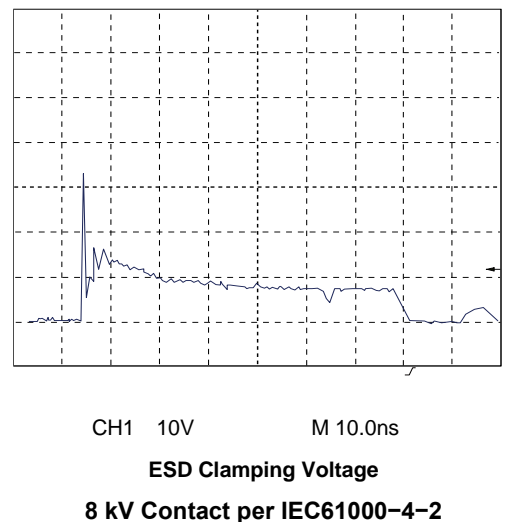

CH1 10V M 10.0ns

**ESD Clamping Voltage
8 kV Contact per IEC61000-4-2**

DFN0603-2 Package Outline Drawing

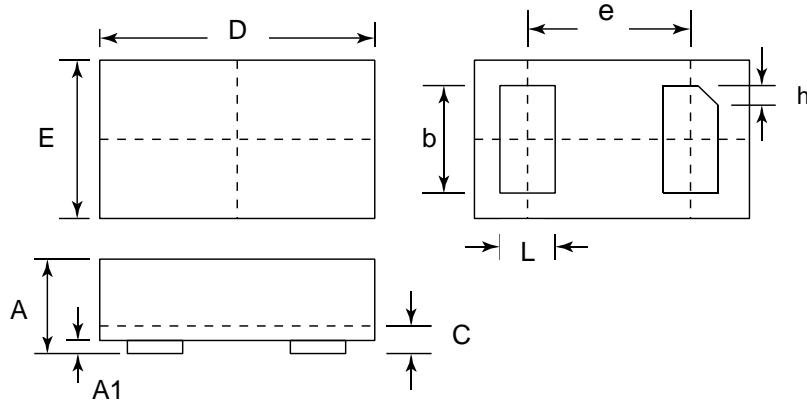

SYM	DIMENSIONS		
	MILLIMETERS		
	MIN	NOM	MAX
A	0.230		0.330
A1		0.020	0.050
b	0.215	0.245	0.275
c	0.120	0.150	0.180
D	0.550	0.600	0.650
e	0.355 BSC		
E	0.250	0.300	0.350
L	0.160	0.190	0.220
h	0.079 BSC		

Suggested Land Pattern

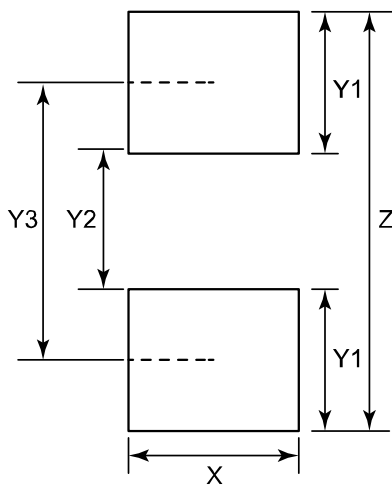

SYM	DIMENSIONS	
	MILLIMETERS	INCHES
X	0.30	0.30
Y1	0.25	0.010
Y2	0.15	0.006
Y3	0.40	0.016
Z	0.65	0.026