



ELCO EUROPE (A DIVISION OF AVX LTD.) CONFIDENTIAL PROPRIETARY
 THE DRAWING ON THIS PRINT AND INFORMATION THEREWITH ARE
 PROPRIETARY TO ELCO EUROPE (A DIVISION OF AVX LTD.) AND
 SHALL NOT BE USED OR DISCUSSED IN WHOLE OR IN PART
 WITHOUT ELCO EUROPE'S WRITTEN CONSENT.

XX-9159-XXX-101-X16

PREFIX _____

CODE	TYPE
10	PLUG
20	SOCKET

PRELIMINARY
 FOR INFORMATION ONLY

SERIES _____

NO. OF WAYS _____

CODE	NO. OF WAYS	PLUG DETAILS	SOCKET DETAILS
002	2	SHEET 2	SHEET 7
003	3	SHEET 3	SHEET 8
004	4	SHEET 4	SHEET 9
005	5	SHEET 5	SHEET 10
006	6	SHEET 6	SHEET 11

2 PART PCB STRIP CONNECTOR _____

CODE	DESCRIPTION
1	2 PART PCB STRIP CONNECTOR

CONNECTOR PITCH _____

CODE	PITCH
01	3mm

INSULATOR COLOUR _____

CODE	COLOUR	AVAILABILITY
0	BLACK	OPTIONAL
1	WHITE	STANDARD

PLATING OPTION _____

CODE	CONTACT	BRACKET
16	GOLD IN CONTACT AREA TIN ON SOLDER TAIL	TIN ALL OVER

SHEET 1 OF 11

FORM-106-01-056-6 ISS 7

Release No.
 History
 102559

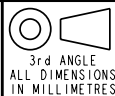

ELCO

© COPYRIGHT ELCO EUROPE
 NOT TO BE DISCLOSED OR COPIED
 WITHOUT WRITTEN PERMISSION

Drawn
 N.C.H.

Size
 CV

Description
 9159 TWO PART - ORDERING CODE

Part Number
 00-9159-01_100S

DATE
 06-Sept-04

Issue
 C

A

I

B

PLUG 2 WAY 2 PART PCB STRIP CONNECTOR

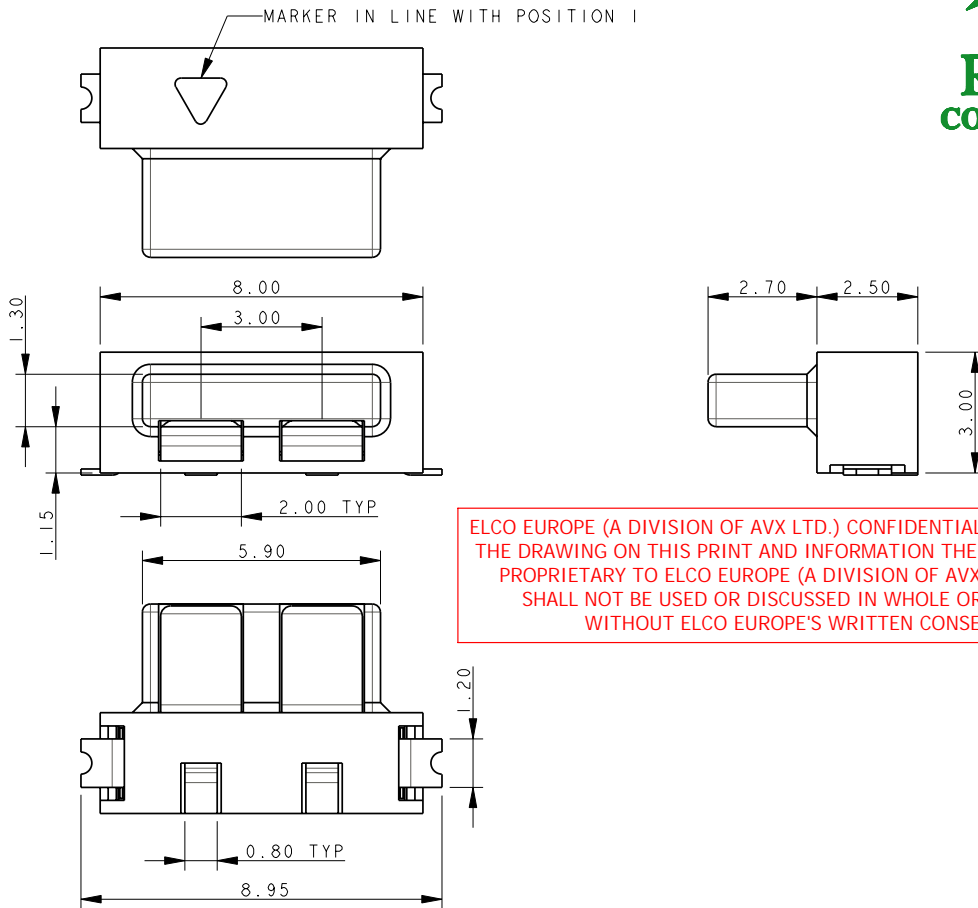

ELCO EUROPE (A DIVISION OF AVX LTD.) CONFIDENTIAL PROPRIETARY THE DRAWING ON THIS PRINT AND INFORMATION THEREWITH ARE PROPRIETARY TO ELCO EUROPE (A DIVISION OF AVX LTD.) AND SHALL NOT BE USED OR DISCUSSED IN WHOLE OR IN PART WITHOUT ELCO EUROPE'S WRITTEN CONSENT.

NOTES:

1. FOR MORE INFORMATION REFER TO PRODUCT SPEC 201-01-119.
2. DIMENSIONS ARE REFERENCE DIMENSIONS UNLESS TOLERANCED.
3. INSULATOR MATERIAL :- NYLON 46, COLOUR REFER TO SHEET 1.
4. CONTACT MATERIAL :- COPPER ALLOY, SELECTIVE GOLD OVER NICKEL TIN PLATED ON TAILS.
5. BRACKETS :- COPPER ALLOY, TIN PLATED.
6. OUTLINE OF CONNECTOR.
7. PACKING TAPE AND REEL, QUANTITY 1400 PER REEL.

2 WAY PCB BOARD LAYOUT

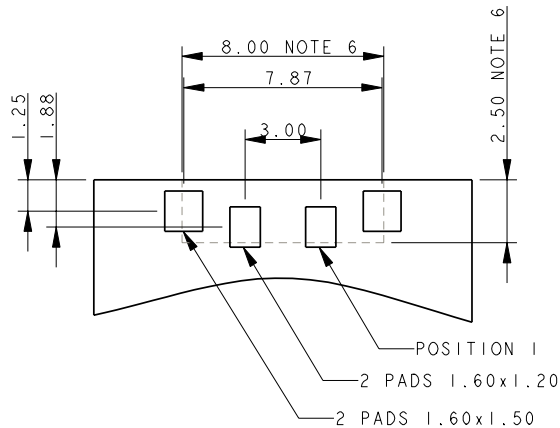

PACKING DETAILS TBC

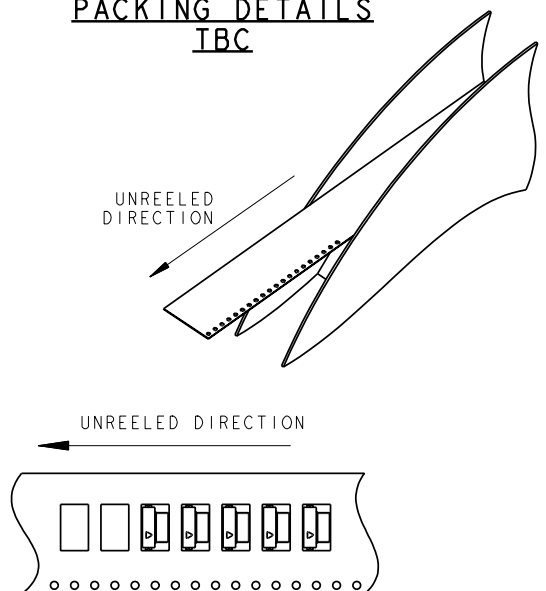

SHEET 2 TO 11

FORM-106-01-056-6 ISS 7

Release No.
History
102559

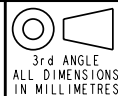

ELCO

© COPYRIGHT ELCO EUROPE
NOT TO BE DISCLOSED OR COPIED
WITHOUT WRITTEN PERMISSION

Drawn
N.C.H.

Size
CV

Description	DATE
9159 TWO PART - ORDERING CODE	06-Sept-04
Part Number	Issue
00-9159-01_100S	C

A

B

PLUG 3 WAY 2 PART PCB STRIP CONNECTOR

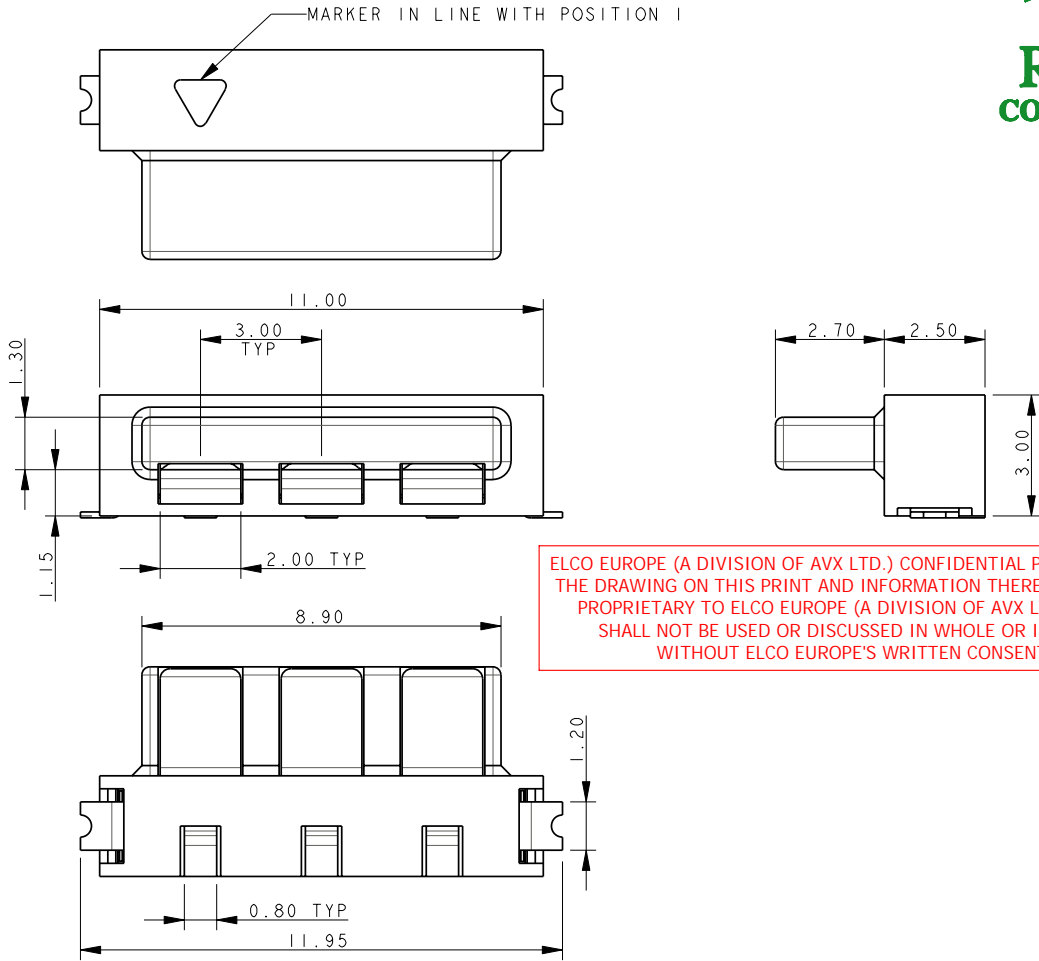

ELCO EUROPE (A DIVISION OF AVX LTD.) CONFIDENTIAL PROPRIETARY THE DRAWING ON THIS PRINT AND INFORMATION THEREWITH ARE PROPRIETARY TO ELCO EUROPE (A DIVISION OF AVX LTD.) AND SHALL NOT BE USED OR DISCUSSED IN WHOLE OR IN PART WITHOUT ELCO EUROPE'S WRITTEN CONSENT.

- NOTES:
1. FOR MORE INFORMATION REFER TO PRODUCT SPEC 201-01-119.
 2. DIMENSIONS ARE REFERENCE DIMENSIONS UNLESS TOLERANCED.
 3. INSULATOR MATERIAL :- NYLON 46, COLOUR REFER TO SHEET 1.
 4. CONTACT MATERIAL :- COPPER ALLOY, SELECTIVE GOLD OVER NICKEL TIN PLATED ON TAILS.
 5. BRACKETS :- COPPER ALLOY, TIN PLATED.
 6. OUTLINE OF CONNECTOR.
 7. PACKING TAPE AND REEL, QUANTITY 1400 PER REEL.

3 WAY BOARD LAYOUT

PACKING DETAILS TBC

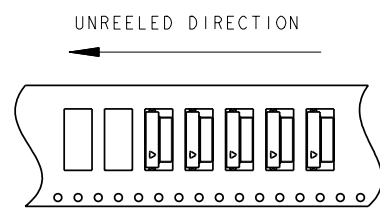
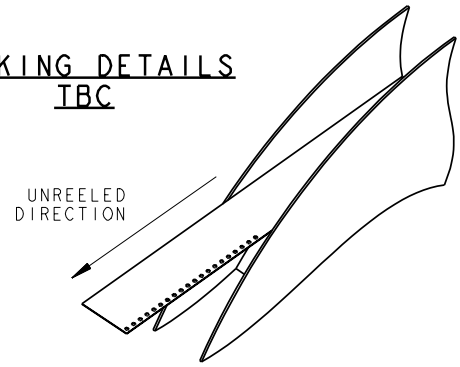
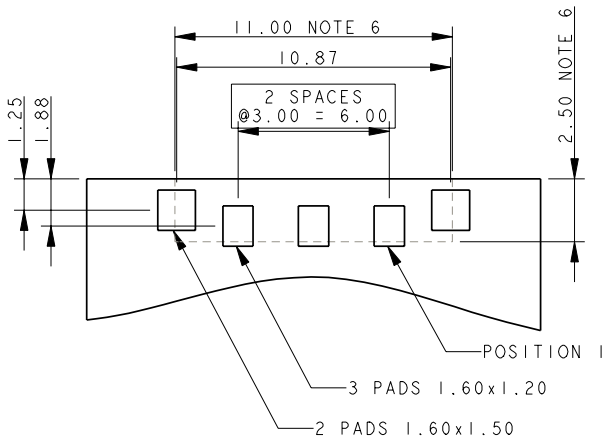

FORM-106-01-056-6 ISS 7

Release No.
History
102559



ELCO
© COPYRIGHT ELCO EUROPE
NOT TO BE DISCLOSED OR COPIED
WITHOUT WRITTEN PERMISSION

Drawn
N.C.H.
Size
CV

Description
9159 TWO PART - ORDERING CODE
Part Number
00-9159-01_100S

DATE
06-Sept-04
Issue
C

PLUG 4 WAY 2 PART PCB STRIP CONNECTOR

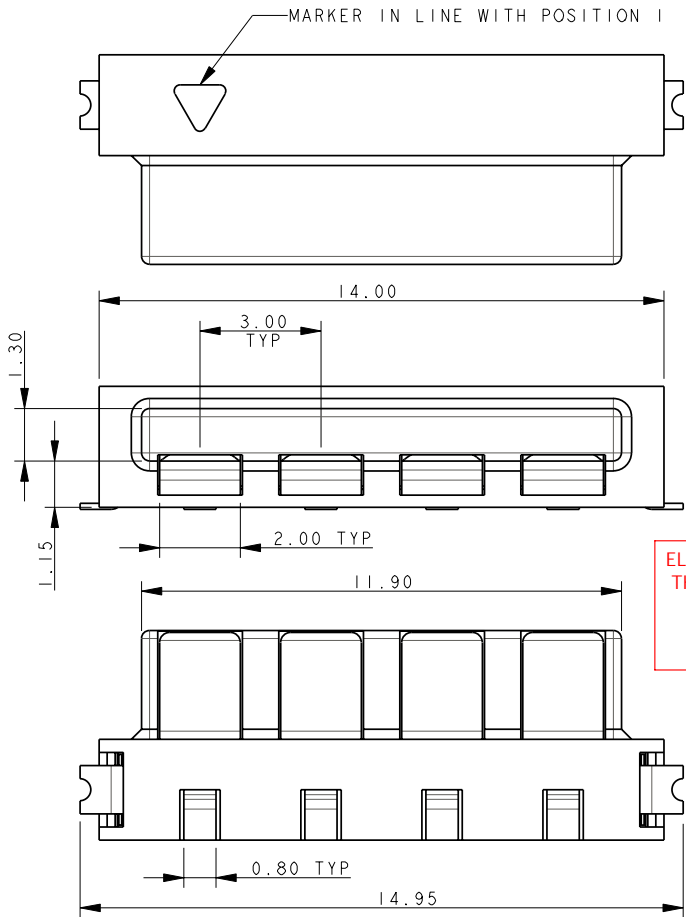

ELCO EUROPE (A DIVISION OF AVX LTD.) CONFIDENTIAL PROPRIETARY THE DRAWING ON THIS PRINT AND INFORMATION THEREWITH ARE PROPRIETARY TO ELCO EUROPE (A DIVISION OF AVX LTD.) AND SHALL NOT BE USED OR DISCUSSED IN WHOLE OR IN PART WITHOUT ELCO EUROPE'S WRITTEN CONSENT.

NOTES:

1. FOR MORE INFORMATION REFER TO PRODUCT SPEC 201-01-119.
2. DIMENSIONS ARE REFERENCE DIMENSIONS UNLESS TOLERANCED.
3. INSULATOR MATERIAL :- NYLON 46, COLOUR REFER TO SHEET 1.
4. CONTACT MATERIAL :- COPPER ALLOY, SELECTIVE GOLD OVER NICKEL TIN PLATED ON TAILS.
5. BRACKETS :- COPPER ALLOY, TIN PLATED.
6. OUTLINE OF CONNECTOR.
7. PACKING TAPE AND REEL, QUANTITY 1400 PER REEL.

PACKING DETAILS
TBC

4 WAY PCB BOARD LAYOUT

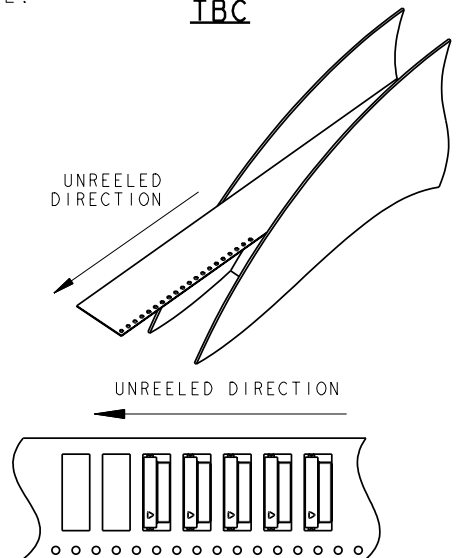
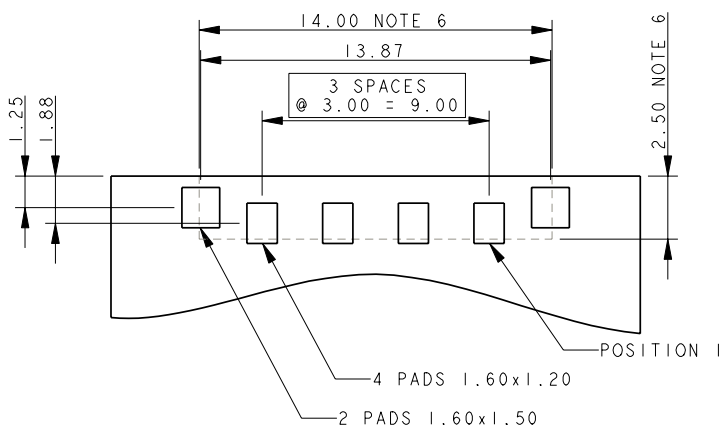

FORM-106-01-056-6 ISS 7

Release No.
History
102559

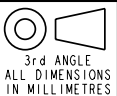

ELCO

© COPYRIGHT ELCO EUROPE
NOT TO BE DISCLOSED OR COPIED
WITHOUT WRITTEN PERMISSION

Drawn
N.C.H.

Size
CV

Description
9159 TWO PART - ORDERING CODE

Part Number
00-9159-01_100S

DATE
09-Sep-08

Issue
C

PLUG 5 WAY 2 PART PCB STRIP CONNECTOR



ELCO EUROPE (A DIVISION OF AVX LTD.) CONFIDENTIAL PROPRIETARY THE DRAWING ON THIS PRINT AND INFORMATION THEREWITH ARE PROPRIETARY TO ELCO EUROPE (A DIVISION OF AVX LTD.) AND SHALL NOT BE USED OR DISCUSSED IN WHOLE OR IN PART WITHOUT ELCO EUROPE'S WRITTEN CONSENT.

NOTES:

1. FOR MORE INFORMATION REFER TO PRODUCT SPEC 201-01-119.
2. DIMENSIONS ARE REFERENCE DIMENSIONS UNLESS TOLERANCED.
3. INSULATOR MATERIAL :- NYLON 46, COLOUR REFER TO SHEET 1.
4. CONTACT MATERIAL :- COPPER ALLOY, SELECTIVE GOLD OVER NICKEL TIN PLATED ON TAILS.
5. BRACKETS :- COPPER ALLOY, TIN PLATED.
6. OUTLINE OF CONNECTOR.
7. PACKING TAPE AND REEL, QUANTITY 1400 PER REEL.

5 WAY PCB BOARD LAYOUT



PACKING DETAILS TBC

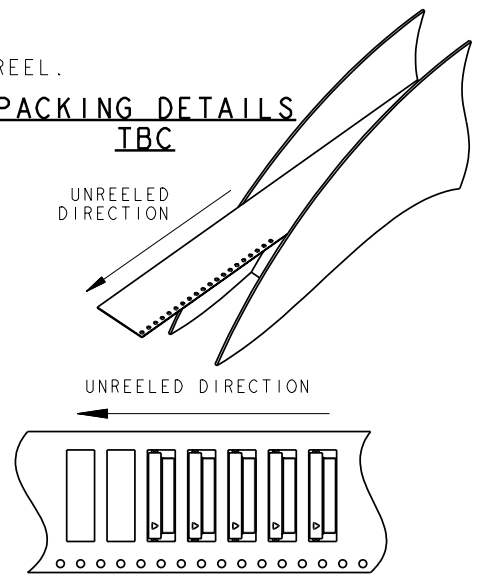

FORM-106-01-056-6 ISS 7

Release No.
History
101559

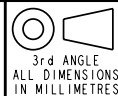

ELCO
© COPYRIGHT ELCO EUROPE
NOT TO BE DISCLOSED OR COPIED
WITHOUT WRITTEN PERMISSION

Drawn
N.C.H.

Size
CV

Description
9159 TWO PART - ORDERING CODE

Part Number
00-9159-01_100S

DATE
06-Sept-04

Issue
C

PLUG 6 WAY 2 PART PCB STRIP CONNECTOR

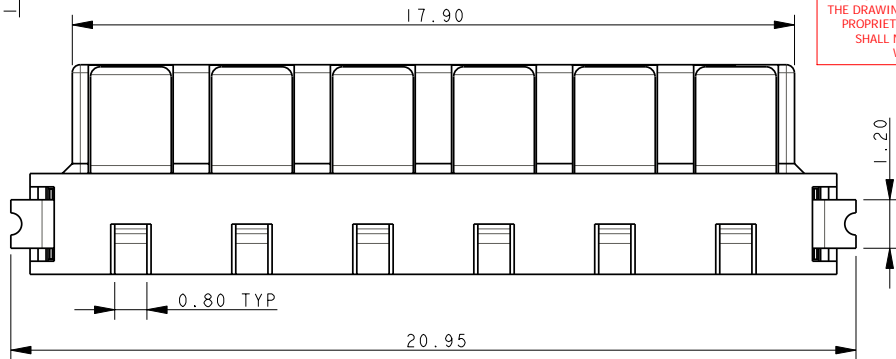
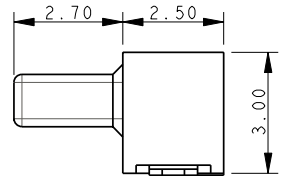
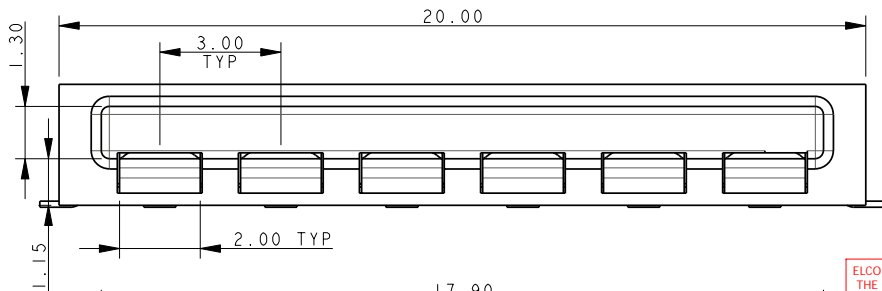

ELCO EUROPE (A DIVISION OF AVX LTD.) CONFIDENTIAL PROPRIETARY THE DRAWING ON THIS PRINT AND INFORMATION THEREWITH ARE PROPRIETARY TO ELCO EUROPE (A DIVISION OF AVX LTD.) AND SHALL NOT BE USED OR DISCUSSED IN WHOLE OR IN PART WITHOUT ELCO EUROPE'S WRITTEN CONSENT.

NOTES:

1. FOR MORE INFORMATION REFER TO PRODUCT SPEC 201-01-119.
2. DIMENSIONS ARE REFERENCE DIMENSIONS UNLESS TOLERANCED.
3. INSULATOR MATERIAL :- NYLON 46, COLOUR REFER TO SHEET 1.
4. CONTACT MATERIAL :- COPPER ALLOY, SELECTIVE GOLD OVER NICKEL TIN PLATED ON TAILS.
5. BRACKETS :- COPPER ALLOY, TIN PLATED.
6. OUTLINE OF CONNECTOR.
7. PACKING TAPE AND REEL, QUANTITY 1400 PER REEL.

PACKING DETAILS TBC

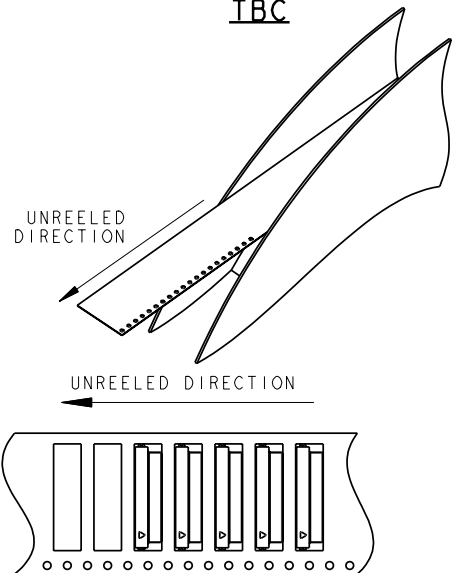

6 WAY PCB BOARD LAYOUT

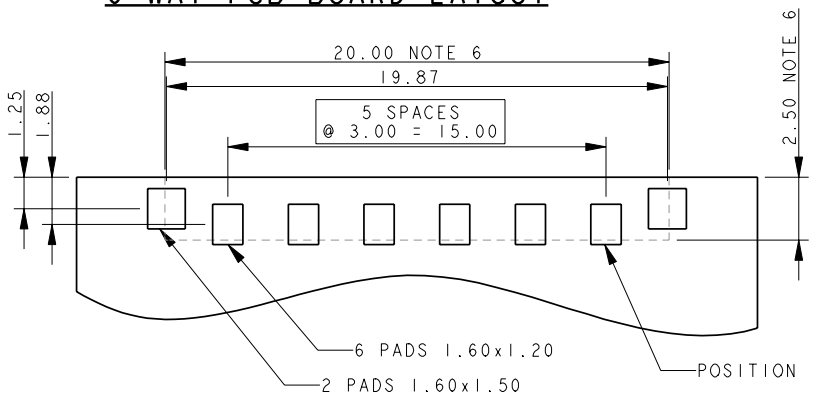

FORM-106-01-056-6 ISS 7

Release No.
History
102559

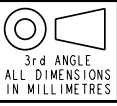

ELCO
© COPYRIGHT ELCO EUROPE
NOT TO BE DISCLOSED OR COPIED
WITHOUT WRITTEN PERMISSION

Drawn
N.C.H.

Size
CV

Description
9159 TWO PART - ORDERING CODE

Part Number
00-9159-01_100S

DATE
06-Feb-09

Issue
C

SOCKET 2 WAY 2 PART PCB STRIP CONNECTOR



MARKER IN LINE WITH POSITION I

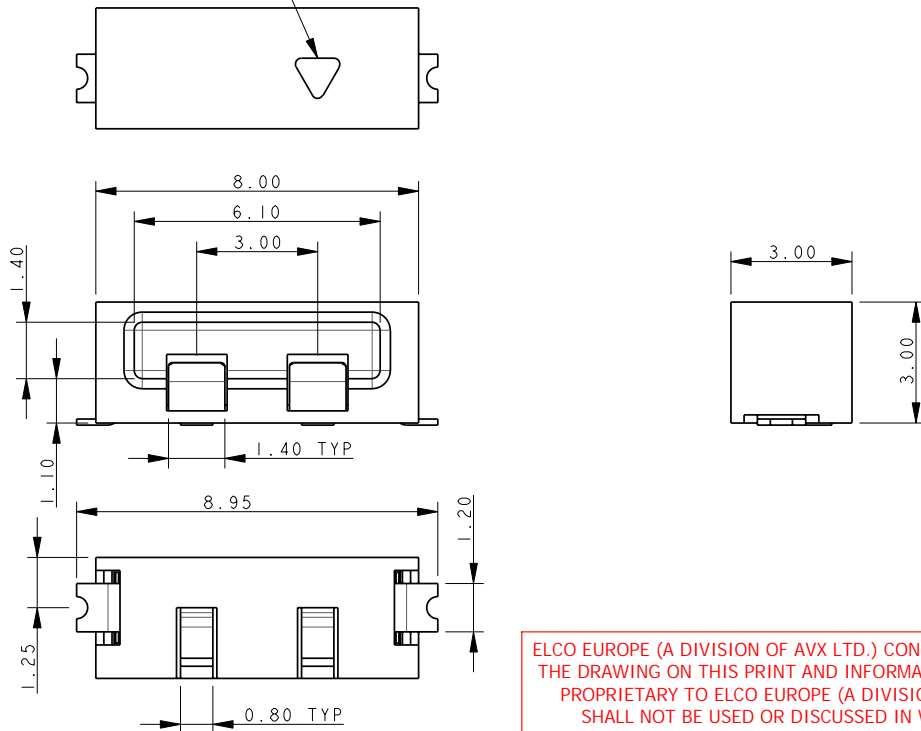

ELCO EUROPE (A DIVISION OF AVX LTD.) CONFIDENTIAL PROPRIETARY THE DRAWING ON THIS PRINT AND INFORMATION THEREWITH ARE PROPRIETARY TO ELCO EUROPE (A DIVISION OF AVX LTD.) AND SHALL NOT BE USED OR DISCUSSED IN WHOLE OR IN PART WITHOUT ELCO EUROPE'S WRITTEN CONSENT.

NOTES:

1. FOR MORE INFORMATION REFER TO PRODUCT SPEC 201-01-119.
2. DIMENSIONS ARE REFERENCE DIMENSIONS UNLESS TOLERANCED.
3. INSULATOR MATERIAL :- NYLON 46, COLOUR REFER TO SHEET 1.
4. CONTACT MATERIAL :- COPPER ALLOY, SELECTIVE GOLD OVER NICKEL TIN PLATED ON TAILS.
5. BRACKETS :- COPPER ALLOY, TIN PLATED.
6. OUTLINE OF CONNECTOR.
7. PACKING TAPE AND REEL, QUANTITY 1400 PER REEL.

PACKING DETAILS IBC

2 WAY PCB BOARD LAYOUT

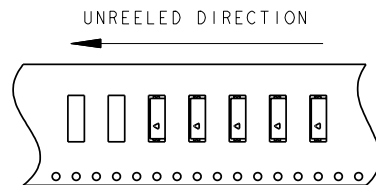
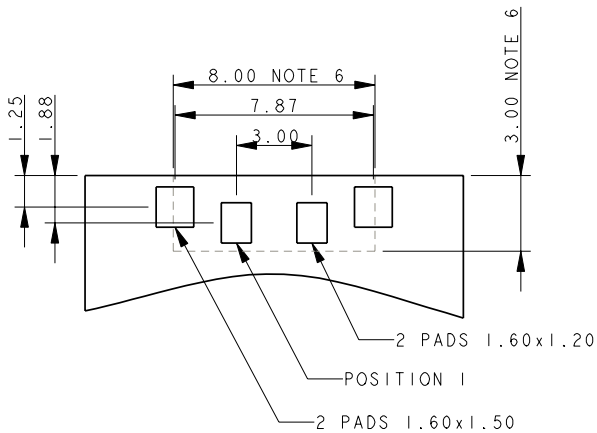

SHEET 7 OF 11

FORM-106-01-056-6 ISS 7

Release No.
History
102559



ELCO

© COPYRIGHT ELCO EUROPE
NOT TO BE DISCLOSED OR COPIED
WITHOUT WRITTEN PERMISSION

Drawn
N.C.H.

Size
CV

Description	DATE
9159 TWO PART - ORDERING CODE	09-Sep-08
Part Number	Issue
00-9159-01_100S	C

A

B

SOCKET 3 WAY 2 PART PCB STRIP CONNECTOR



MARKER IN LINE WITH POSITION 1



ELCO EUROPE (A DIVISION OF AVX LTD.) CONFIDENTIAL PROPRIETARY THE DRAWING ON THIS PRINT AND INFORMATION THEREWITH ARE PROPRIETARY TO ELCO EUROPE (A DIVISION OF AVX LTD.) AND SHALL NOT BE USED OR DISCUSSED IN WHOLE OR IN PART WITHOUT ELCO EUROPE'S WRITTEN CONSENT.

NOTES:

1. FOR MORE INFORMATION REFER TO PRODUCT SPEC 201-01-119.
2. DIMENSIONS ARE REFERENCE DIMENSIONS UNLESS TOLERANCED.
3. INSULATOR MATERIAL :- NYLON 46, COLOUR REFER TO SHEET 1.
4. CONTACT MATERIAL :- COPPER ALLOY, SELECTIVE GOLD OVER NICKEL TIN PLATED ON TAILS.
5. BRACKETS :- COPPER ALLOY, TIN PLATED.
6. OUTLINE OF CONNECTOR.
7. PACKING TAPE AND REEL, QUANTITY 1400 PER REEL.

PACKING DETAILS IBC

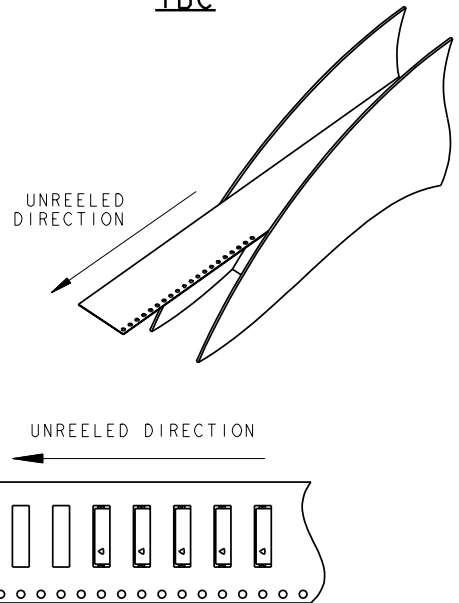

3 WAY PCB BOARD LAYOUT

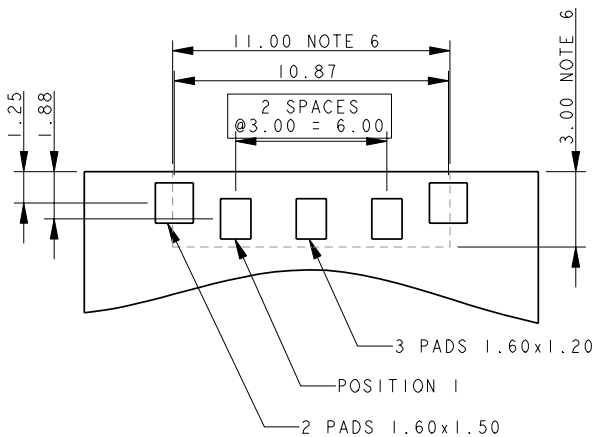

FORM-106-01-056-6 ISS 7

Release No.
History
102559

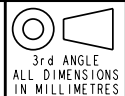

ELCO
© COPYRIGHT ELCO EUROPE
NOT TO BE DISCLOSED OR COPIED
WITHOUT WRITTEN PERMISSION

Drawn
N.C.H.
Size
CV

Description
9159 TWO PART - ORDERING CODE
Part Number
00-9159-01_100S

DATE
09-Sep-08
Issue
C

SOCKET 4 WAY 2 PART PCB STRIP CONNECTOR



ELCO EUROPE (A DIVISION OF AVX LTD.) CONFIDENTIAL PROPRIETARY
THE DRAWING ON THIS PRINT AND INFORMATION THEREWITH ARE
PROPRIETARY TO ELCO EUROPE (A DIVISION OF AVX LTD.) AND
SHALL NOT BE USED OR DISCUSSED IN WHOLE OR IN PART
WITHOUT ELCO EUROPE'S WRITTEN CONSENT.

- NOTES:
1. FOR MORE INFORMATION REFER TO PRODUCT SPEC 201-01-119.
 2. DIMENSIONS ARE REFERENCE DIMENSIONS UNLESS TOLERANCED.
 3. INSULATOR MATERIAL :- NYLON 46, COLOUR REFER TO SHEET 1.
 4. CONTACT MATERIAL :- COPPER ALLOY, SELECTIVE GOLD OVER NICKEL TIN PLATED ON TAILS.
 5. BRACKETS :- COPPER ALLOY, TIN PLATED.
 6. OUTLINE OF CONNECTOR.
 7. PACKING TAPE AND REEL, QUANTITY 1400 PER REEL.

PACKING DETAILS TBC

4 WAY PCB BOARD LAYOUT

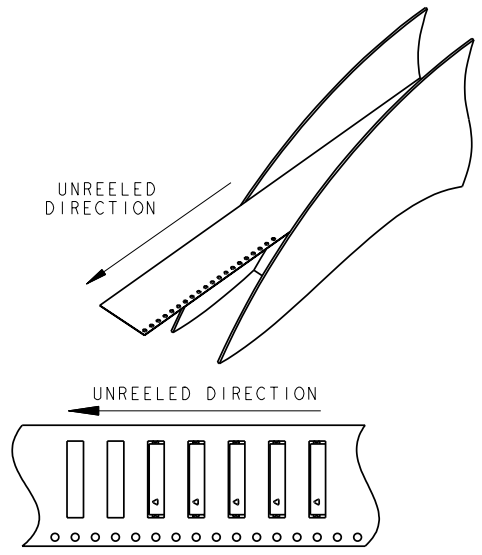

FORM-106-01-056-6 ISS 7

Release No.
History
102559



ELCO

© COPYRIGHT ELCO EUROPE
NOT TO BE DISCLOSED OR COPIED
WITHOUT WRITTEN PERMISSION

Drawn
N.C.H.

Size
CV

Description
9159 TWO PART - ORDERING CODE

Part Number
00-9159-01_100S

DATE
09-Sep-08

Issue
C

SOCKET 5 WAY 2 PART PCB STRIP CONNECTOR

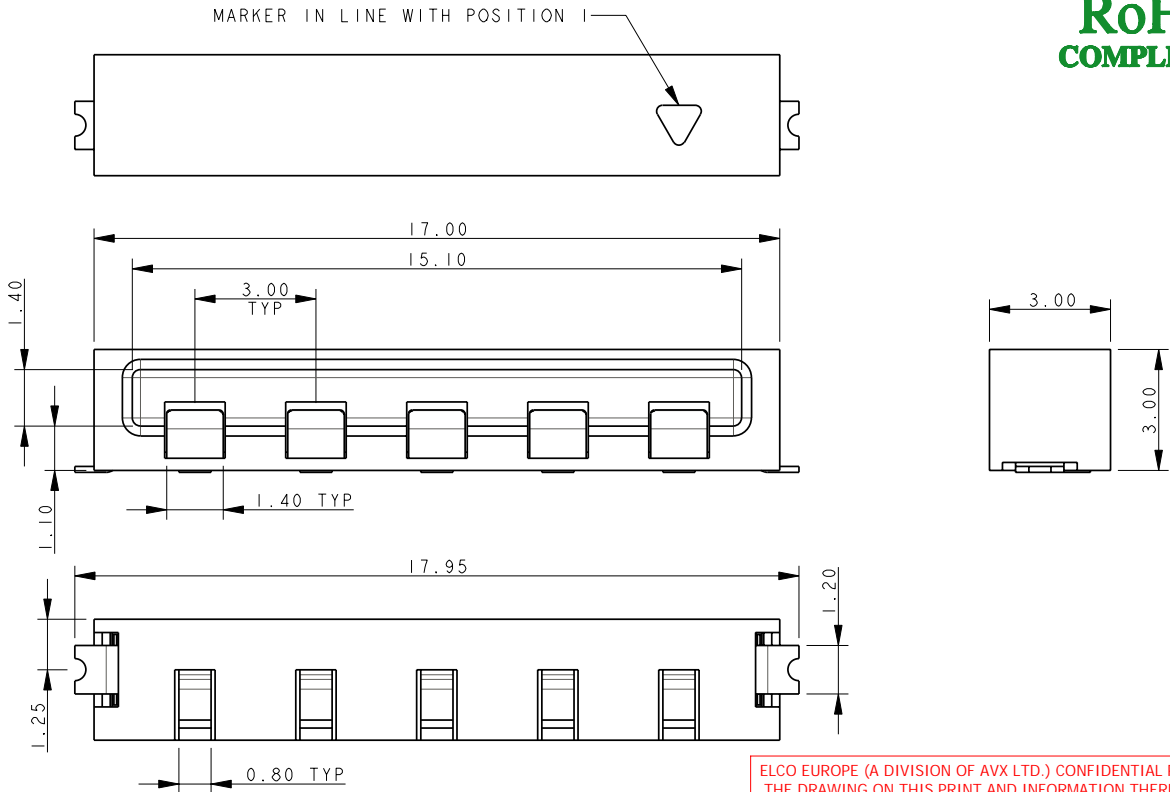

ELCO EUROPE (A DIVISION OF AVX LTD.) CONFIDENTIAL PROPRIETARY THE DRAWING ON THIS PRINT AND INFORMATION THEREWITH ARE PROPRIETARY TO ELCO EUROPE (A DIVISION OF AVX LTD.) AND SHALL NOT BE USED OR DISCUSSED IN WHOLE OR IN PART WITHOUT ELCO EUROPE'S WRITTEN CONSENT.

- NOTES:
1. FOR MORE INFORMATION REFER TO PRODUCT SPEC 201-01-119.
 2. DIMENSIONS ARE REFERENCE DIMENSIONS UNLESS TOLERANCED.
 3. INSULATOR MATERIAL :- NYLON 46, COLOUR REFER TO SHEET 1.
 4. CONTACT MATERIAL :- COPPER ALLOY, SELECTIVE GOLD OVER NICKEL TIN PLATED ON TAILS.
 5. BRACKETS :- COPPER ALLOY, TIN PLATED.
 6. OUTLINE OF CONNECTOR.
 7. PACKING TAPE AND REEL, QUANTITY 1400 PER REEL.

5 WAY PCB BOARD LAYOUT

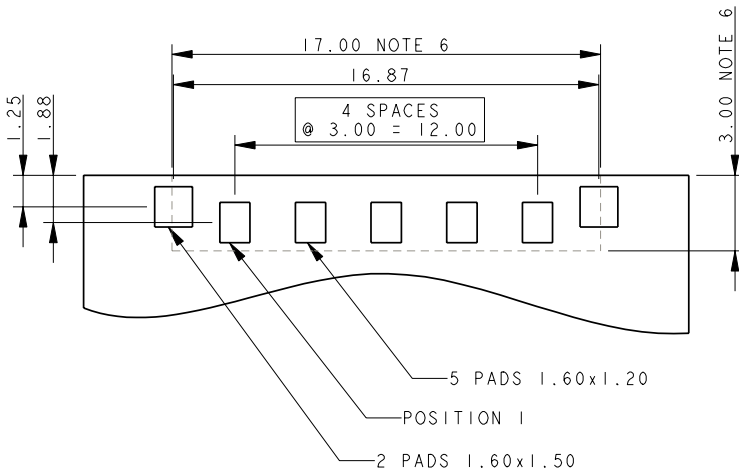

PACKING DETAILS TBC

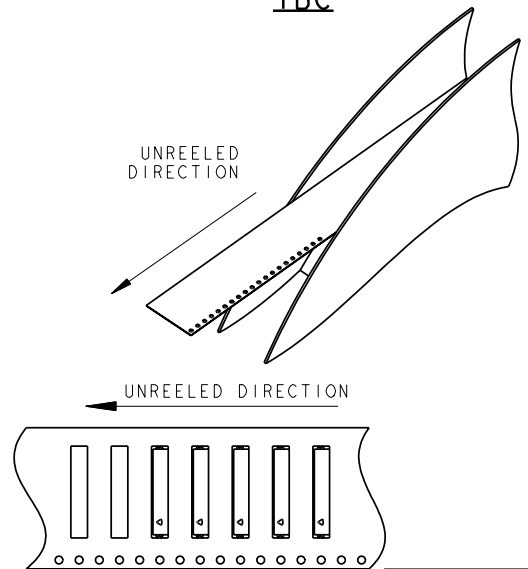

SHEET 10 OF 11

FORM-106-01-056-6 ISS 7

Release No.
History
102559

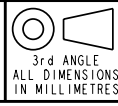

ELCO
© COPYRIGHT ELCO EUROPE
NOT TO BE DISCLOSED OR COPIED
WITHOUT WRITTEN PERMISSION

Drawn
N.C.H.

Size
CV

Description 9159 TWO PART - ORDERING CODE	DATE 09-Sep-08
Part Number 00-9159-01_100S	Issue C

A

I

B

SOCKET 6 WAY 2 PART PCB STRIP CONNECTOR

ELCO EUROPE (A DIVISION OF AVX LTD.) CONFIDENTIAL PROPRIETARY THE DRAWING ON THIS PRINT AND INFORMATION THEREWITH ARE PROPRIETARY TO ELCO EUROPE (A DIVISION OF AVX LTD.) AND SHALL NOT BE USED OR DISCUSSED IN WHOLE OR IN PART WITHOUT ELCO EUROPE'S WRITTEN CONSENT.

MARKER IN LINE WITH POSITION I



NOTES:

1. FOR MORE INFORMATION REFER TO PRODUCT SPEC 201-01-119.
2. DIMENSIONS ARE REFERENCE DIMENSIONS UNLESS TOLERANCED.
3. INSULATOR MATERIAL :- NYLON 46, COLOUR REFER TO SHEET 1.
4. CONTACT MATERIAL :- COPPER ALLOY, SELECTIVE GOLD OVER NICKEL TIN PLATED ON TAILS.
5. BRACKETS :- COPPER ALLOY, TIN PLATED.
6. OUTLINE OF CONNECTOR.
7. PACKING TAPE AND REEL, QUANTITY 1400 PER REEL.

PACKING DETAILS
TBC

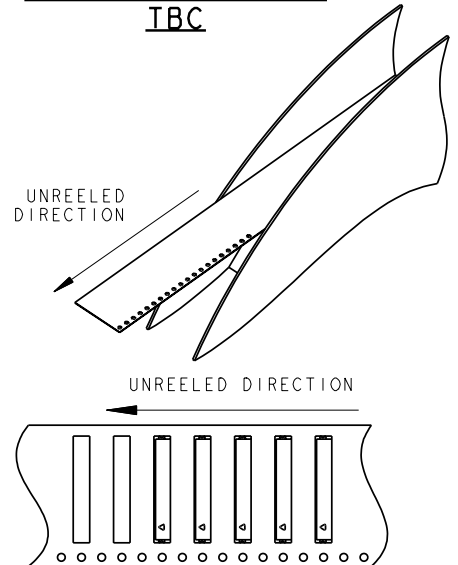

6 WAY PCB BOARD LAYOUT

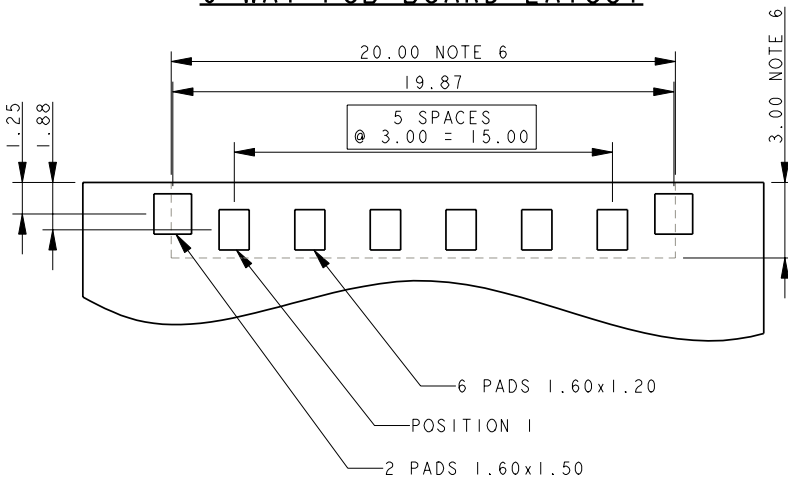

SHEET 11 OF 11

FORM-106-01-056-6 ISS 7

Release No.
History
102559

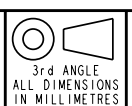

ELCO

© COPYRIGHT ELCO EUROPE
NOT TO BE DISCLOSED OR COPIED
WITHOUT WRITTEN PERMISSION

Drawn
N.C.H.

Size
CV

Description
9159 TWO PART - ORDERING CODE

Part Number
00-9159-01_100S

DATE
06-Feb-09

Issue
C

A

I

B