

High Current, Molding Power Inductors



Description

- Halogen Free
- maximum operation temperature below 125°C
- Powder iron core material
- Magnetically shielded, low EMI
- High current carrying capacity, Low core loss
- Frequency range up to 5MHz
- RoHS compliant

Applications

- Voltage Regulator Module (VRM)
- Multi-phase regulators
- Point-of-load modules
- Smart phone POL modules
- SSD modules
- Notebook regulators

Environmental Data

- Storage temperature range: -55°C to +125 °C
- Operating temperature range: -55°C to +125°C (ambient plus self-temperature rise)
- Solder reflow temperature: J-STD-020D compliant

Description												
CMKD-1360A-8R2M				8.2μH				±20 %				
Model				Inductance Value				Inductance Tolerance				
Global Part Number												
C	M	K	D	1	3	6	0	A(C,H)	8	R	2	M
Product Series				Dimensions				Material		Inductance Value		Tol.

Material A:alloy iron powder ; Material C:carbonyl iron powder. Material H :hybrid iron powder.

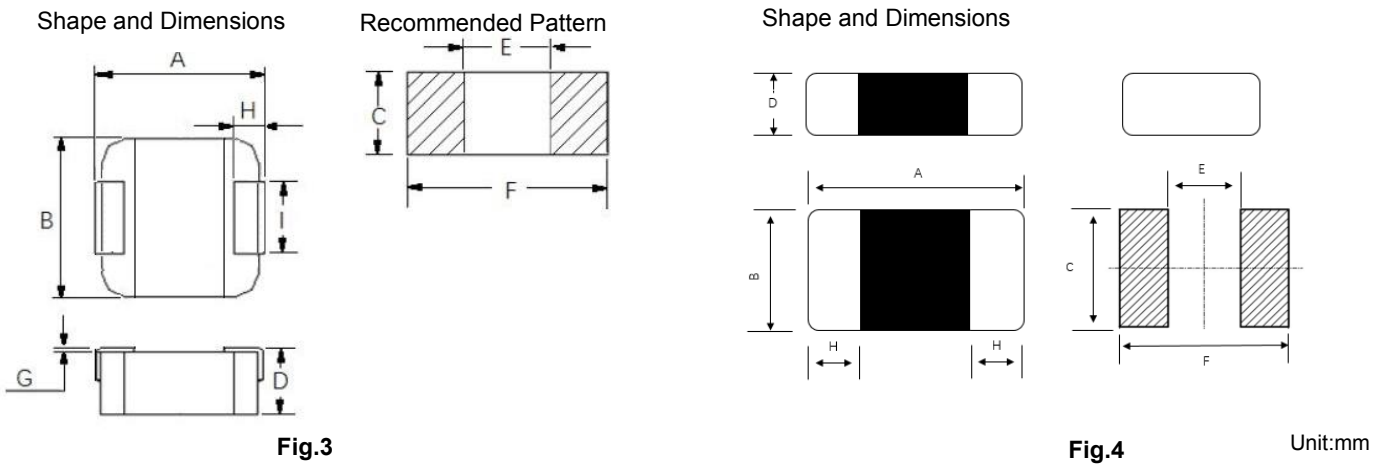
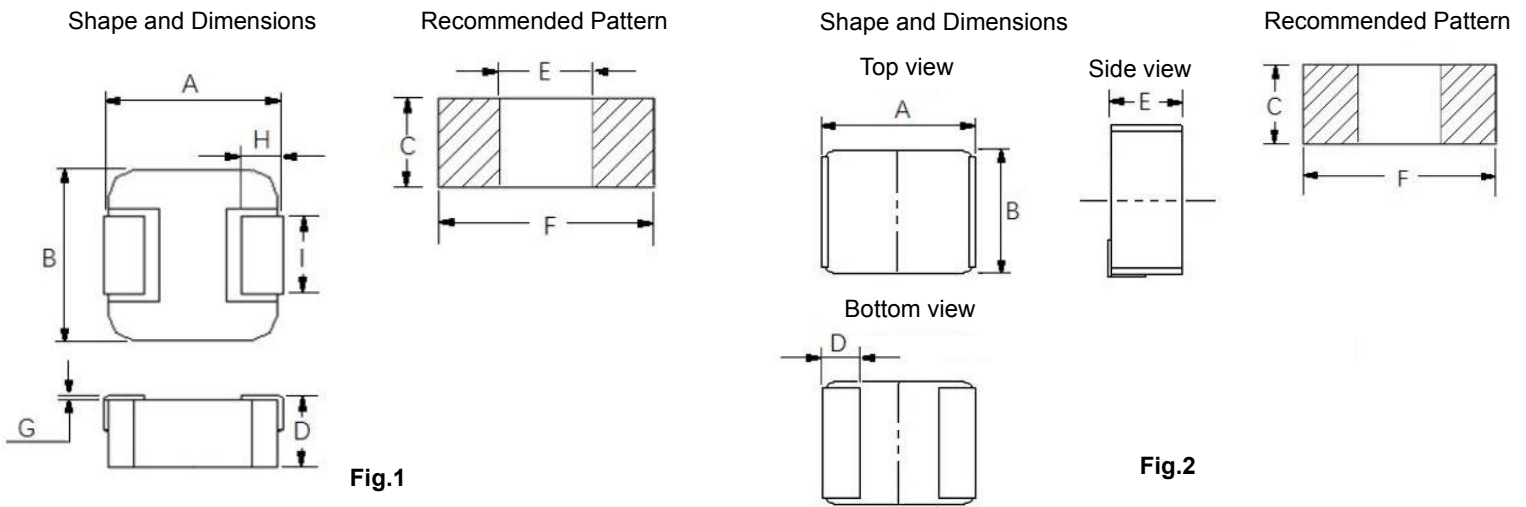

Part No.	Shape	A	B	C	D	E	F	G	H	I
CMKD-252012A-***M	Fig.4	2.5±0.2	2±0.2	2.0	1.2max	1.2	2.8	—	—	—
CMKD-0320A-***M	Fig.1	3.5±0.2	3.2±0.2	1.2	1.8±0.2	1.2	4.2	0~0.15	0.7±0.2	1.2±0.2
CMKD-0410A-***M	Fig.1	4.4±0.35	4.2±0.25	2.5	0.8±0.2	2.2	5.2	0~0.15	0.8±0.3	2±0.3
CMKD-0412A-***M	Fig.1	4.4±0.35	4.2±0.25	2.5	1±0.2	2.2	5.2	0~0.15	0.8±0.3	2±0.3
CMKD-0420A-***M	Fig.1	4.4±0.35	4.2±0.25	2.5	1.8±0.2	2.2	5.2	0~0.15	0.8±0.3	2±0.3
CMKD-0518A-***M	Fig.1	5.4±0.3	5.2±0.2	2.5	1.6±0.2	2.2	6	0~0.15	1.2±0.2	2.2±0.3
CMKD-0530A-***M	Fig.1	5.4±0.3	5.2±0.2	2.5	2.8±0.2	2.2	6	0~0.15	1.2±0.2	2.2±0.3
CMKD-0618A-***M	Fig.1	7±0.3	6.6±0.2	3.5	1.6±0.2	3.7	8.4	0~0.15	1.6±0.3	3±0.3
CMKD-0624A-***M	Fig.1	7±0.3	6.6±0.2	3.5	2.2±0.2	3.7	8.4	0~0.15	1.6±0.3	3±0.3
CMKD-0630A-***M	Fig.1	7±0.3	6.6±0.2	3.5	2.8±0.2	3.7	8.4	0~0.15	1.6±0.3	3±0.3
CMKD-0630C-***M	Fig.1	7±0.3	6.6±0.2	3.5	2.8±0.2	3.7	8.4	0~0.15	1.6±0.3	3±0.3
CMKD-0630H-***M	Fig.1	7±0.3	6.6±0.2	3.5	2.8±0.2	3.7	8.4	0~0.15	1.6±0.3	3±0.3
CMKD-0830A-***M	Fig.1	8.1±0.3	7.8±0.2	5.35	2.8±0.2	4.8	9.6	0~0.15	1.6±0.3	3±0.2
CMKD-1040A-***M	Fig.1	11.5max	10.0±0.3	4.1	3.8±0.2	5.4	13.6	0~0.15	2.0±0.5	3±0.5

Part No.	Shape	A	B	C	D	E	F	G	H	I
CMKD-1340A-***M	Fig.1	13.8max	12.8±0.5	6.0	4.0max	8	14	0~0.15	2.5±0.5	5.0±0.3
CMKD-1350A-***M	Fig.1	13.45±0.35	12.6±0.3	5	4.8±0.2	8	14.5	0~0.15	2±0.5	*
CMKD-1360A-***M	Fig.1	13.45±0.35	12.6±0.3	5	5.8±0.2	8	14.5	0~0.15	2±0.5	5.0±0.5
CMKD-1770A-***M	Fig.3	17.15±0.3	17.15max	12.32	7.0max	12.42	20.07	0~0.15	2.11±0.3	11.94±0.3

* : CMKD-1350A-R36(R50/R68/1R0/1R5/2R2)M, the size of I is 3.85±0.5mm.

CMKD-1350A-3R3 (100/220/330/470)M, the size of I is 5.0±0.5mm.

Marking

The inductor is marked with a 3-digit code

Example - -1.0→1R0

Note: Using ink for marking



Notes about electrical characteristics:

1. All test data is referenced to 25 °C ambient.
2. Operating temperature range - 55 °C to + 125 °C.
3. I_{dc}(A):DC current (A) that will cause an approximate ΔT of 40 °C (reference ambient temperature is 25 °C).
4. I_{sat}(A):DC current (A) that will cause L₀ to drop approximately 30 %.
5. The part temperature (ambient + temp rise) should not exceed 125 °C under worst case operating conditions. Circuit design, component placement, PWB trace size and thickness, airflow and other cooling provisions all affect the part temperature. Part temperature should be verified in the end application.

Electrical Characteristics

Part No.	Inductance	DC Resistance		Heating Rating Current		Saturation Current	
	L0 (μH)	DCR(mΩ)		Idc (A)		Isat (A)	
	±20 %, 1MHz, 1V	TYP.	MAX.	TYP.	MAX.	TYP.	MAX.
CMKD-252012A-R47M	0.47	29	39	4.4	3.7	4.7	3.8
CMKD-252012A-1R0M	1.0	45	59	3.5	3.0	3.8	3.0
CMKD-252012A-1R5M	1.5	60	72	2.8	2.4	3.3	2.6
CMKD-252012A-2R2M	2.2	90	108	2.3	2.0	2.7	2.2
CMKD-252012A-3R3M	3.3	120	144	1.7	1.5	2.3	1.8
CMKD-252012A-4R7M	4.7	200	240	1.5	1.3	1.9	1.5
CMKD-252012A-6R8M	6.8	310	375	1.2	1.0	1.6	1.3
CMKD-252012A-100M	10.0	400	460	1.0	0.85	1.3	1.0

Inductance vs. DC current

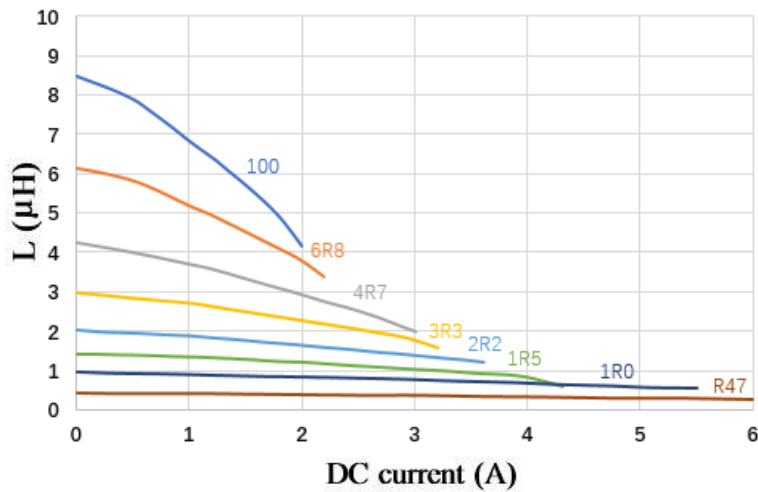

Temperature vs. DC current

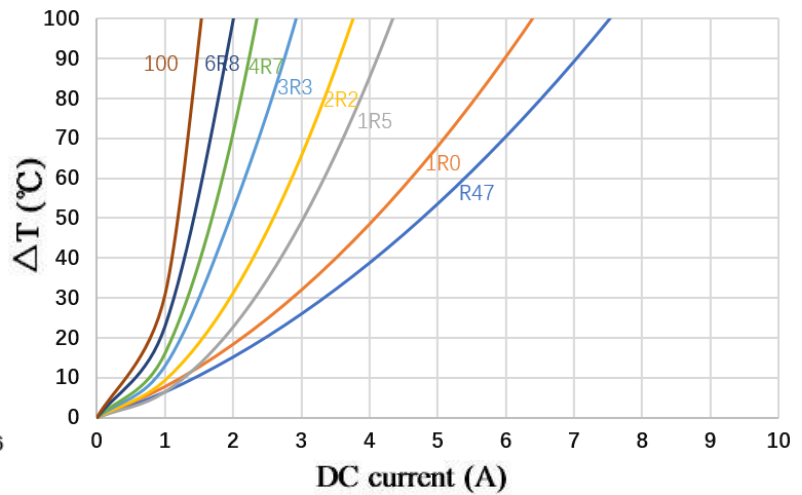

Electrical Characteristics

Part No.	Inductance	DC Resistance		Heating Rating Current	Saturation Current
	L0 (μH)	DCR (mΩ)		I _{dc} (A)	I _{sat} (A)
	±20 %, 100 kHz, 1V	TYP.	MAX.	TYP.	TYP.
CMKD-0320A-1R0M	1.0	32.0	38.0	4.0	5.0
CMKD-0320A-1R5M	1.5	40.5	48.5	3.8	4.0
CMKD-0320A-2R2M	2.2	65.0	75.0	3.5	3.7

Inductance vs. DC current

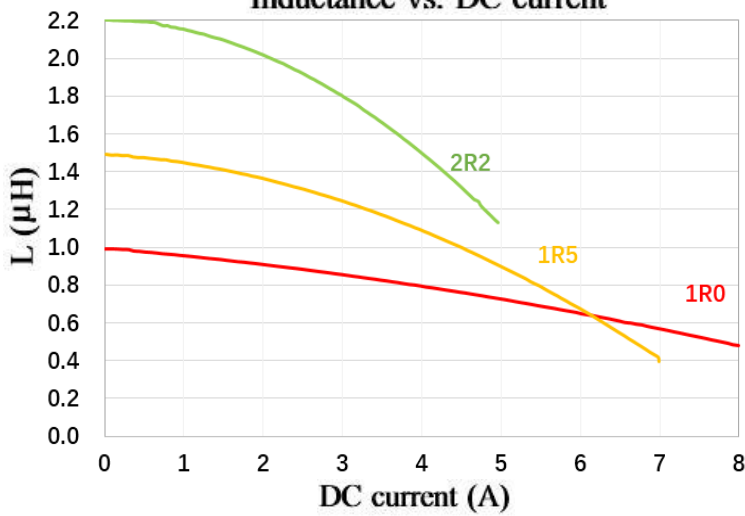

Temperature vs. DC current

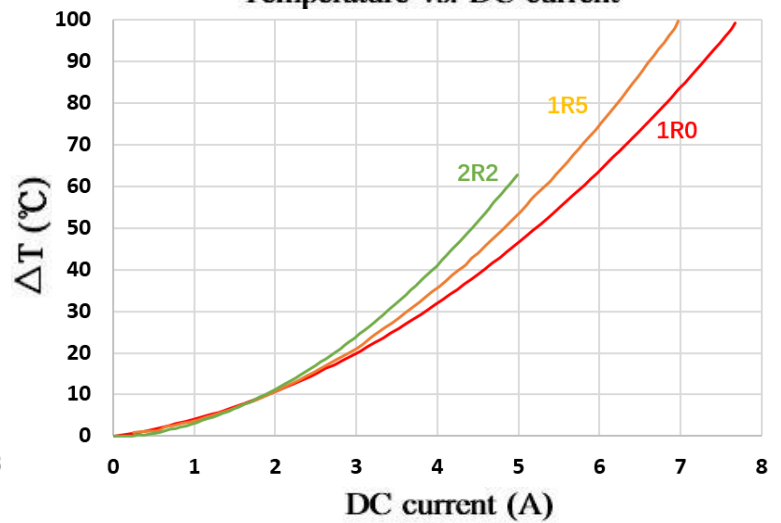

Electrical Characteristics

Part No.	Inductance	DC Resistance		Heating Rating Current	Saturation Current
	L0 (μH)	DCR (mΩ)		I _{dc} (A)	I _{sat} (A)
	±20 %, 100 kHz, 1V	TYP.	MAX.	TYP.	TYP.
CMKD-0410A-1R0M	1.0	50.0	60.0	3.0	4.0
CMKD-0410A-2R2M	2.2	92.0	110.0	2.5	3.0
CMKD-0410A-4R7M	4.7	210.0	230.0	1.8	2.0
CMKD-0410A-6R8M	6.8	190.0	215.0	1.8	1.8
CMKD-0410A-100M	10.0	265.0	335.0	1.5	1.6

Inductance vs. DC current

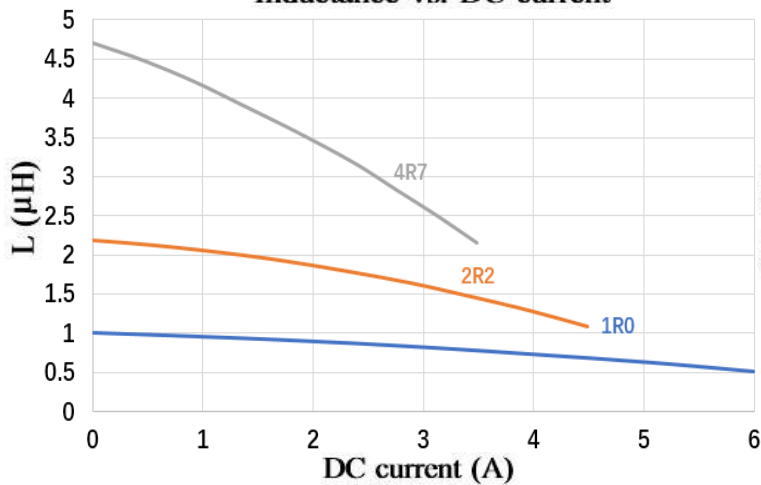

Temperature vs. DC current

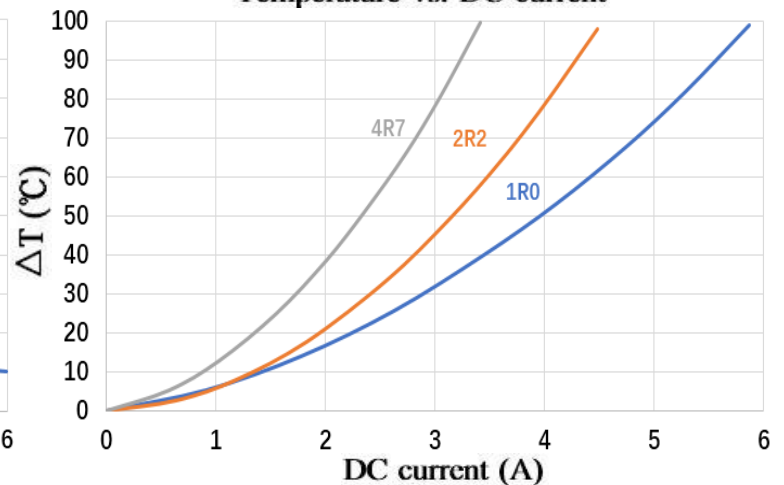

Electrical Characteristics

Part No.	Inductance	DC Resistance		Heating Rating Current	Saturation Current
	L0 (μH)	DCR (mΩ)		I _{dc} (A)	I _{sat} (A)
	±20 %, 100 kHz, 1V	TYP.	MAX.	TYP.	TYP.
CMKD-0412A-R15M	0.15	8.0	9.0	7.5	15.0
CMKD-0412A-R22M	0.22	9.5	11.0	7.0	11.0
CMKD-0412A-R33M	0.33	17.0	19.0	6.5	8.4
CMKD-0412A-R47M	0.47	19.0	21.0	6.0	6.8
CMKD-0412A-R68M	0.68	32.0	36.0	4.7	6.0
CMKD-0412A-1R0M	1.0	43.0	47.0	4.5	5.5
CMKD-0412A-1R5M	1.5	68.0	75.0	3.25	4.0
CMKD-0412A-2R2M	2.2	79.4	83.5	2.75	3.5
CMKD-0412A-4R7M	4.7	175.0	195.0	1.8	2.8

Inductance vs. DC current

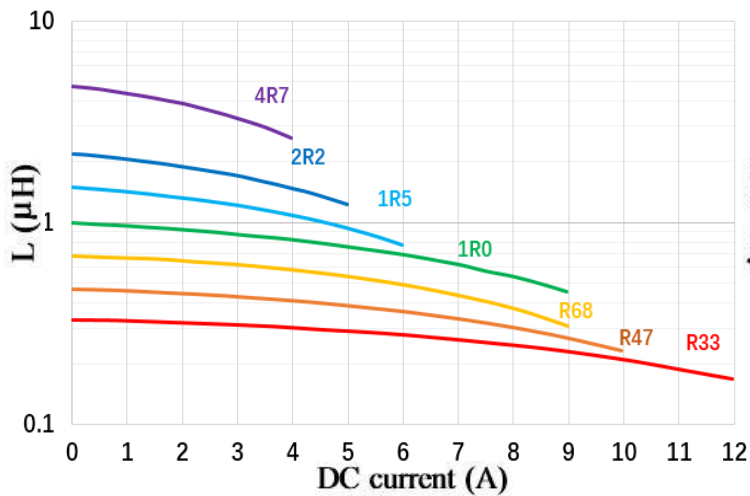

Temperature vs. DC current

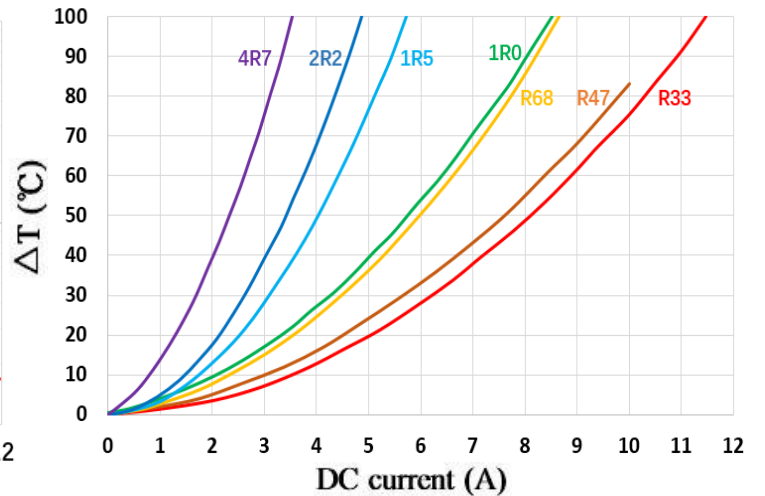

Electrical Characteristics

Part No.	Inductance	DC Resistance		Heating Rating Current	Saturation Current
	L0 (μH)	DCR (mΩ)		Idc (A)	Isat (A)
	±20 %, 100 kHz, 1V	TYP.	MAX.	TYP.	TYP.
CMKD-0420A-R10M	0.10	3.5	4.0	13.0	27.0
CMKD-0420A-R22M	0.22	6.0	6.6	9.5	21.0
CMKD-0420A-R33M	0.33	9.0	11.0	10.0	12.0
CMKD-0420A-R47M	0.47	12.5	14.0	7.5	11.0
CMKD-0420A-R56M	0.56	14.0	16.0	7.0	11.0
CMKD-0420A-R68M	0.68	16.0	18.0	7.0	8.6
CMKD-0420A-1R0M	1.0	24.0	27.0	6.0	8.0
CMKD-0420A-1R2M	1.2	24.0	27.0	6.0	7.5
CMKD-0420A-1R5M	1.5	38.0	46.0	5.0	7.0
CMKD-0420A-2R2M	2.2	52.0	58.0	4.5	5.5
CMKD-0420A-3R3M	3.3	74.0	87.0	3.3	4.5
CMKD-0420A-4R7M	4.7	92.0	105.0	2.8	3.0
CMKD-0420A-6R8M	6.8	160.0	175.0	2.4	2.8
CMKD-0420A-100M	10.0	256.0	282.0	1.6	2.2

Inductance vs. DC current

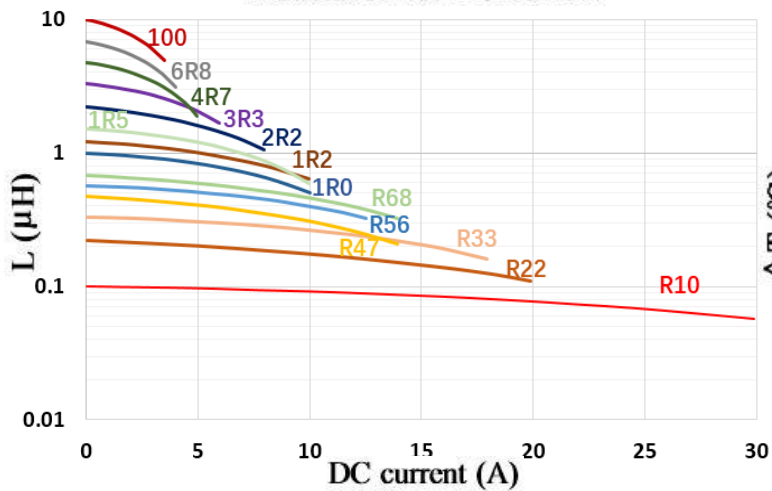

Temperature vs. DC current

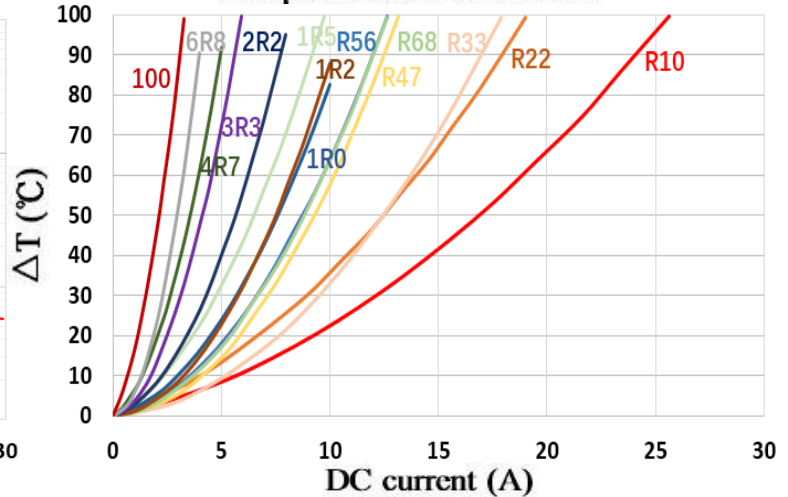

Electrical Characteristics

Part No.	Inductance	DC Resistance		Heating Rating Current	Saturation Current
	L0 (μH)	DCR (mΩ)		I _{dc} (A)	I _{sat} (A)
	±20 %, 100 kHz, 1V	TYP.	MAX.	TYP.	TYP.
CMKD-0518A-R47M	0.47	7.7	9.0	10.5	15.5
CMKD-0518A-R56M	0.56	8.0	10.0	9.5	15.0
CMKD-0518A-1R0M	1.0	15.0	17.0	8.0	9.0
CMKD-0518A-1R5M	1.5	21.0	26.0	7.5	9.0
CMKD-0518A-2R2M	2.2	30.0	35.0	5.0	6.5
CMKD-0518A-3R3M	3.3	52.0	58.0	4.5	5.0
CMKD-0518A-4R7M	4.7	78.0	85.0	3.5	4.0
CMKD-0518A-6R8M	6.8	107.0	120.0	2.8	3.4
CMKD-0518A-100M	10.0	140.0	155.0	2.5	3.0

Inductance vs. DC current

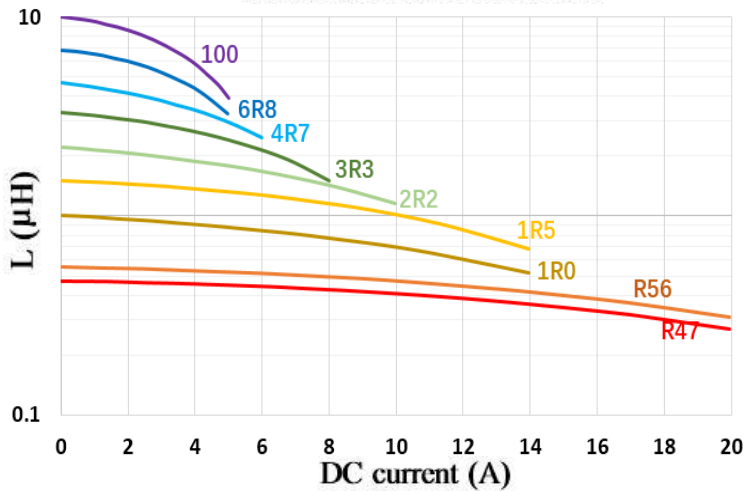

Temperature vs. DC current

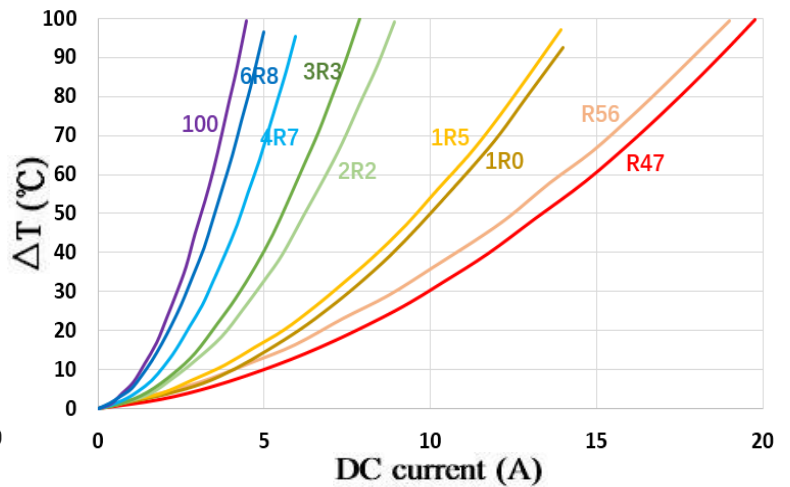

Electrical Characteristics

Part No.	Inductance	DC Resistance		Heating Rating Current	Saturation Current
	L0 (μH)	DCR (mΩ)		I _{dc} (A)	I _{sat} (A)
	±20 %, 100 kHz, 1V	TYP.	MAX.	TYP.	TYP.
CMKD-0530A-R10M	0.10	2.4	3.0	25.0	33.0
CMKD-0530A-R20M	0.20	3.5	3.9	14.0	14.5
CMKD-0530A-R47M	0.47	7.4	8.5	11.0	12.0
CMKD-0530A-R68M	0.68	11.0	12.0	9.0	11.5
CMKD-0530A-1R0M	1.0	13.0	14.0	8.5	11.0
CMKD-0530A-1R2M	1.2	15.0	16.0	8.5	11.0
CMKD-0530A-1R5M	1.5	20.0	25.0	8.2	8.5
CMKD-0530A-2R2M	2.2	25.0	29.0	7.0	7.5
CMKD-0530A-3R3M	3.3	32.0	38.0	5.5	6.0
CMKD-0530A-4R7M	4.7	50.0	60.0	4.5	5.0
CMKD-0530A-6R8M	6.8	75.0	90.0	3.5	4.0
CMKD-0530A-100M	10.0	110.0	125.0	3.2	3.5

Inductance vs. DC current

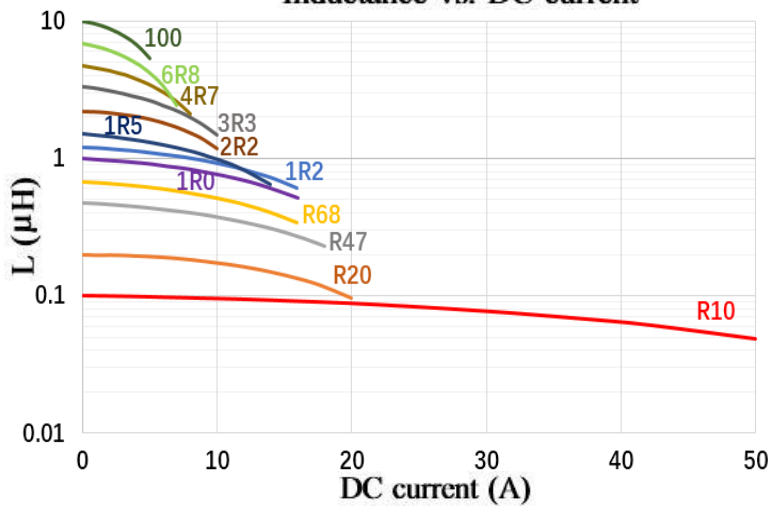

Temperature vs. DC current

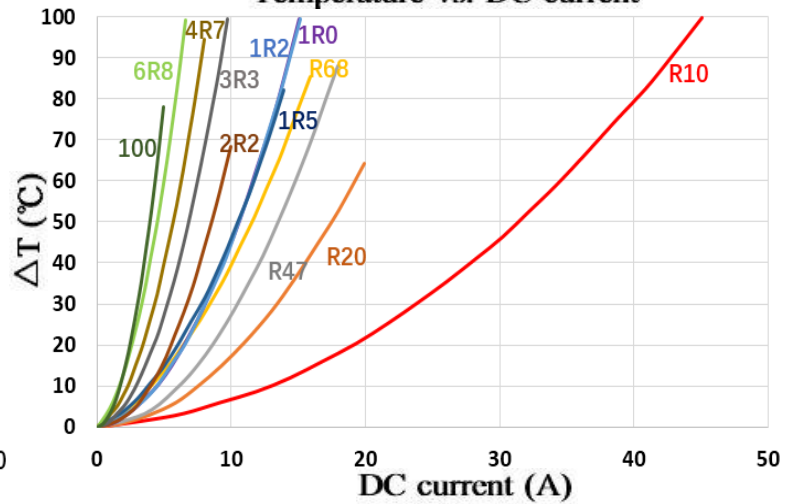

Electrical Characteristics

Part No.	Inductance	DC Resistance		Heating Rating Current	Saturation Current
	L0 (μH)	DCR (mΩ)		Idc (A)	Isat (A)
	±20 %, 100 kHz, 1V	TYP.	MAX.	TYP.	TYP.
CMKD-0618A-R47M	0.47	8.0	8.4	11.5	18.0
CMKD-0618A-R68M	0.68	10.0	12.0	9.5	17.0
CMKD-0618A-1R0M	1.0	13.0	16.0	8.5	14.0
CMKD-0618A-1R5M	1.5	20.0	26.0	8.0	12.0
CMKD-0618A-2R2M	2.2	28.0	35.0	7.0	8.0
CMKD-0618A-3R3M	3.3	43.0	50.0	4.5	6.5
CMKD-0618A-4R7M	4.7	56.0	62.0	4.0	5.0
CMKD-0618A-6R8M	6.8	101.0	110.0	3.0	4.5

Inductance vs. DC current

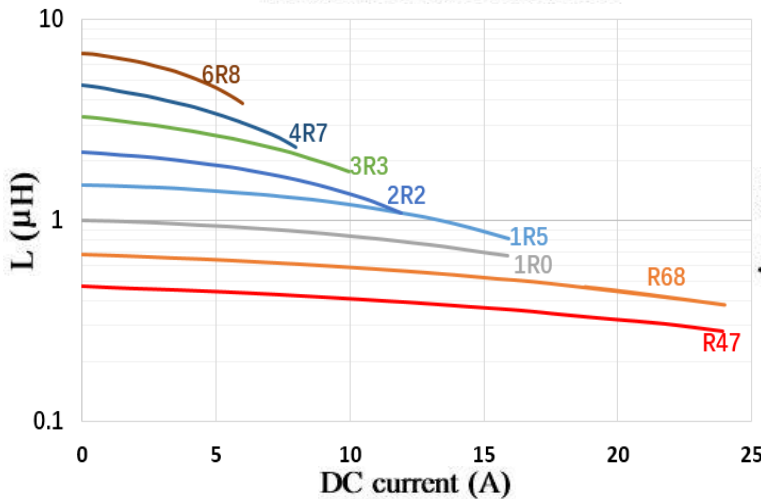

Temperature vs. DC current

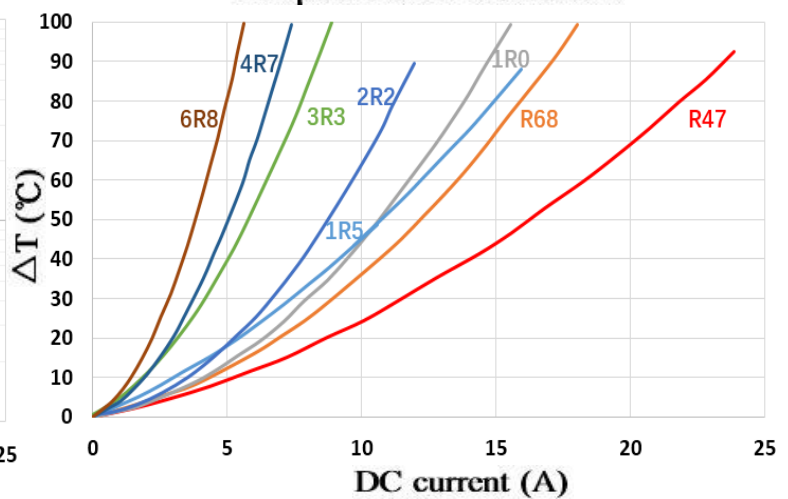

Electrical Characteristics

Part No.	Inductance	DC Resistance		Heating Rating Current	Saturation Current
	L0 (μH)	DCR (mΩ)		I _{dc} (A)	I _{sat} (A)
	±20 %, 100 kHz, 1V	TYP.	MAX.	TYP.	TYP.
CMKD-0624A-R22M	0.22	2.5	3.0	21.0	34.0
CMKD-0624A-R33M	0.33	3.5	4.1	18.0	24.5
CMKD-0624A-R47M	0.47	4.5	5.1	15.0	22.0
CMKD-0624A-R56M	0.56	5.5	6.5	13.0	17.0
CMKD-0624A-R68M	0.68	6.2	7.0	12.0	16.0
CMKD-0624A-1R0M	1.0	11.0	13.5	9.0	16.0
CMKD-0624A-1R5M	1.5	17.0	20.0	9.0	15.0
CMKD-0624A-2R2M	2.2	23.0	28.0	7.0	14.0
CMKD-0624A-3R3M	3.3	31.0	39.0	5.5	10.0
CMKD-0624A-4R7M	4.7	41.0	50.0	5.0	7.5
CMKD-0624A-6R8M	6.8	57.0	70.0	4.0	6.0
CMKD-0624A-100M	10.0	92.0	101.0	3.1	4.0
CMKD-0624A-150M	15.0	145.0	160.0	2.5	3.3
CMKD-0624A-220M	22.0	220.0	230.0	2.0	2.5

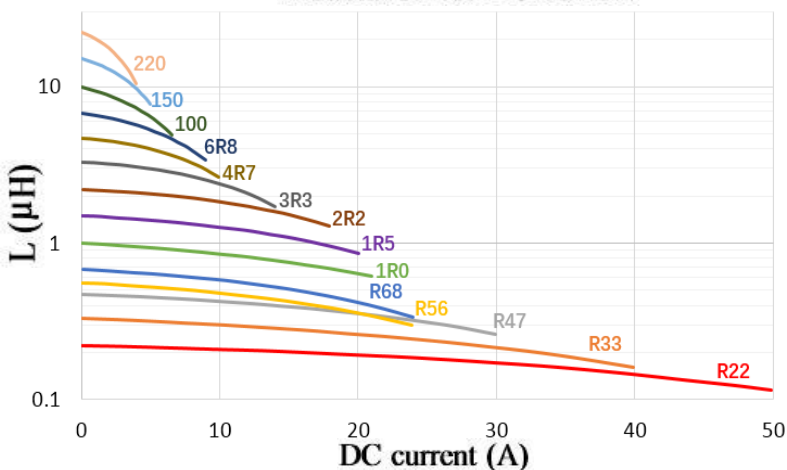
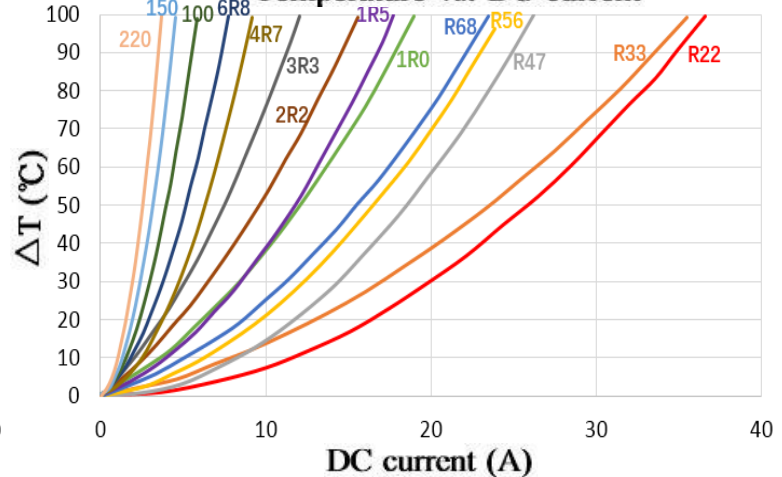
Inductance vs. DC current

Temperature vs. DC current

Electrical Characteristics

Part No.	Inductance	DC Resistance		Heating Rating Current	Saturation Current
	L0 (μH)	DCR (mΩ)		I _{dc} (A)	I _{sat} (A)
	±20 %, 100 kHz, 1V	TYP.	MAX.	TYP.	TYP.
CMKD-0630A-R22M	0.22	2.5	3.0	24.0	34.0
CMKD-0630A-R24M	0.24	2.6	3.1	23.0	26.0
CMKD-0630A-R33M	0.33	3.0	3.5	21.0	25.0
CMKD-0630A-R47M	0.47	3.5	4.1	18.0	20.0
CMKD-0630A-R56M	0.56	3.9	4.5	16.5	18.0
CMKD-0630A-R68M	0.68	4.8	5.3	16.0	17.0
CMKD-0630A-R82M	0.82	5.4	6.0	14.0	16.0
CMKD-0630A-1R0M	1.0	6.7	7.4	12.0	15.0
CMKD-0630A-1R5M	1.5	10.6	12.1	12.0	14.0
CMKD-0630A-2R2M	2.2	13.5	15.0	9.5	10.0
CMKD-0630A-3R3M	3.3	18.0	22.0	8.5	9.5
CMKD-0630A-4R7M	4.7	28.0	33.0	6.0	6.5
CMKD-0630A-5R6M	5.6	37.0	42.0	5.4	6.0
CMKD-0630A-6R8M	6.8	42.5	48.0	5.0	6.0
CMKD-0630A-8R2M	8.2	54.0	60.0	5.0	6.0
CMKD-0630A-100M	10.0	62.0	67.0	4.5	5.5
CMKD-0630A-150M	15.0	104.0	115.0	3.0	4.5
CMKD-0630A-220M	22.0	180.0	200.0	2.3	3.0
CMKD-0630A-330M	33.0	280.0	310.0	2.0	2.5

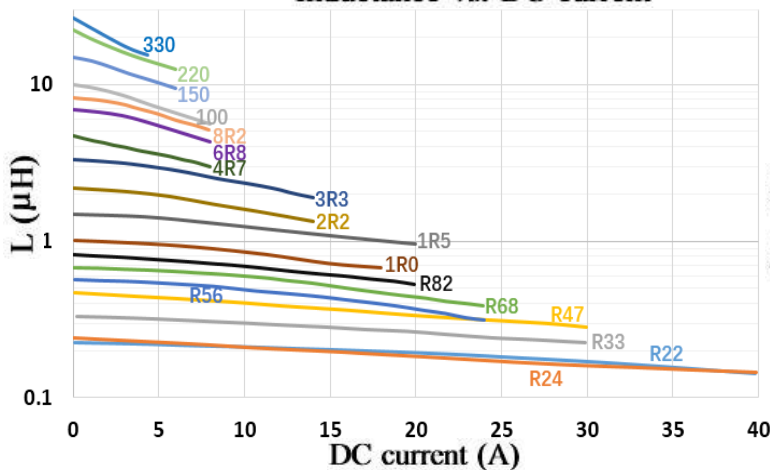
Inductance vs. DC current



Temperature vs. DC current

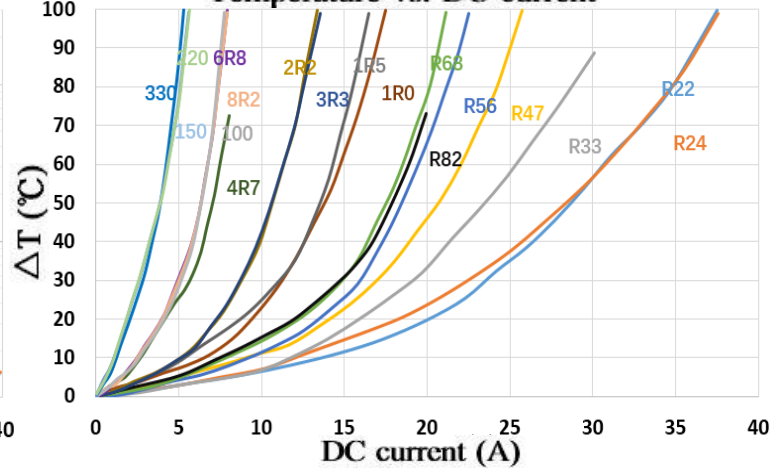

Electrical Characteristics

Part No.	Inductance	DC Resistance		Heating Rating Current	Saturation Current
	L0 (μH)	DCR (mΩ)		I _{dc} (A)	I _{sat} (A)
	±20 %, 100 kHz, 1V	TYP.	MAX.	TYP.	TYP.
CMKD-0630C-R10M	0.10	1.5	1.7	32.5	60.0
CMKD-0630C-R15M	0.15	1.7	2.0	30.0	52.0
CMKD-0630C-R20M	0.20	2.4	3.0	24.0	41.0
CMKD-0630C-R22M	0.22	2.5	2.8	23.0	40.0
CMKD-0630C-R33M	0.33	3.5	3.9	20.0	30.0
CMKD-0630C-R47M	0.47	4.0	4.2	17.5	26.0
CMKD-0630C-R56M	0.56	4.7	5.0	16.5	25.5
CMKD-0630C-R68M	0.68	5.0	5.5	15.5	25.0
CMKD-0630C-R75M	0.75	5.4	6.2	14.0	24.5
CMKD-0630C-R82M	0.82	6.7	8.0	13.0	24.0
CMKD-0630C-1R0M	1.0	9.0	10.0	11.0	22.0
CMKD-0630C-1R2M	1.2	10.0	12.0	10.0	20.0
CMKD-0630C-1R5M	1.5	14.0	15.0	9.0	18.0
CMKD-0630C-2R0M	2.0	16.0	18.0	8.2	14.0
CMKD-0630C-2R2M	2.2	18.0	20.0	8.0	14.0
CMKD-0630C-2R5M	2.5	20.0	22.0	7.0	14.0
CMKD-0630C-3R3M	3.3	28.0	30.0	6.0	13.5
CMKD-0630C-4R7M	4.7	37.0	40.0	5.5	10.0
CMKD-0630C-6R8M	6.8	54.0	60.0	4.5	8.0

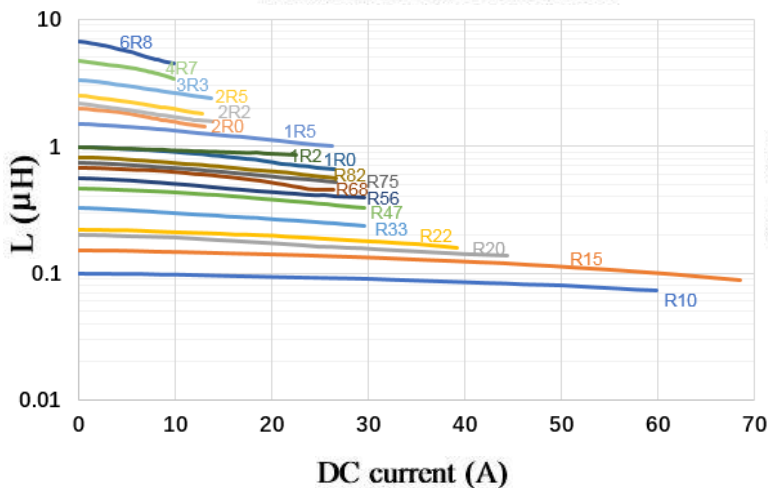
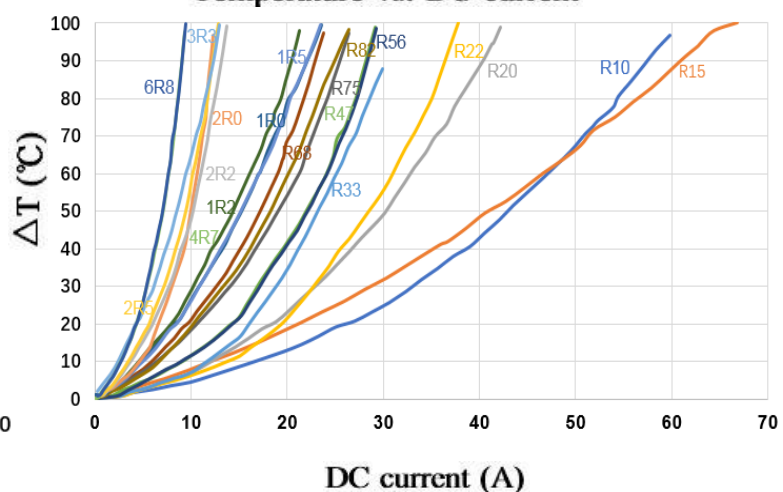
Inductance vs. DC current

Temperature vs. DC current

Electrical Characteristics

Part No.	Inductance	DC Resistance		Heating Rating Current	Saturation Current
	L0 (μH)	DCR (mΩ)		I _{dc} (A)	I _{sat} (A)
	±20 %, 100 kHz, 1V	TYP.	MAX.	TYP.	TYP.
CMKD-0630H-R15M	0.15	0.85	0.98	33.0	62.0
CMKD-0630H-R22M	0.22	0.98	1.15	32.0	44.0
CMKD-0630H-R33M	0.33	2.6	3.0	21.0	36.0
CMKD-0630H-R47M	0.47	3.4	3.9	20.0	23.0
CMKD-0630H-R68M	0.68	3.8	4.4	16.0	19.0
CMKD-0630H-R82M	0.82	4.7	5.4	14.5	17.0
CMKD-0630H-1R0M	1.0	5.6	6.5	14.5	18.0
CMKD-0630H-1R5M	1.5	7.7	8.7	11.0	16.5
CMKD-0630H-2R2M	2.2	11.0	12.8	10.0	14.0
CMKD-0630H-3R3M	3.3	15.5	18.0	7.5	12.5
CMKD-0630H-4R7M	4.7	23.0	26.0	7.0	8.0
CMKD-0630H-5R6M	5.6	28.5	33.0	5.5	8.0
CMKD-0630H-6R8M	6.8	36.0	42.0	5.0	7.5
CMKD-0630H-100M	10.0	54.0	62.0	4.0	6.5
CMKD-0630H-150M	15.0	91.0	110.0	3.5	6.2
CMKD-0630H-220M	22.0	132.0	150.0	2.5	4.5
CMKD-0630H-330M	33.0	228.0	270.0	1.8	3.5

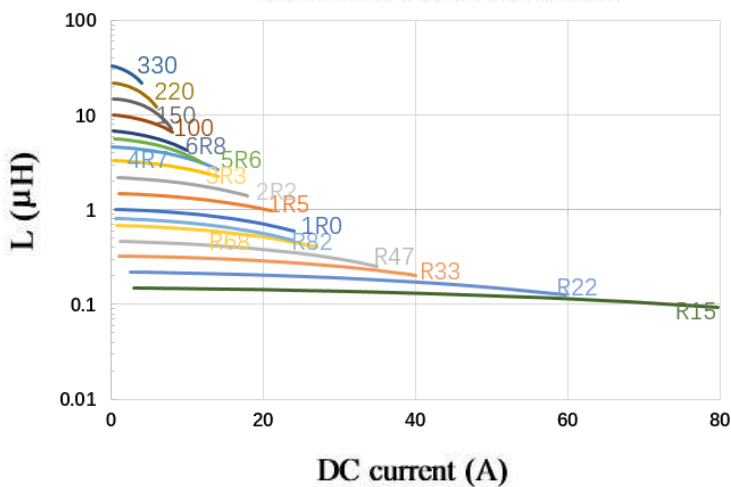
Inductance vs. DC current



Temperature vs. DC current

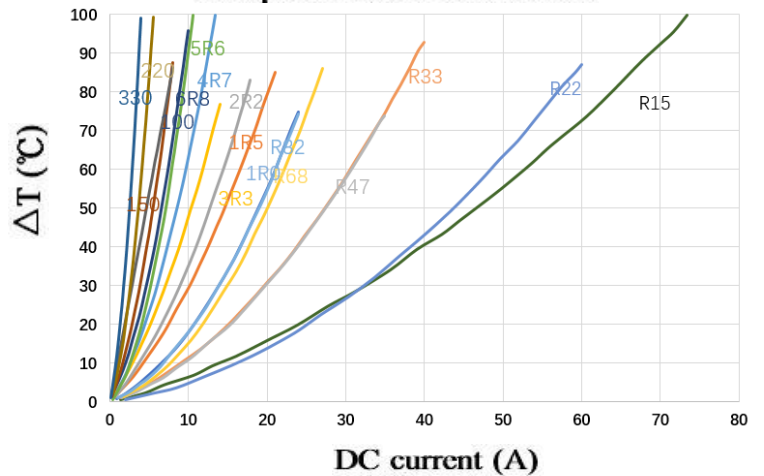

Electrical Characteristics

Part No.	Inductance	DC Resistance		Heating Rating Current	Saturation Current
	L0 (μH)	DCR(mΩ)		I _{dc} (A)	I _{sat} (A)
	±20 %, 100 kHz, 1V	TYP.	MAX.	TYP.	TYP.
CMKD-0830A-R22M	0.22	1.9	2.3	27.0	36.0
CMKD-0830A-R33M	0.33	2.2	2.6	25.0	28.0
CMKD-0830A-R47M	0.47	2.6	3.1	23.0	23.5
CMKD-0830A-R68M	0.68	3.6	4.3	20.0	20.7
CMKD-0830A-R82M	0.82	3.9	4.7	19.0	18.0
CMKD-0830A-1R0M	1.0	4.5	5.4	17.0	17.0
CMKD-0830A-1R2M	1.2	5.6	6.7	16.0	15.3
CMKD-0830A-1R5M	1.5	7.8	9.3	11.5	15.0
CMKD-0830A-1R8M	1.8	7.1	8.5	14.0	12.2
CMKD-0830A-2R2M	2.2	10.8	13.0	10.0	11.7
CMKD-0830A-3R3M	3.3	16.2	19.0	9.5	9.5
CMKD-0830A-4R7M	4.7	26.0	31.0	6.6	8.6
CMKD-0830A-5R6M	5.6	29.0	35.0	6.3	6.8
CMKD-0830A-6R8M	6.8	36.0	43.0	6.0	6.3
CMKD-0830A-8R2M	8.2	45.0	54.0	5.0	6.0
CMKD-0830A-100M	10.0	60.0	72.0	4.5	5.4
CMKD-0830A-150M	15.0	84.0	100.0	3.6	4.7
CMKD-0830A-220M	22.0	120.0	145.0	3.0	3.9
CMKD-0830A-330M	33.0	170.0	204.0	2.5	3.2

Inductance vs. DC current

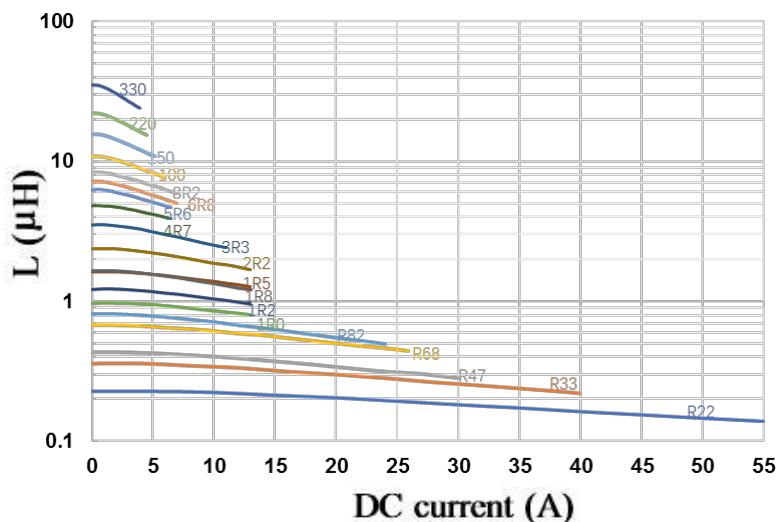

Temperature vs. DC current

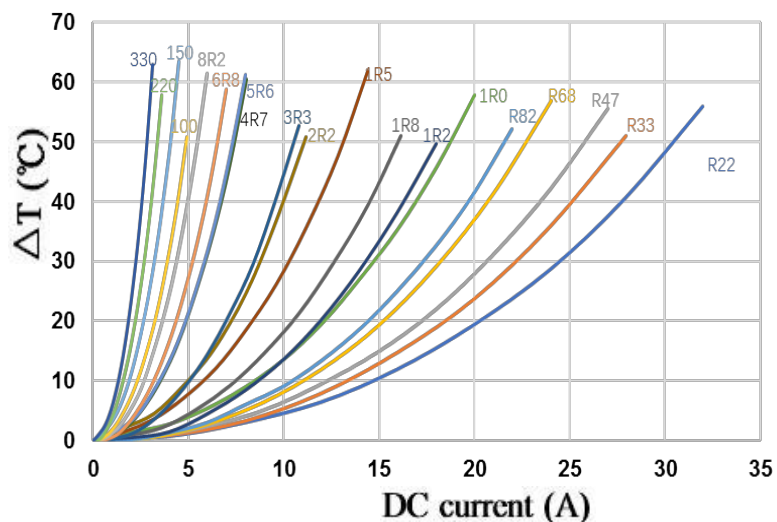

Electrical Characteristics

Part No.	Inductance	DC Resistance		Heating Rating Current	Saturation Current
	L0 (μH)	DCR (mΩ)		Idc (A)	Isat (A)
	±20 %, 100 kHz, 1V	TYP.	MAX.	TYP.	TYP.
CMKD-1040A-R15M	0.15	0.5	0.65	45.0	75.0
CMKD-1040A-R22M	0.22	0.9	1.0	35.0	60.0
CMKD-1040A-R30M	0.30	0.95	1.1	35.0	50.0
CMKD-1040A-R36M	0.36	1.05	1.2	30.0	50.0
CMKD-1040A-R47M	0.47	1.5	1.7	30.0	40.0
CMKD-1040A-R56M	0.56	1.6	1.8	25.0	33.0
CMKD-1040A-R68M	0.68	2.1	2.4	23.0	30.0
CMKD-1040A-R80M	0.80	2.6	2.7	23.0	29.0
CMKD-1040A-1R0M	1.0	3.0	3.3	19.0	28.0
CMKD-1040A-1R5M	1.5	3.8	4.2	16.0	26.0
CMKD-1040A-2R2M	2.2	6.0	7.0	12.0	18.0
CMKD-1040A-3R3M	3.3	10.0	11.8	11.0	16.0
CMKD-1040A-4R7M	4.7	17.0	20.0	9.0	15.0
CMKD-1040A-6R8M	6.8	22.0	25.0	8.5	12.0
CMKD-1040A-8R2M	8.2	25.0	27.0	8.0	9.0
CMKD-1040A-100M	10.0	27.0	30.0	7.8	8.5
CMKD-1040A-150M	15.0	40.0	45.0	6.5	7.0
CMKD-1040A-220M	22.0	58.0	66.0	5.0	5.5
CMKD-1040A-330M	33.0	85.0	92.0	4.4	5.0
CMKD-1040A-470M	47.0	130.0	145.0	3.3	3.5
CMKD-1040A-680M	68.0	178.0	195.0	2.5	3.0
CMKD-1040A-101M	100	315.0	350.0	2.2	2.3

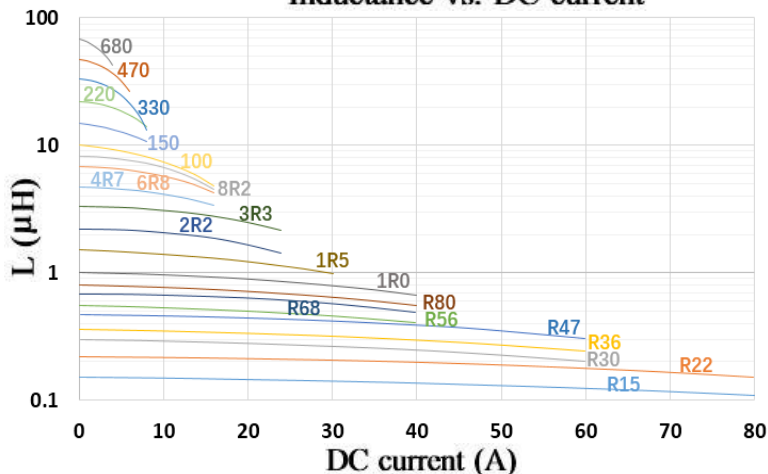
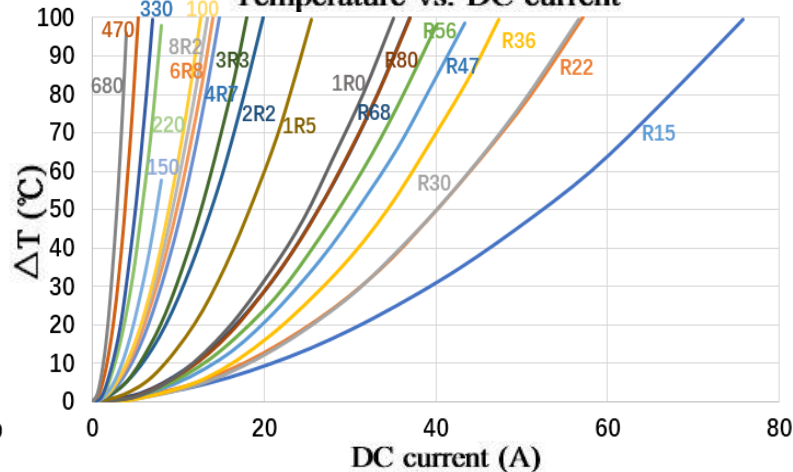
Inductance vs. DC current

Temperature vs. DC current

Electrical Characteristics

Part No.	Inductance	DC Resistance	Heating Rating Current	Saturation Current
	L0 (μH)	DCR (mΩ)	I _{dc} (A)	I _{sat} (A)
	±20 %, 100 kHz, 0.1V	MAX.	TYP.	MAX
CMKD-1340A-R22M	0.22	0.9	42.0	50.0
CMKD-1340A-R47M	0.47	2.0	33.0	48.0
CMKD-1340A-R68M	0.68	3.5	28.0	47.0
CMKD-1340A-R82M	0.82	4.5	28.0	40.0
CMKD-1340A-1R0M	1.0	7.5	24.0	35.0
CMKD-1340A-1R5M	1.5	9.5	20.0	30.5
CMKD-1340A-2R2M	2.2	11.5	18.0	26.0
CMKD-1340A-3R3M	3.3	13.0	15.0	21.0
CMKD-1340A-4R7M	4.7	14.5	13.0	18.0
CMKD-1340A-6R8M	6.8	20.0	9.0	14.0
CMKD-1340A-100M	10.0	25.0	8.0	10.0
CMKD-1340A-150M	15.0	39.0	6.5	7.5
CMKD-1340A-220M	22.0	51.0	4.5	6.0

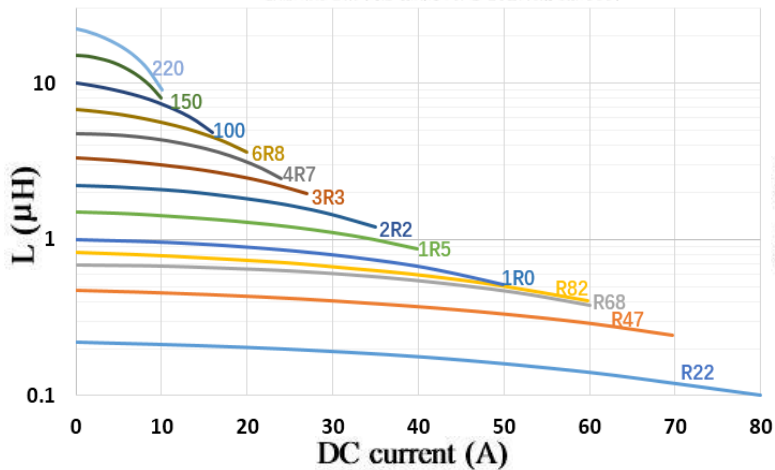
Inductance vs. DC current



Temperature vs. DC current

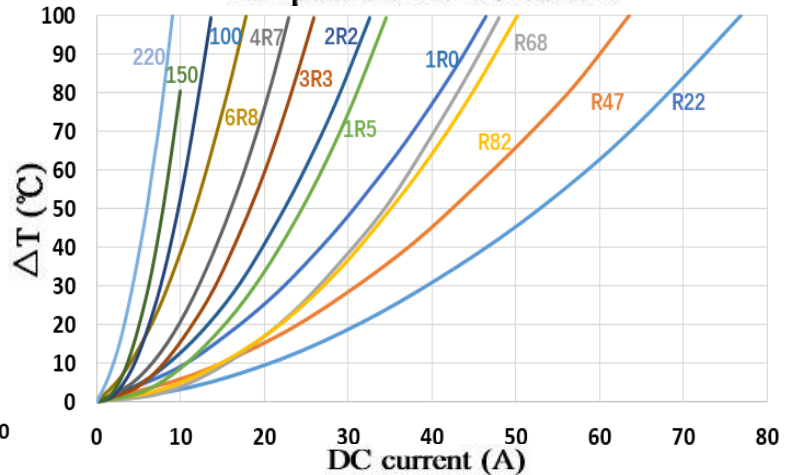

Electrical Characteristics

Part No.	Inductance	DC Resistance		Heating Rating Current	Saturation Current
	L0 (μH)	DCR (mΩ)		I _{dc} (A)	I _{sat} (A)
	±20 %, 100 kHz, 1V	TYP.	MAX.	TYP.	TYP.
CMKD-1350A-R22M	0.22	0.5	0.7	50.0	75.0
CMKD-1350A-R36M	0.36	0.74	0.85	42.0	50.0
CMKD-1350A-R50M	0.5	1.1	1.15	38.0	48.0
CMKD-1350A-R68M	0.68	1.35	1.55	33.0	46.0
CMKD-1350A-R82M	0.82	1.45	1.67	30.0	39.0
CMKD-1350A-1R0M	1.0	1.9	2.2	26.0	35.0
CMKD-1350A-1R5M	1.5	2.8	3.2	23.0	33.0
CMKD-1350A-2R2M	2.2	4.0	5.0	15.0	24.0
CMKD-1350A-3R3M	3.3	5.9	7.0	14.0	22.0
CMKD-1350A-4R7M	4.7	8.2	9.0	13.0	21.0
CMKD-1350A-6R8M	6.8	14.5	18.0	12.0	16.0
CMKD-1350A-100M	10.0	19.0	22.0	9.0	12.0
CMKD-1350A-150M	15.0	23.0	30.0	8.0	10.0
CMKD-1350A-220M	22.0	51.0	58.0	4.5	6.5
CMKD-1350A-330M	33.0	75.0	84.0	3.5	6.0
CMKD-1350A-470M	47.0	116.0	130.0	3.0	5.0

Inductance vs. DC current

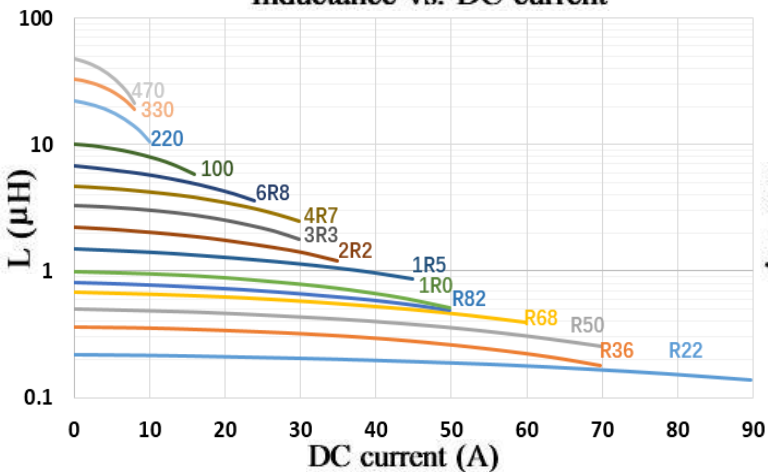

Temperature vs. DC current

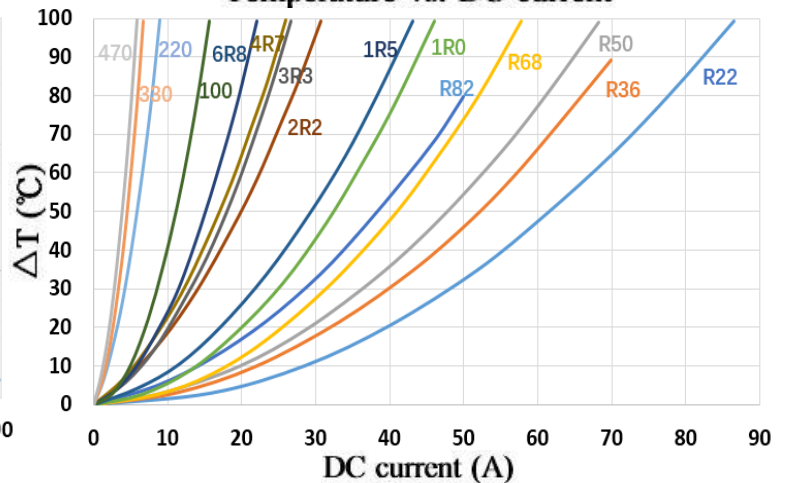

Electrical Characteristics

Part No.	Inductance	DC Resistance		Heating Rating Current	Saturation Current
	L0 (μH)	DCR (mΩ)		Idc (A)	Isat (A)
	±20 %, 100 kHz, 1V	TYP.	MAX.	TYP.	TYP.
CMKD-1360A-4R7M	4.7	8.5	9.0	20.0	24.0
CMKD-1360A-5R6M	5.6	9.5	11.0	18.0	22.5
CMKD-1360A-8R2M	8.2	13.6	16	11.0	13.5
CMKD-1360A-100M	10.0	18.0	20.7	10.0	12.5
CMKD-1360A-120M	12.0	20	23	7.0	10.0
CMKD-1360A-150M	15.0	25	29	6.0	9.0
CMKD-1360A-180M	18.0	30	35	5.0	8.0
CMKD-1360A-220M	22.0	34	39.5	5.0	7.5
CMKD-1360A-270M	27.0	49	56	4.0	6.5
CMKD-1360A-330M	33.0	65	75	4.0	6.0
CMKD-1360A-470M	47.0	80	90	3.5	5.5
CMKD-1360A-680M	68.0	120	140	3.0	4.5
CMKD-1360A-101M	100.0	180	200	2.5	3.5
CMKD-1360A-121M	120.0	210	235	2.3	3.2
CMKD-1360A-151M	150.0	300	350	2.0	2.7

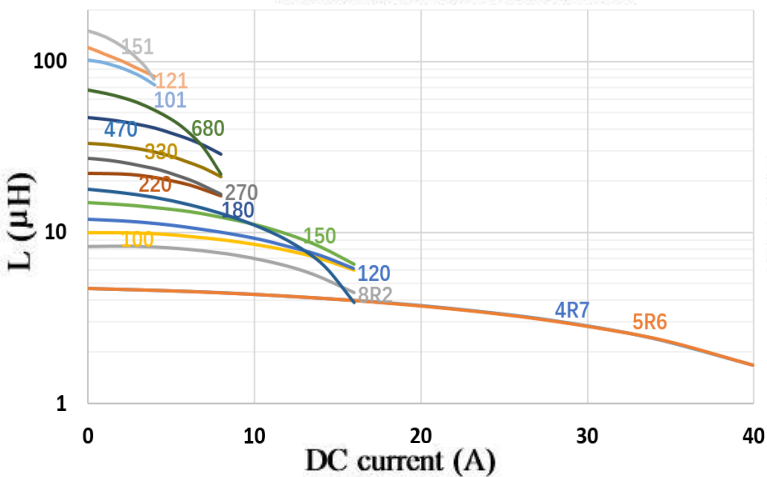
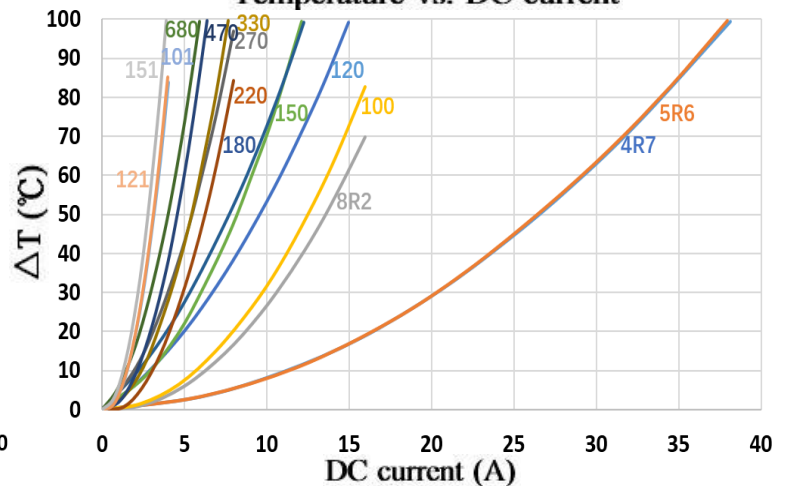
Inductance vs. DC current

Temperature vs. DC current

Electrical Characteristics

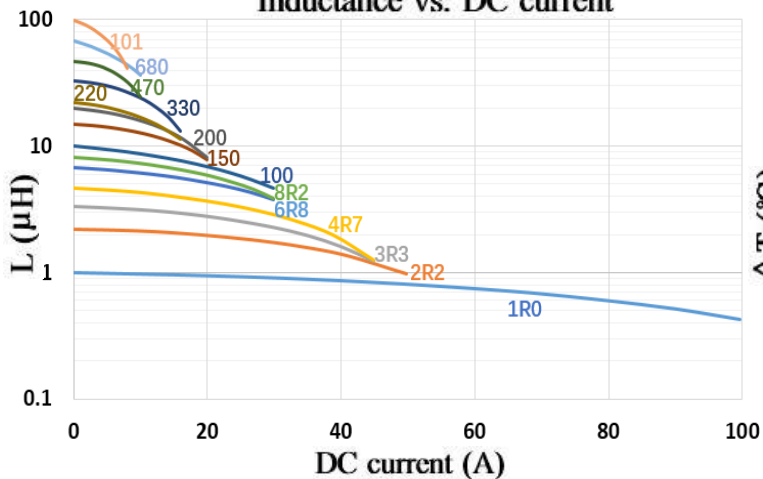
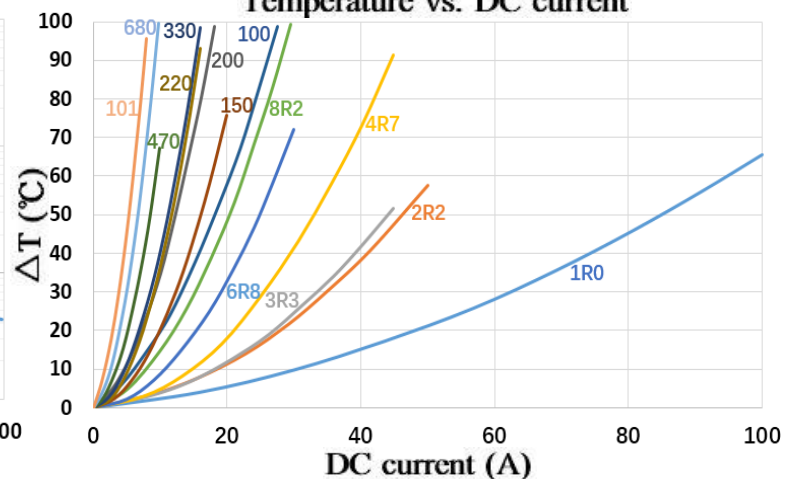
Part No.	Inductance	DC Resistance		Heating Rating Current	Saturation Current
	L0 (μH)	DCR (mΩ)		Idc (A)	Isat (A)
	±20 %, 100 kHz, 1V	TYP.	MAX.	TYP.	TYP.
CMKD-1770A-R47M	0.47	0.78	0.9	57.0	85.5
CMKD-1770A-1R0M	1.0	1.3	1.5	44.6	60.8
CMKD-1770A-2R2M	2.2	2.15	2.5	37.0	34.0
CMKD-1770A-3R3M	3.3	2.79	2.93	35.0	27.0
CMKD-1770A-4R7M	4.7	4.12	4.72	27.0	24.0
CMKD-1770A-6R8M	6.8	6.55	7.55	20.0	22.0
CMKD-1770A-8R2M	8.2	8.1	8.7	16.0	20.0
CMKD-1770A-100M	10.0	9.3	10.0	14.0	18.0
CMKD-1770A-150M	15.0	16.5	17.5	13.0	14.5
CMKD-1770A-200M	20.0	19.5	21.9	9.7	12.0
CMKD-1770A-220M	22.0	20.5	23.0	9.5	11.0
CMKD-1770A-330M	33.0	35.1	37.0	9.0	10.0
CMKD-1770A-470M	47.0	41.0	47.0	6.8	7.5
CMKD-1770A-680M	68.0	74.0	85.0	5.2	6.5
CMKD-1770A-101M	100.0	100.0	120.0	4.0	4.5

Inductance vs. DC current

Temperature vs. DC current

Mechanical Reliability		
Item	Specification and Requirement	Test Method
Solderability	The surface of terminal immersed shall be minimum of 95% covered with a new coating of solder	Solder heat proof: 1. Preheating: $160 \pm 10 \text{ }^\circ\text{C}$ 2. Retention time: $245 \pm 5 \text{ }^\circ\text{C}$ for 2 ± 0.5 seconds
Vibration	Inductance change: Within $\pm 10\%$ Without mechanical damage such as break	1. Vibration frequency: (10 Hz to 55 Hz to 10Hz) in 60 seconds as a period 2. Vibration time: Period cycled for 2 hours in each of 3 mutual perpendicular directions. 3. Amplitude: 1.5 mm max.
Shock	Inductance change: Within $\pm 10\%$ Without mechanical damage such as break	1. Peak value: 100 G 2. Duration of pulse: 11ms 3. 3 times in each positive and negative direction of 3 mutual perpendicular directions
Endurance Reliability		
Item	Specification and Requirement	Test Method
Thermal Shock	Inductance change: Within $\pm 10\%$ Without distinct damage in appearance	1. Repeat 100 cycles as follow: ($-55 \pm 2 \text{ }^\circ\text{C}$; 30 ± 3 min) →(Room temp., 5 min) → ($+125 \pm 2 \text{ }^\circ\text{C}$, 30 ± 3 min) → (Room temp., 5 min) 2. Recovery: $48 + 4 / -0$ hours of recovery under the standard condition after the test.
High Temperature Resistance	Inductance change: Within $\pm 10\%$ Without distinct damage in appearance	1. Environment condition: $85 \pm 2 \text{ }^\circ\text{C}$ Applied Current: Rated current 2. Duration: $1000 + 4 / -0$ hours
Humidity Resistance	Inductance change: Within $\pm 10\%$ Without distinct damage in appearance	1. Environment condition: $60 \pm 2 \text{ }^\circ\text{C}$ Humidity: 90–95% Applied Current: Rated current 2. Duration: $1000 + 4 / -0$ hours
Low Temperature Store	Inductance change: Within $\pm 10\%$ Without distinct damage in appearance	Store temperature: $-55 \pm 2 \text{ }^\circ\text{C}$, $1000 + 4 / -0$ hours
High Temperature Store	Inductance change: Within $\pm 10\%$ Without distinct damage in appearance	Store temperature: $+125 \pm 2 \text{ }^\circ\text{C}$, $1000 + 4 / -0$ hours

Packaging

Series	Tape Width	Reel Diameter	Quantity(pcs)
CMKD-252012A-***M	8mm	180mm	3000
CMKD-0320A-***M	12mm	330mm	3000
CMKD-0410A-***M	12mm	330mm	3000
CMKD-0412A-***M	12mm	330mm	3000
CMKD-0420A-***M	12mm	330mm	3000
CMKD-0518A-***M	12mm	330mm	2000
CMKD-0530A-***M	12mm	330mm	2000
CMKD-0618A-***M	16mm	330mm	1500
CMKD-0624A-***M	16mm	330mm	1500
CMKD-0630A-***M	16mm	330mm	1500
CMKD-0630C-***M	16mm	330mm	1500
CMKD-0630H-***M	16mm	330mm	1500
CMKD-0830A-***M	16mm	330mm	1000
CMKD-1040A-***M	24mm	330mm	500
CMKD-1340A-***M	24mm	330mm	500
CMKD-1350A-***M	24mm	330mm	500
CMKD-1360A-***M	24mm	330mm	500
CMKD-1770A-***M	24mm	330mm	200