

Overview

KEMET's A750 Radial Solid Polymer Aluminum Capacitors offer longer life and greater stability across a wide range of temperatures. This highly conductive solid polymer electrolyte eliminates the risk of drying out and due to its low ESR properties, is able to withstand higher ripple currents during normal operation. This series is ideally suited for industrial and commercial applications. For voltages ≥ 25 V, individual part numbers can be AEC-Q200 qualified on request. See Part Number system to order.

Applications

Typical applications include mobile phone chargers, computer motherboards, servers, and adapters (laptop power supplies). For voltages ≥ 25 V, this series is used for automotive infotainment.

Benefits

- Through-hole form factor
- Low impedance
- High ripple current
- 105°C/2,000 hours
- RoHS compliant
- Halogen-free

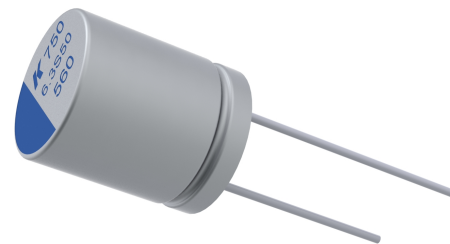

Part Number System

| A | 750 | EK | 567 | M | 0E | AA | E | 020 |
|-----------------|--|---------------------|--|----------------|--|----------------------------|---|---|
| Capacitor Class | Series | Size Code | Capacitance Code (pF) | Tolerance | Rated Voltage (VDC) | Packaging | Electrical Parameters | ESR |
| A = Aluminum | Radial Solid Polymer Aluminum Capacitors 105°C 2,000 hours | See Dimension Table | First two digits represent significant figures for capacitance values. Last digit specifies the number of zeros to be added. | M = $\pm 20\%$ | 2.5 = 0E 4 = 0G 6.3 = 0J 10 = 1A 16 = 1C 25 = 1E 35 = 1V 50 = 1H 63 = 1J | See Ordering Options Table | E = Standard/ESR S = Automotive AEC-Q200 available on ≥ 25 V | Last 3 digits represent significant figures for ESR values. (m Ω) |

Ordering Options Table

| Diameter | Packaging Type | Lead Type | Lead Length (mm) | Lead and Packaging Code |
|---|-------------------|-------------------------------------|---|-------------------------|
| Standard Bulk Packaging Options | | | | |
| 5 - 18 | Bulk (bag) | Long Lead (Loose Standard Leads) | 15 Minimum | AA |
| 5 - 18 | Bulk (bag) | Cut Leads | 5 ⁽¹⁾ | BA |
| 5 - 18 | Bulk (bag) | Formed Leads | 5 ⁽¹⁾ | CA |
| Standard Auto-Insertion Packaging Options | | | | |
| 5 | Ammo Tape and Box | Formed to 2.5 mm | H ₀ = 16±0.5 | FA |
| 5 - 8 | Ammo Tape and Box | Formed to 5 mm | H ₀ = 16±0.5 | DA |
| 6 - 8 | Ammo Tape and Box | Straight | H = 18.5±0.5 (for 8 x 12 H = 20±0.5) | EA |
| 10 - 13 | Ammo Tape and Box | Straight | H = 18.5±0.5 | EA |
| Contact KEMET for other Lead and Packaging options ⁽¹⁾ Contact KEMET for custom Lead Length and options 3 to 10 mm | | | | |

Long Lead (Loose Standard Leads)

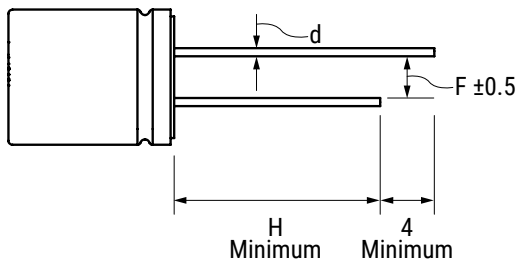

| | Diameter | | | | | |
|---|----------|-----|-----|-----|-----|-----|
| | 5 | 6.3 | 8 | 10 | 13 | 18 |
| d | 0.5 | 0.5 | 0.6 | 0.6 | 0.6 | 0.8 |
| F | 2 | 2.5 | 3.5 | 5 | 5 | 7.5 |
| H | 15 | 15 | 15 | 15 | 15 | 15 |

Cut Lead

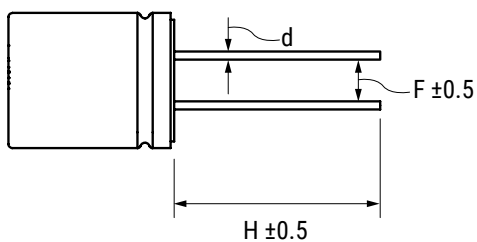

| | Diameter | | | | | |
|---|---|-----|-----|-----|-----|-----|
| | 5 | 6.3 | 8 | 10 | 13 | 18 |
| d | 0.5 | 0.5 | 0.6 | 0.6 | 0.6 | 0.8 |
| F | 2 | 2.5 | 3.5 | 5 | 5 | 7.5 |
| H | According to customer requirement 3 - 10 mm | | | | | |

Formed Lead

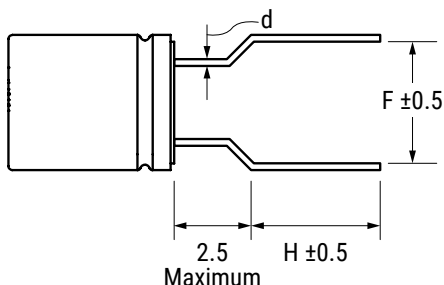

| | Diameter | | | | | |
|---|---|-----|-----|-----|-----|-----|
| | 5 | 6.3 | 8 | 10 | 13 | 18 |
| d | 0.5 | 0.5 | 0.6 | 0.6 | 0.6 | 0.8 |
| F | 5 | 5 | 5 | 5 | 5 | 5 |
| H | According to customer requirement 3 - 10 mm | | | | | |

Dimensions – Millimeters



| Size Code | D | | L | | d | | P | | Safety Vent |
|-----------|---------|-----------|---------|-----------|---------|-----------|---------|-----------|-------------|
| | Nominal | Tolerance | Nominal | Tolerance | Nominal | Tolerance | Nominal | Tolerance | |
| BG | 5 | ±0.5 | 7 | ±1.0 | 0.5 | ±0.05 | 2.0 | ±0.5 | |
| BK | 5 | ±0.5 | 8 | ±1.0 | 0.5 | ±0.05 | 2.0 | ±0.5 | |
| BM | 5 | ±0.5 | 9 | ±1.0 | 0.5 | ±0.05 | 2.0 | ±0.5 | |
| EK | 6.3 | ±0.5 | 8 | ±1.0 | 0.5 | ±0.05 | 2.5 | ±0.5 | |
| EM | 6.3 | ±0.5 | 9 | ±1.0 | 0.5 | ±0.05 | 2.5 | ±0.5 | |
| EQ | 6.3 | ±0.5 | 11 | ±1.0 | 0.5 | ±0.05 | 2.5 | ±0.5 | |
| KK | 8 | ±0.5 | 8 | ±1.0 | 0.6 | ±0.05 | 3.5 | ±0.5 | |
| KR | 8 | ±0.5 | 11.5 | ±1.5 | 0.6 | ±0.05 | 3.5 | ±0.5 | |
| KS | 8 | ±0.5 | 12 | ±1.0 | 0.6 | ±0.05 | 3.5 | ±0.5 | |
| KV | 8 | ±0.5 | 14 | ±2.0 | 0.6 | ±0.05 | 3.5 | ±0.5 | |
| KW | 8 | ±0.5 | 16 | ±2.0 | 0.6 | ±0.05 | 3.5 | ±0.5 | |
| MS | 10 | ±0.5 | 12 | ±1.0 | 0.6 | ±0.05 | 5.0 | ±0.5 | Yes |
| MU | 10 | ±0.5 | 12.5 | ±1.5 | 0.6 | ±0.05 | 5.0 | ±0.5 | Yes |
| MV | 10 | ±0.5 | 14 | ±2.0 | 0.6 | ±0.05 | 5.0 | ±0.5 | Yes |
| MW | 10 | ±0.5 | 16 | ±2.0 | 0.6 | ±0.05 | 5.0 | ±0.5 | Yes |

Performance Characteristics

| Item | Performance Characteristics |
|-----------------------|---|
| Capacitance Range | 47 – 2,200 μ F |
| Rated Voltage | 2.5 – 63 VDC |
| Operating Temperature | -55°C to +105°C |
| Capacitance Tolerance | \pm 20% at 120 Hz/20°C |
| Life Test | 2,000 hours (see conditions in Test Method & Performance) |
| Leakage Current | $I \leq 0.2 CV$ or 280 μ A, whichever is greater C = Rated capacitance (μ F), V = Rated voltage (VDC), Voltage applied for 2 minutes at 20°C. |

Dissipation Factor (tan δ)

| | |
|---------------------------------------|----------|
| Rated Voltage (V) | 2.5 – 63 |
| tan δ (Maximum) at 120 Hz/20°C | 0.12 |

Compensation Factor of Ripple Current (RC) vs. Frequency

| Frequency | 120 Hz $\leq f < 1$ kHz | 1 kHz $\leq f < 10$ kHz | 10 kHz $\leq f < 100$ kHz | 100 kHz $\leq f < 500$ kHz |
|-------------|-------------------------|-------------------------|---------------------------|----------------------------|
| Coefficient | 0.05 | 0.30 | 0.70 | 1.00 |

Test Method & Performance

| Conditions | Load Life Test | Shelf Life Test |
|---|---|---------------------------|
| Temperature | 105°C | 105°C |
| Test Duration | 2,000 hours | 96 hours |
| Ripple Current | No ripple current applied | No ripple current applied |
| Voltage | The sum of DC voltage and the peak AC voltage must not exceed the rated voltage of the capacitor | No voltage applied |
| Performance | The following specifications will be satisfied when the capacitor is restored to 20°C. | |
| Capacitance Change | Within ±20% of the initial value | |
| Dissipation Factor | Does not exceed 150% of the specified value | |
| ESR | Does not exceed 150% of the specified value | |
| Leakage Current | Does not exceed specified value | |
| Damp Heat | The following specifications will be satisfied when the capacitor is restored to 20°C after application of rated voltage for 1,000 hours at 60°C, 90%~95% RH. | |
| Capacitance Change | Within ±20% of the initial value | |
| Dissipation Factor | Does not exceed 150% of the specified value | |
| ESR | Does not exceed 150% of the specified value | |
| Leakage Current | Does not exceed specified value | |
| Surge Voltage (Rated Voltage x 1.15 (V)) | The following specifications will be satisfied when the capacitor is subjected to 1,000 cycles each consisting of charge with the surge voltages specified at 105°C for 30 seconds through a protective resistor (Rc = 1 kΩ) and discharge for 5 minutes 30 seconds. | |
| Capacitance Change | Within ±20% of the initial value | |
| Dissipation Factor | Does not exceed 150% of the specified value | |
| ESR | Does not exceed 150% of the specified value | |
| Leakage Current | Does not exceed specified value | |

Shelf Life and Re-Ageing

Shelf Life

Solderability is 12 months

The capacitance, ESR and impedance of a capacitor will not change significantly after extended storage periods, however the leakage current will slowly increase.

- This series should not be stored in high temperatures or where there is a high level of humidity.
- The suitable storage condition is +5 to +35°C and less than 75% in relative humidity.
- Do not store in damp conditions such as water, saltwater spray or oil spray.
- Do not store in an environment full of hazardous gas (hydrogen sulphide, sulphurous acid gas, nitrous acid, chlorine gas, ammonium, etc.)
- Do not store under exposure to ozone, ultraviolet rays or radiation.

If a capacitor has been stored for more than 24 months under these conditions and it shows increased leakage current, then a treatment by voltage application is recommended.

Re-age Procedure

Apply the rated DC voltage to the capacitor at 105°C for a period of 120 minutes through a 1 kΩ series resistor.

Environmental Compliance

As an environmentally conscious company, KEMET is working continuously with improvements concerning the environmental effects of both our capacitors and their production. In Europe (RoHS Directive) and in some other geographical areas like China, legislation has been put in place to prevent the use of some hazardous materials, such as lead (Pb), in electronic equipment. All products in this catalog are produced to help our customers' obligations to guarantee their products and fulfill these legislative requirements. The only material of concern in our products has been lead (Pb), which has been removed from all designs to fulfill the requirement of containing less than 0.1% of lead in any homogeneous material. KEMET will closely follow any changes in legislation worldwide and makes any necessary changes in its products, whenever needed.

Some customer segments such as medical, military and automotive electronics may still require the use of Lead in electrode coatings. To clarify the situation and distinguish products from each other, a special symbol is used on the packaging labels for RoHS compatible capacitors.

Due to customer requirements, there may appear additional markings such as LF = Lead-free, or LFW = Lead-free wires on the label.

Table 1 – Ratings & Part Number Reference

| VDC | VDC Surge Voltage | Rated Capacitance 120 Hz 20°C (µF) | Case Size D x L (mm) | ESR 100 kHz 20°C (mΩ) | RC 100 Hz 105°C (mA) | LC 20°C 2 minutes (µA) | KEMET Part Number |
|-----|-------------------|---------------------------------------|-------------------------|-----------------------------|-------------------------------|------------------------------|----------------------|
| 2.5 | 2.9 | 330 | 6.3 x 8 | 7 | 5,600 | 500 | A750EK337M0E(1)E007 |
| 2.5 | 2.9 | 470 | 6.3 x 8 | 7 | 5,600 | 500 | A750EK477M0E(1)E007 |
| 2.5 | 2.9 | 560 | 6.3 x 8 | 20 | 2,690 | 280 | A750EK567M0E(1)E020 |
| 2.5 | 2.9 | 820 | 6.3 x 8 | 7 | 5,600 | 500 | A750EK827M0E(1)E007 |
| 2.5 | 2.9 | 1,000 | 8 x 8 | 12 | 5,700 | 500 | A750KK108M0E(1)E012 |
| 2.5 | 2.9 | 1500 | 8 x 11.5 | 7 | 6,100 | 750 | A750KR158M0E(1)E007 |
| 4 | 4.6 | 560 | 6.3 x 8 | 18 | 3,100 | 448 | A750EK567M0G(1)E018 |
| 4 | 4.6 | 680 | 8 x 11.5 | 7 | 6,100 | 544 | A750KR687M0G(1)E007 |
| 4 | 4.6 | 820 | 8 x 11.5 | 7 | 6,100 | 656 | A750KR827M0G(1)E007 |
| 4 | 4.6 | 1000 | 8 x 11.5 | 7 | 6,100 | 800 | A750KR108M0G(1)E007 |
| 4 | 4.6 | 1200 | 8 x 11.5 | 7 | 6,100 | 960 | A750KR128M0G(1)E007 |
| 4 | 4.6 | 1800 | 10 x 12.5 | 7 | 6,100 | 1,440 | A750MU188M0G(1)E007 |
| 4 | 4.6 | 2200 | 10 x 12.5 | 7 | 6,100 | 1,760 | A750MU228M0G(1)E007 |
| 6.3 | 7.2 | 220 | 5 x 7 | 20 | 2,500 | 280 | A750BG227M0J(1)E020 |
| 6.3 | 7.2 | 270 | 5 x 8 | 11 | 3,700 | 340 | A750BK277M0J(1)E011 |
| 6.3 | 7.2 | 270 | 5 x 7 | 20 | 3,100 | 340 | A750BG277M0J(1)E020 |
| 6.3 | 7.2 | 330 | 5 x 8 | 11 | 3,700 | 416 | A750BK337M0J(1)E011 |
| 6.3 | 7.2 | 330 | 5 x 7 | 20 | 3,100 | 416 | A750BG337M0J(1)E020 |
| 6.3 | 7.2 | 390 | 5 x 8 | 11 | 3,700 | 491 | A750BK397M0J(1)E011 |
| 6.3 | 7.2 | 390 | 5 x 9 | 20 | 3,100 | 491 | A750BM397M0J(1)E020 |
| 6.3 | 7.2 | 470 | 6.3 x 8 | 18 | 3,100 | 592 | A750EK477M0J(1)E018 |
| 6.3 | 7.2 | 560 | 6.3 x 8 | 18 | 3,100 | 706 | A750EK567M0J(1)E018 |
| 6.3 | 7.2 | 680 | 6.3 x 8 | 8 | 5,000 | 857 | A750EK687M0J(1)E008 |
| 6.3 | 7.2 | 680 | 8 x 8 | 16 | 4,100 | 857 | A750KK687M0J(1)E016 |
| 6.3 | 7.2 | 820 | 6.3 x 9 | 8 | 5,000 | 1,033 | A750EM827M0J(1)E008 |
| 6.3 | 7.2 | 820 | 8 x 8 | 16 | 4,100 | 1,033 | A750KK827M0J(1)E016 |
| 6.3 | 7.2 | 1,000 | 8 x 8 | 15 | 4,100 | 1,260 | A750KK108M0J(1)E015 |
| 6.3 | 7.2 | 1,200 | 8 x 12 | 14 | 4,100 | 1,512 | A750KS128M0J(1)E014 |
| 6.3 | 7.2 | 1,500 | 8 x 12 | 14 | 4,100 | 1,890 | A750KS158M0J(1)E014 |
| 10 | 11.5 | 100 | 5 x 8 | 24 | 2,490 | 200 | A750BK107M1A(1)E024 |
| 10 | 11.5 | 120 | 5 x 8 | 24 | 2,490 | 240 | A750BK127M1A(1)E024 |
| 10 | 11.5 | 220 | 6.3 x 8 | 18 | 3,100 | 440 | A750EK227M1A(1)E018 |
| 10 | 11.5 | 270 | 6.3 x 8 | 10 | 4,680 | 540 | A750EK277M1A(1)E010 |
| 10 | 11.5 | 330 | 6.3 x 8 | 16 | 4,100 | 660 | A750EK337M1A(1)E016 |
| 10 | 11.5 | 470 | 6.3 x 9 | 12 | 4,100 | 940 | A750EM477M1A(1)E012 |
| 10 | 11.5 | 470 | 8 x 8 | 16 | 4,100 | 940 | A750KK477M1A(1)E016 |
| 10 | 11.5 | 560 | 6.3 x 11 | 12 | 4,100 | 1,120 | A750EQ567M1A(1)E012 |
| 10 | 11.5 | 560 | 8 x 8 | 16 | 4,100 | 1,120 | A750KK567M1A(1)E016 |
| 10 | 11.5 | 680 | 6.3 x 11 | 15 | 3,600 | 1,360 | A750EQ687M1A(1)E015 |
| 10 | 11.5 | 680 | 8 x 12 | 14 | 4,100 | 1,360 | A750KS687M1A(1)E014 |
| 10 | 11.5 | 820 | 8 x 12 | 14 | 4,100 | 1,640 | A750KS827M1A(1)E014 |
| 10 | 11.5 | 1,000 | 10 x 12 | 13 | 4,500 | 2,000 | A750MS108M1A(1)E013 |
| VDC | VDC Surge | Rated Capacitance | Case Size | ESR | RC | LC | Part Number |

(1)Please see packaging codes for options.

(2)Electrical Parameters code. See Part Number System for available options

Table 1 – Ratings & Part Number Reference cont.

| VDC | VDC Surge Voltage | Rated Capacitance 120 Hz 20°C (µF) | Case Size D x L (mm) | ESR 100 kHz 20°C (mΩ) | RC 100 Hz 105°C (mA) | LC 20°C 2 minutes (µA) | KEMET Part Number |
|-----|-------------------|---------------------------------------|-------------------------|-----------------------------|-------------------------------|------------------------------|-----------------------|
| 16 | 18.4 | 100 | 6.3 x 8 | 18 | 2,900 | 320 | A750EK107M1C(1)E018 |
| 16 | 18.4 | 220 | 6.3 x 8 | 16 | 2,900 | 704 | A750EK227M1C(1)E016 |
| 16 | 18.4 | 270 | 6.3 x 9 | 15 | 3,600 | 864 | A750EM277M1C(1)E015 |
| 16 | 18.4 | 330 | 6.3 x 9 | 15 | 3,600 | 1,056 | A750EM337M1C(1)E015 |
| 16 | 18.4 | 330 | 8 x 8 | 14 | 5,000 | 1,056 | A750KK337M1C(1)E014 |
| 16 | 18.4 | 390 | 6.3 x 11 | 15 | 3,600 | 1,248 | A750EQ397M1C(1)E015 |
| 16 | 18.4 | 470 | 6.3 x 11 | 15 | 3,600 | 1,504 | A750EQ477M1C(1)E015 |
| 16 | 18.4 | 470 | 8 x 12 | 13 | 4,100 | 1,504 | A750KS477M1C(1)E013 |
| 16 | 18.4 | 560 | 8 x 12 | 13 | 4,800 | 1,792 | A750KS567M1C(1)E013 |
| 16 | 18.4 | 820 | 10 x 12 | 13 | 4,800 | 2,624 | A750MS827M1C(1)E013 |
| 16 | 18.4 | 1,000 | 10 x 12 | 13 | 5,250 | 3,200 | A750MS108M1C(1)E013 |
| 16 | 18.4 | 1200 | 10 x 14 | 12 | 6,100 | 3,840 | A750MV128M1C(1)E012 |
| 16 | 18.4 | 1500 | 10 x 14 | 10 | 6,100 | 4,800 | A750MV158M1C(1)E010 |
| 16 | 18.4 | 1800 | 10 x 16 | 10 | 7,000 | 5,760 | A750MW188M1C(1)E010 |
| 16 | 18.4 | 2200 | 10 x 16 | 10 | 7,000 | 7,040 | A750MW228M1C(1)E010 |
| 25 | 28.8 | 47 | 6.3 x 8 | 40 | 2,900 | 280 | A750EK476M1E(1)(2)040 |
| 25 | 28.8 | 100 | 8 x 8 | 40 | 4,500 | 500 | A750KK107M1E(1)(2)040 |
| 25 | 28.8 | 220 | 8 x 12 | 15 | 4,420 | 1,100 | A750KS227M1E(1)(2)015 |
| 25 | 28.8 | 330 | 8 x 12 | 18 | 3,500 | 1,650 | A750KS337M1E(1)(2)018 |
| 25 | 28.8 | 470 | 10 x 12 | 15 | 4,900 | 2,350 | A750MS477M1E(1)(2)015 |
| 25 | 28.8 | 560 | 10 x 12 | 15 | 4,900 | 2,800 | A750MS567M1E(1)(2)015 |
| 25 | 28.8 | 680 | 8 x 16 | 16 | 4,650 | 3,400 | A750KW687M1E(1)(2)016 |
| 25 | 28.8 | 820 | 10 x 14 | 14 | 5,100 | 4,100 | A750MV827M1E(1)(2)014 |
| 25 | 28.8 | 1000 | 10 x 14 | 14 | 5,100 | 5,000 | A750MV108M1E(1)(2)014 |
| 25 | 28.8 | 1200 | 10 x 16 | 14 | 5,910 | 6,000 | A750MW128M1E(1)(2)014 |
| 35 | 40.3 | 270 | 8 x 14 | 20 | 4,000 | 1,890 | A750KV277M1V(1)(2)020 |
| 35 | 40.3 | 330 | 8 x 16 | 20 | 4,100 | 2,310 | A750KW337M1V(1)(2)020 |
| 35 | 40.3 | 390 | 10 x 14 | 20 | 4,300 | 2,730 | A750MV397M1V(1)(2)020 |
| 35 | 40.3 | 470 | 10 x 14 | 18 | 4,500 | 3,290 | A750MV477M1V(1)(2)018 |
| 35 | 40.3 | 560 | 10 x 16 | 18 | 4,690 | 3,920 | A750MW567M1V(1)(2)018 |
| 35 | 40.3 | 680 | 10 x 16 | 18 | 4,690 | 4,760 | A750MW687M1V(1)(2)018 |
| 50 | 57.5 | 180 | 10 x 14 | 22 | 4,100 | 1,800 | A750MV187M1H(1)(2)022 |
| 50 | 57.5 | 220 | 10 x 14 | 20 | 4,300 | 2,200 | A750MV227M1H(1)(2)020 |
| 50 | 57.5 | 270 | 10 x 14 | 18 | 4,500 | 2,700 | A750MV277M1H(1)(2)018 |
| 50 | 57.5 | 330 | 10 x 16 | 20 | 4,950 | 3,300 | A750MW337M1H(1)(2)020 |
| 63 | 72.5 | 150 | 10 x 14 | 22 | 4,100 | 1,890 | A750MV157M1J(1)(2)022 |
| 63 | 72.5 | 180 | 10 x 16 | 20 | 4,950 | 2,268 | A750MW187M1J(1)(2)020 |
| VDC | VDC Surge | Rated Capacitance | Case Size | ESR | RC | LC | Part Number |

(1)Please see packaging codes for options.

(2)Electrical Parameters code. See Part Number System for available options

Installing

Solid Polymer Aluminum Capacitors are prone to a change in leakage current due to thermal stress during soldering. The leakage current may increase after soldering or reflow soldering. Therefore, verify the suitability for use in circuits sensitive to leakage current.

A general principle is that lower temperature operation results in a longer, useful life of the capacitor. For this reason, it should be ensured that electrolytic capacitors are placed away from heat-emitting components. Adequate space should be allowed between components for cooling air to circulate, especially when high ripple current loads are applied. In any case, the maximum rated temperature must not be exceeded.

- Do not deform the case of capacitors or use capacitors with a deformed case.
- Verify that the connections of the capacitors are able to insert on the board without excessive mechanical force. Excessive force during insertion, as well as after soldering may cause terminal damage and affect the electrical performance.
- Ensure electrical insulation between the capacitor case, negative terminal, positive terminal and PCB.
- If the capacitors require mounting through additional means, the recommended mounting accessories shall be used.
- Verify the correct polarization of the capacitor on the board.

KEMET recommends, to ensure that the voltage across each capacitor does not exceed its rated voltage.

Temperature Stability Characteristics

Stable characteristics in a very low temperature range allows for less circuits in the design.

Due to a solid polymer electrolyte, Solid Polymer Aluminum Capacitors feature higher conductivity. This results in a lower ESR which, coupled with high capacitance allows an aluminum polymer capacitor to replace several standard electrolytic capacitors, reducing the number of components and maximizing board space.

The ESR of polymer capacitors is nearly constant within its operating temperature range, while the ESR of a standard electrolytic capacitor noticeably changes with temperature.

Temperature Stability Characteristics

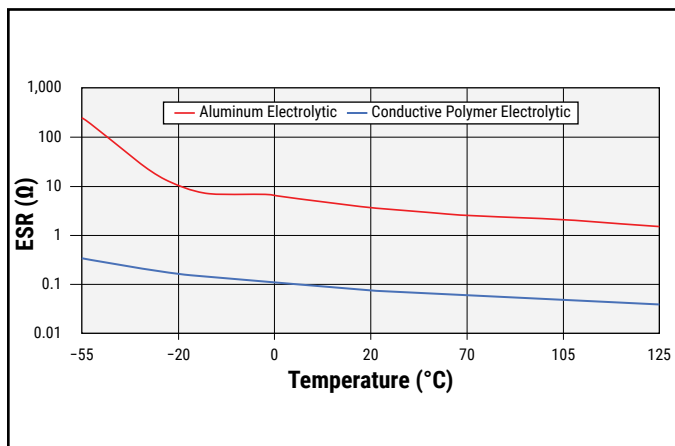

Expected Life Calculation Chart

Expected life depends on operating temperature according to the following formula:

$$L = L_0 \times 10^{(T_0 - T) / 20}$$

Where:

L: Expected life

L₀: Life at maximum permissible operating temperature with rated operating voltage applied (hours)

T: Actual operating temperature

T₀: Maximum permissible operating temperature

Expected Life Calculation Chart

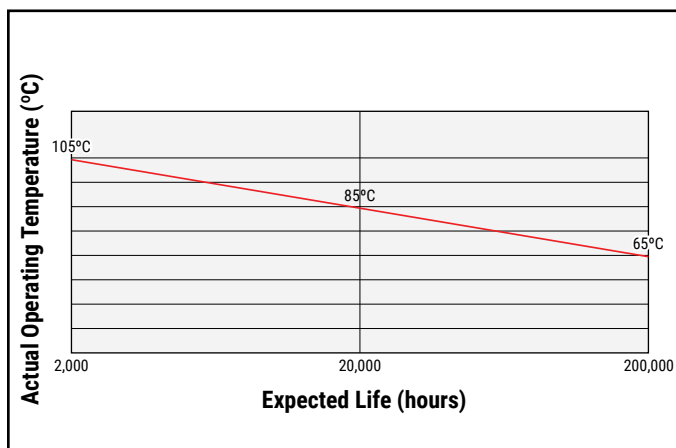

The effect of derating temperature can be seen in this graph.

In this example, the life expectancy of a 2,000 hour Polymer capacitor is significantly greater than that of a 2,000 hour standard electrolytic capacitor.

Capacitor Life (H)

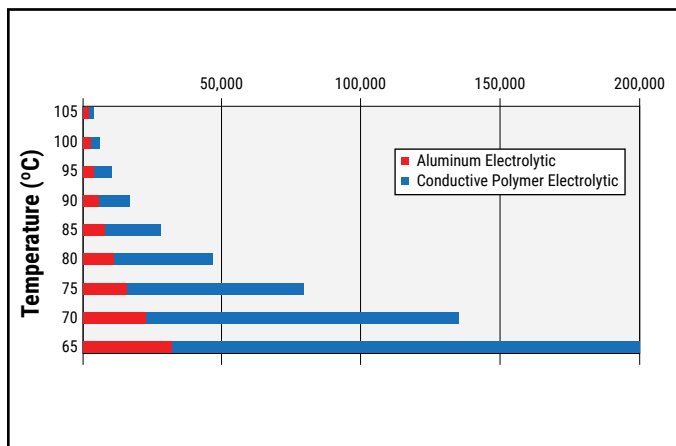

Stability of ESR across Frequency Range

Due to a solid polymer electrolyte, the ESR curve of a solid polymer aluminum capacitor, is lower and more stable than that of a standard electrolytic capacitor.

Stable ESR Values across Frequency

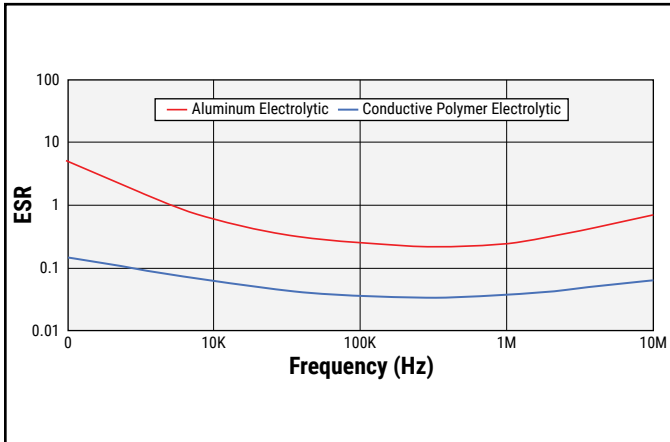

High Resistance to Ripple Current

As a result of a lower ESR, solid polymer aluminum capacitors are able to withstand higher ripple currents during normal operation.

Allowable Ripple Current (100 kHz 105°C)

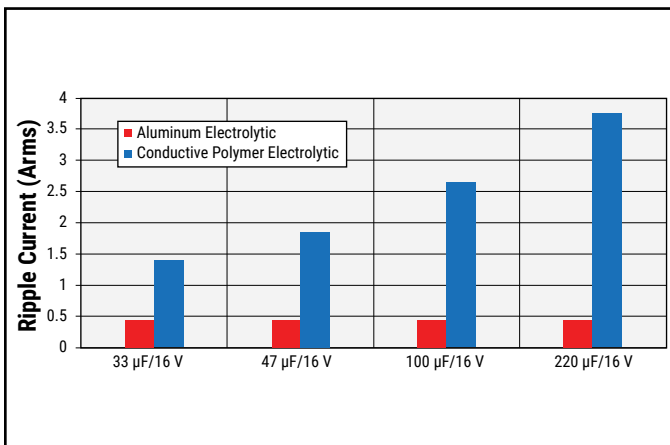

Marking

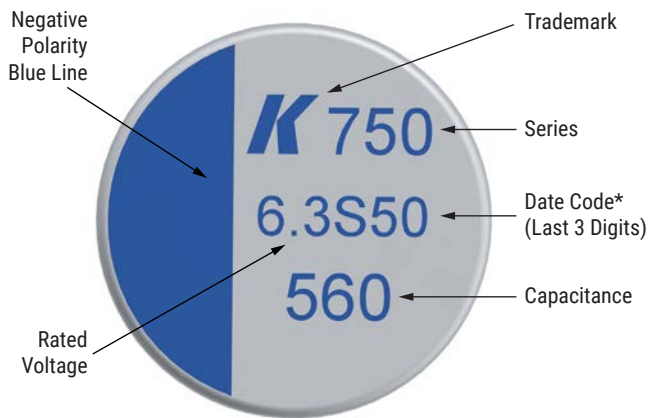

| Date Code* | |
|--|--|
| 1 st Digits = Rated Voltage | |
| Letter = Year Code | S = 2019 |
| Final Digits = Week of the Year | 01 = 1 st week of the Year to 52 = 52 nd week of the Year |
| Year Code | |
| S | 2019 |
| T | 2020 |
| U | 2021 |
| V | 2022 |
| W | 2023 |
| X | 2024 |
| Y | 2025 |
| Z | 2026 |

Construction

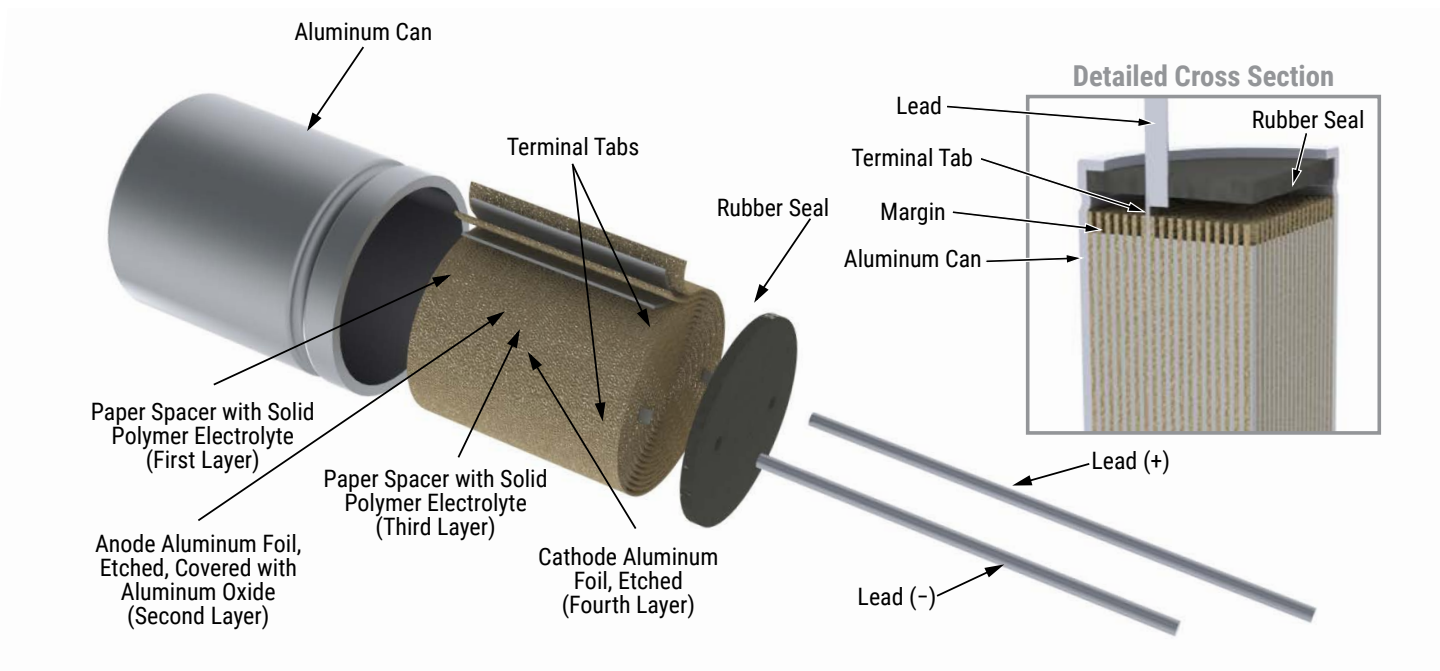

Flow Soldering (not suitable for SMD parts)

The soldering conditions should be within the specified conditions below:

- Do not dip the capacitors body into the melted solder.
- Flux should only be applied to the capacitors terminals.
- Vapour heat transfer systems are not recommended. The system should be thermal, such as infra-red radiation or hot blast.
- Observe the soldering conditions as shown below.
- Do not exceed these limits and avoid repeated reflowing.

Flow Soldering

| | Temperature (°C) | Maximum Time (Seconds) | Maximum Repetitions |
|----------|------------------|------------------------|---------------------|
| Pre-heat | < 120 | < 120 | 1 |
| Solder | 260±5°C | < 10 | 2 |

Taping for Automatic Insertion Machines

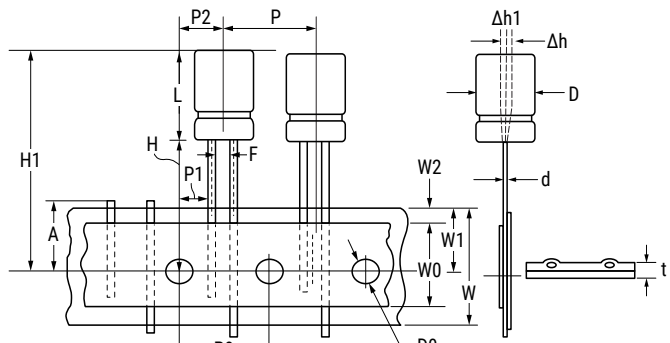
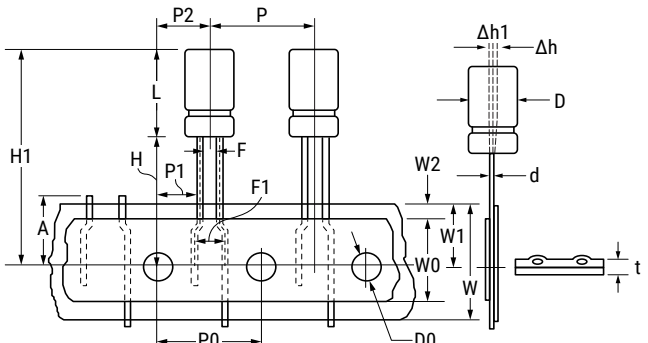
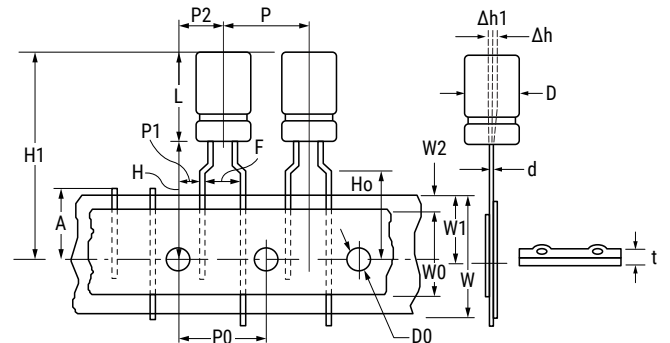
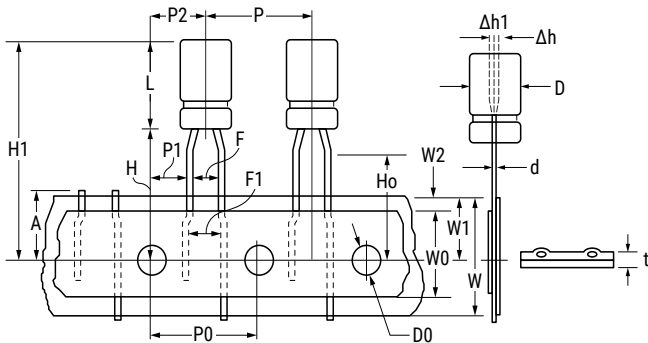

| Dimensions (mm) | D | L | d | P | P0 | P1 | P2 | F | W | W0 | W1 | W2 | H | Ho | D0 | A | H1 | Δh | Δh1 | t | |
|------------------------------|------|-------------|-------|------|------|------|------|------|------|------|------|-----|-------|------|------|------|------|----|-----|------|------|
| Tolerance | ±0.5 | | ±0.02 | ±1.0 | ±0.2 | ±0.7 | ±1.0 | ±0.5 | ±0.5 | min | ±0.5 | max | ±0.75 | ±0.5 | ±0.2 | Max. | Max. | ±2 | ±1 | ±0.3 | |
| Formed to 2.5 mm | 5 | 7.0 9-11 | 0.5 | 12.7 | 12.7 | 5.1 | 6.35 | 2.5 | 18 | 12.5 | 9 | 1.5 | 17.5 | 16 | | | | | | | |
| Formed to 5 mm | 5 | 7-11 | 0.5 | 12.7 | 12.7 | 3.85 | 6.35 | 5 | 18 | 12.5 | 9 | 1.5 | 18.5 | 16 | | | 32.5 | | | | |
| | 6.3 | 8-11 | | | | | | | | | | | | | | | | | | | |
| | 8 | 8.0 12.0 | 0.6 | | | | | | | | | | | | | | | | | | |
| | 6.3 | 8-11 | 0.5 | 12.7 | 12.7 | 5.4 | 6.35 | 2.5 | 18 | 12.5 | 9 | 1.5 | 18.5 | 16 | 4 | 11 | | 0 | 0 | 0.7 | |
| Straight leads 6 – 8 mm | 8 | 8.0 12.0 | 0.6 | | | | | 3.5 | | | | | 20 | | | | | | | | |
| | | | | | | | | | | | | | | | | | | | | | |
| Straight leads 10 – 13 mm | 10 | 12 | 0.6 | 12.7 | 12.7 | 3.85 | 6.35 | 5 | 18 | 12.5 | 9 | 1.5 | 18.5 | | | | | | | | 33 |
| | | 16.0 | | | | | | | | | | | | | | | | | | | 36 |
| | | 18.0 | | | | | | | | | | | | | | | | | | | 41 |
| | | 20.0 | | | | | | | | | | | | | | | | | | | 40.5 |
| | 13 | 20.0 | | 15 | 15 | 5 | 7.5 | | | | | | | | | | | | | | |

Construction Data

The manufacturing process begins with the anode foil being electrochemically etched to increase the surface area and then 'formed' to produce the aluminum oxide layer. Both the anode and cathode foils are then interleaved with absorbent paper and wound into a cylinder. During the winding process, aluminum tabs are attached to each foil to provide the electrical contact.

The deck, complete with terminals, is attached to the tabs and then folded down to rest on top of the winding. The complete winding is impregnated with a conductive polymer electrolyte before being housed in a suitable container, usually an aluminum can, and sealed. Throughout the process, all materials inside the housing must be maintained at the highest purity and be compatible with the electrolyte.

Each capacitor is aged and tested before being packed. The purpose of aging is to repair any damage in the oxide layer and thus reduce the leakage current to a very low level. Aging is normally carried out at the rated temperature of the capacitor and is accomplished by applying voltage to the device while carefully controlling the supply current. The process may take several hours to complete. Damage to the oxide layer can occur due to variety of reasons:

- Slitting of the anode foil after forming
- Attaching the tabs to the anode foil
- Minor mechanical damage caused during winding

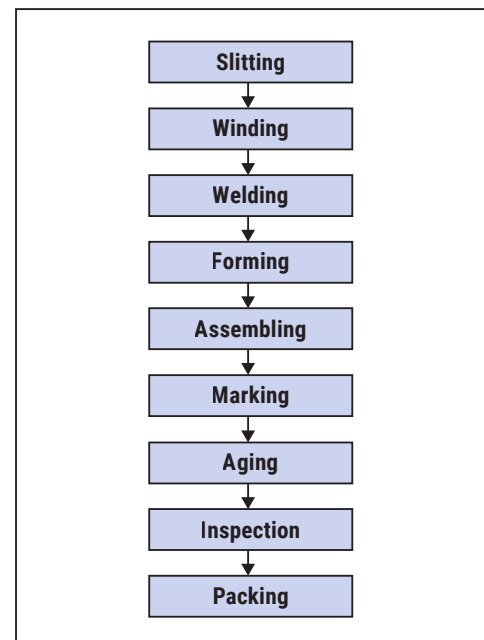
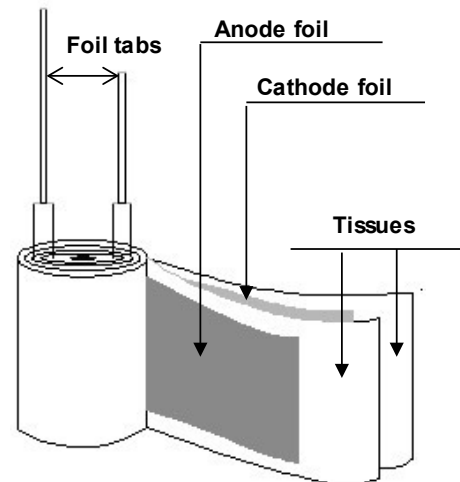

Product Safety

THESE NOTES SHOULD BE READ IN CONJUNCTION WITH THE PRODUCT DATA SHEET. FAILURE TO OBSERVE THE RATINGS AND THE INFORMATION ON THIS SHEET MAY RESULT IN A SAFETY HAZARD.

Warning

When potential lethal voltages e.g. 30 VAC (RMS) or 60 VDC are applied to the terminals of this product, the use of a hazard warning label is recommended.

1. Electrolyte

Conductive polymer aluminum solid electrolytic capacitors contain polymers (electrolytes) which can be hazardous.

1.1 Safety Precautions

In the event of gas venting, avoid contact and inhalation. Wash the affected area with hot water. Use rubber gloves to avoid skin contact. Any contact with the eyes should be liberally irrigated with water and medical advice sought.

2. Intrinsic Properties

2.1 Operating

DC capacitors are polar devices and will operate safely only if correctly connected. Reversing the connections will result in high leakage currents which could subsequently cause short circuit failure and possibly explosion and fire. Correctly polarized operation may result in the above failure modes if:

- The surge voltage is exceeded
- The ambient temperature is too high
- Excessive ripple currents are applied

2.2 Non-Operating

Excessive torque or soldering heat may affect the performance of the capacitor or damage the sealing. Electric shock may result if capacitors are not discharged.

3. Disposal

Aluminum electrolytic capacitors are consignable waste under the Special Waste Regulations 1996 (Statutory Instrument 1996 No 972), which complies with the EC Hazardous Waste Directive – Directive 91/689/EEC. The electrolyte should therefore be treated as a hazardous waste and advice should be sought from the local office of the Environmental Agency regarding its disposal.

Due to the construction of an aluminum electrolytic capacitors, high temperature incineration may cause the component to explode due to build-up of internal pressure. In addition, incineration may also cause the emission of noxious fumes. KEMET strongly recommends that if there are any doubts regarding the disposal of conductive polymer aluminum solid electrolytic capacitors, that advice be sought from the local regulating authority.

In addition, KEMET would like to request that users of aluminum electrolytic capacitors respect the needs of the environment and, wherever possible, recover as much of the materials as possible, i.e. aluminum.

Product Safety cont.

4. Unsafe Use

Most failures are of a passive nature and do not represent a safety hazard. A hazard may, however, arise if this failure causes a dangerous malfunction of the equipment in which the capacitor is employed. Circuits should be designed to fail safe under the normal modes of failure.

The usual failure mode is an increase in leakage current or short circuit. Other possible modes are decrease of capacitance, increase in dissipation factor (and impedance) or an open circuit. Capacitors should be used in a well-ventilated enclosure or cabinet.

5. Mounting

Care should be taken when mounting by clamp, that any safety vent in the can is not covered.

6. Fumigation

In many countries throughout the world it is now common practice to fumigate shipments of products in order to control insect infestation, particularly when wooden packaging is used. Currently, methyl bromide is widely used as a fumigant, which can penetrate cardboard packing and polymer bags and, therefore, come into direct contact with equipment or components contained within.

If aluminum electrolytic capacitors become exposed to methyl bromide then corrosion may occur, depending upon the concentration and exposure time to the chemical.

This failure mode can affect all types of KEMET aluminum electrolytic capacitors. Methyl bromide can penetrate the seals of aluminum electrolytic capacitors and cause internal corrosion of the anode connection, resulting in the component becoming open circuit. The rate of corrosion will depend upon the level of exposure to methyl bromide as well as the subsequent operating conditions, such as voltage and temperature. It may take months or, in some cases, several years before the component becomes open circuit.

7. Dielectric Absorption

A phenomenon known as dielectric absorption can cause aluminum electrolytic capacitors to recharge themselves. The phenomenon is well known but impossible to predict with any great accuracy, so potentially any electrolytic product could be affected. Thus, a capacitor that has been charged and then completely discharged will appear to recharge itself if left open circuit; this will manifest itself as a small voltage across the terminals of the capacitor. Generally, the voltages seen are less than 20 VDC. However, higher voltages have on occasion been reported.

In order to avoid any problems caused by this voltage, KEMET recommends that capacitors be discharged before connecting to the terminals.

KEMET Electronics Corporation Sales Offices

For a complete list of our global sales offices, please visit www.kemet.com/sales.

Disclaimer

All product specifications, statements, information and data (collectively, the "Information") in this datasheet are subject to change. The customer is responsible for checking and verifying the extent to which the Information contained in this publication is applicable to an order at the time the order is placed. All Information given herein is believed to be accurate and reliable, but it is presented without guarantee, warranty, or responsibility of any kind, expressed or implied.

Statements of suitability for certain applications are based on KEMET Electronics Corporation's ("KEMET") knowledge of typical operating conditions for such applications, but are not intended to constitute – and KEMET specifically disclaims – any warranty concerning suitability for a specific customer application or use. The Information is intended for use only by customers who have the requisite experience and capability to determine the correct products for their application. Any technical advice inferred from this Information or otherwise provided by KEMET with reference to the use of KEMET's products is given gratis, and KEMET assumes no obligation or liability for the advice given or results obtained.

Although KEMET designs and manufactures its products to the most stringent quality and safety standards, given the current state of the art, isolated component failures may still occur. Accordingly, customer applications which require a high degree of reliability or safety should employ suitable designs or other safeguards (such as installation of protective circuitry or redundancies) in order to ensure that the failure of an electrical component does not result in a risk of personal injury or property damage.

Although all product-related warnings, cautions and notes must be observed, the customer should not assume that all safety measures are indicated or that other measures may not be required.

KEMET is a registered trademark of KEMET Electronics Corporation.