

承 认 书

SPECIFICATION FOR APPROVAL

客 户
CUSTOMER NAME :

项 目 TYPE:PHB (PHB)
DESCRIPTION : METALLIZED POLYPROPYLENE FILM
INTERFERENCE SUPPRESSION CAPACITOR

客 户 料 号 金属化聚丙烯膜抗干扰电容器
CUSTOMER' S P/N :

鸿 志 料 号
HEL' S P/N : PHB473J2JA8A50R0

※This specification will be invalidated assuming that it is not accepted when it is not returned with one year from the date of issue

CUSTOMER		HEL	
APPROVAL	PREPARE	APPROVAL	PREPARE
		隗红	林意杰

HEL

HONG ZHI ENTERPRISE CO

ADD: No.6, Pujiang Road, Shantou, Guangdong

TEL: 0754-88788046 FAX: 0754-88784178

1.SAFETY APPROVAL STANDARDS

Specification	Subject	File No
CQC(GB/T 14472-1998)	Interference suppression capacitor	CQC07001018754
UL(UL1414)	Across the line ,Antenna coupling and line by pass capacitor	E192572
CSA (CSA C22.2 NO-104)	Across the line,Audio and Video equipment	2273014
VDE(IEC60384-14-III EN132400)	Fixed capacitor for electromagnetic interference suppression and connection to the supply mains	40023936
ENEC(IEC60384-14-III EN132400)	Fixed capacitor for electromagnetic interference suppression and connection to the supply mains	NO2154

2.NUMBER DECODE REGULATION

PHB 473 J 2J A8 A5 0 R 0 0
 ① ② ③ ④ ⑤ ⑥ ⑦ ⑧ ⑨ ⑩

1. SERIES

PEI	PES	PEN	MPE	MES	MEM	MMB	MEB	MET	MEF	PPL	PPN	PPT	MPP	MPB	MPT	MPF
MPS	MSB	PST	PSC	PPS	PSM	PSB	PSH	PHB	MPX	MX1	MPY	SKC	PSA	PSR	PCC	PAC

2. RATED CAPACITANCE

CODE	101	102	103	104	105	106
PF	100PF	1000PF	10000PF	100000PF	1000000PF	10µF
NF		1 NF	10 NF	100 NF	1000 NF	
µF		0.001µF	0.01µF	0.1µF	1.0µF	

3. TOLERANCE

Tolerance	±1%	±2%	±2.5%	±3%	±5%	±10%	±20%
Symbols	F	G	H	I	J	K	M

4. RATED VOLTAGE

	A	B	C	D	E	F	G	H	I	J	K	L
0	1.0	1.25	1.6	2.0	2.5	3.15	4.0	5.0		6.3	8.0	
1	10	12.5	16	20	25	31.5	40	50		63	80	
2	100	125	160	200	250	315	400	500		630	800	
3	1000	1250	1600	2000	2500	3150	4000	5000		6300	8000	
4	10000	12500	16000	20000	25000	31500	40000	50000		63000	80000	
7	175V AC	275V AC	305V AC									

5. WIDTH OR DIAMETED mm

	0	1	2	3	4	5	6	7	8	9
-		1	2.5	3	4	5	6	7.5	8	9
A	10	11	12.5	13	14	15	16	17.5	18	19
B	20	21	22.5	23	24	25	26	27.5	28	29
C	30	31	32.5	33	34	35	36	37.5	38	39
D	40	41	42.5	43	44	45	46	47.5	48	49
E	50	51	52.5	53	54	55	56	57.5	58	59

A1=11mm, -1=1mm, -2=2.5mm, -7=7.5mm B3=23mm

3. SPECIFICATIONS:

1. OPERATING TEMPERATURE: -40°C~+105°C
2. CAPACITANCE RANGE: 0.01μF~2.2μF
3. CAPACITANCE TOLERANCE: ±5%(J), ±10%(K), ±20%(M)
4. RATED VOLTAGE: 250VAC~, 275VAC
5. DISSIPATION FACTOR: 0.1% MAX AT 1KHZ, 25°C
6. INSULATION RESISTANCE: >35000 MΩ(C≤0.33μF); 1000 MΩ·μF (C>0.33μF)
7. MAX. Pulse rise time (dv/dt) :

V _R (ac)	Lead spacing				
	10mm	15mm	22.5mm	27.5mm	37.5
275VAC	500	400	200	140	100

4. PERFORMANCE

Test Characteristics	GB/T 14472 (IEC 60384-14)	Performance
Withstand voltage: Between terminals (4.31kr)	For 1800VDC 2 sec.	Shall be no abnormality
Withstand voltage: Between terminals & enclosure	For 2.0U _R +1500VAC 2 sec	Shall be no abnormality
Insulation resistance: Between terminals	Apply rated voltage ±15% for 60 sec. When rated voltage under 100V. Apply 100V ±15% when rated voltage from 100V to 500V at 20°C	≥ 30,000MΩ
Insulation resistance: Between terminals & enclosure		≥ 30,000MΩ
Heat proof: Insulation resistance at 85°C	Testing temperature: 85±2°C.	±5% Within ~2% of the value before test
Heat proof: Rate of variation of capacitance at 85°C		No permanent breakdown or flashover
Impulse voltage	According to fig.1, before endurance	Voltage proof C, DF and insulation
Endurance	According to fig.2 with U ₂ =1000VAC X: U ₁ =1.25U _R VAC	No visible damage; No open or; Short circuit
Vibration	3 directions at 2 hours each 10-500Hz at 0.75mm or 98 m/s ²	No visible damage; No open or Short circuit
Bump	4000 bumps at 390m/s ²	No visible damage
Change or temperature	Upper and lower rated temperature 5 cycles	Wetting time for d≤0.8<1s; d>0.8<1.5s
Solderability	Solder globule method	3, 10 or 30s burning time depending on flammability class
Passive flammability	Flame exposure time depending on severity	No flame
Active flammability	Surge pulses +U _R VAC	21 days
Humidity	+40°C and 9-95% R.H.	

5. MEASURING & TESTING EQUIPMENTS:

1. Capacitance and Dissipation Factor (tan δ)
 - a. Hewlett Packard 4284A Precision LCR Meter;
 - b. NF 2322 LCR Meter;
 - c. Chen Hwa 104 LCR Meter.
2. Insulation Resistance:
 - a. Hewlett Packard 4329A High Resistance Meter;
 - b. TOA SM-8205 Super Megohm Meter.
3. Environmental Test Chamer:
 - a. King Son THS-A4L;
 - b. C Sun Hcc-2;
 - c. Tabai PR-1.
4. Dielectric Strength Test:

Good will GPT-515AD Puncture tester.

6. Construction

1. Tinned copper wire leads
2. Metal spray
3. Metallized polypropylene film dielectric,
4. Flame retardant epoxy resin coating

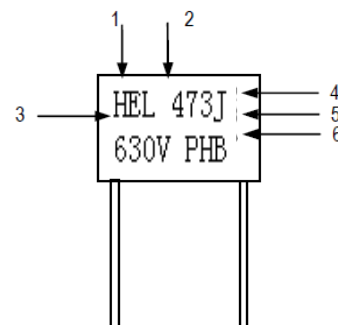
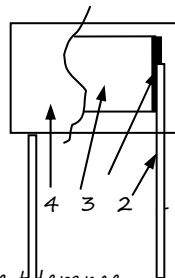

7. MARKING :

1. Norminal capacitance in μF; 2. Capacitance tolerance.
3. The trade mark of HEL ELECTRONIC LTD
4. Type of materia (Polypropylene); 5. AC rated voltage. 6. Safety approvals mark

PLASTIC FILM CAPACITORS

8. LEAD TAPING AND PACKAGING OF RADIAL COMPONENTS FOR ROBOT INSERTION MACHINES

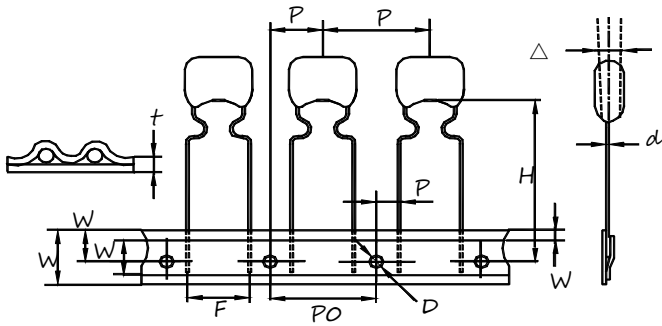

Fig. 1 Pitch=5 and

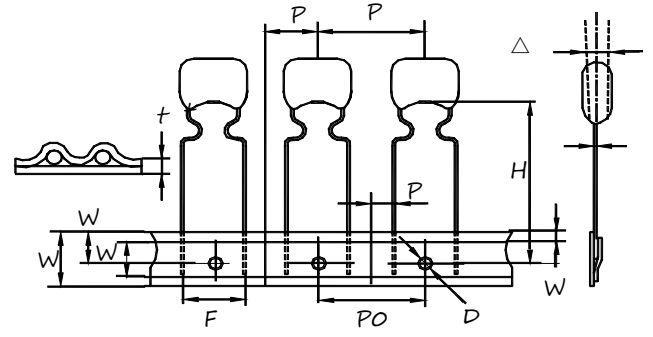

Fig. 2 Pitch=

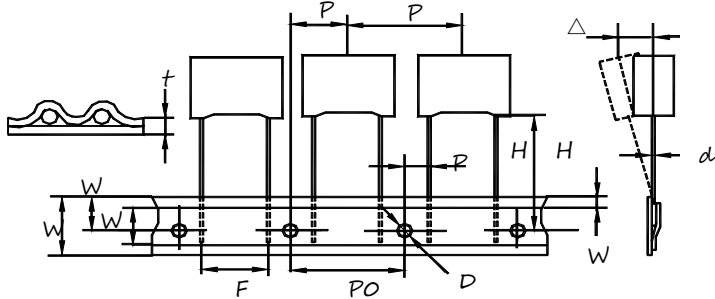

Fig. 1 Pitch=5 and 7.5mm

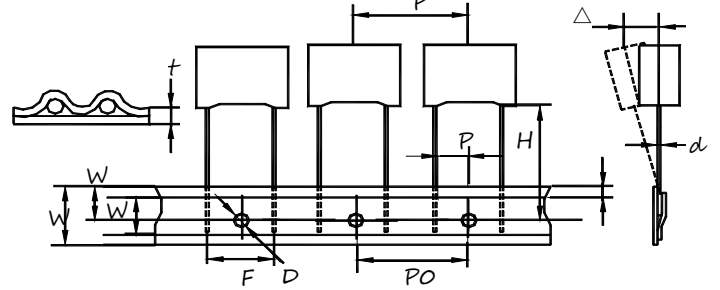

Fig. 2 Pitch=

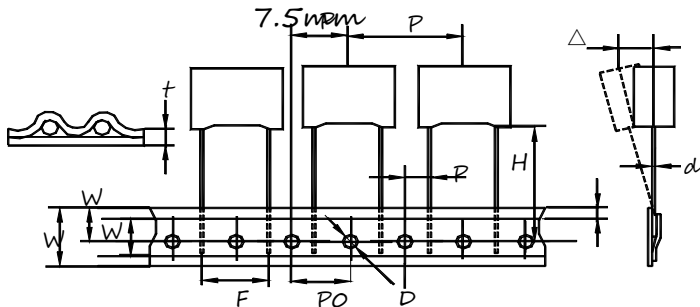

Fig. 3 Pitch=10 and

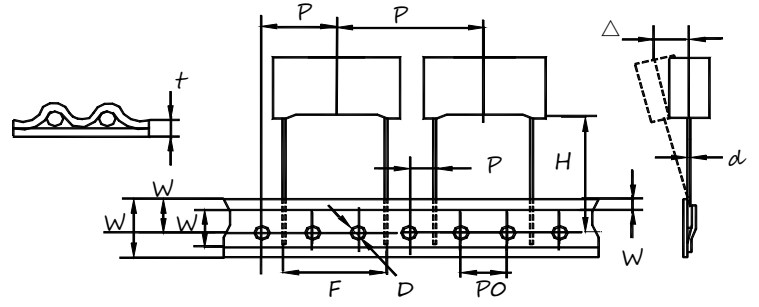

Fig. 4 Pitch=22.5 and

Description	Letter	Dimension (mm)						Tol.
		Fig.1 P=5mm	Fig.1/ P=7.5mm	Fig.3 P=10mm	Fig.3 P=15mm	Fig.4 P=22.5mm	Fig.4 P=27.5mm	
Lead wire diameter	d	0.5/0.6	0.5/0.6	0.6	0.6/0.8	0.8	0.8	±0.05
Taping pitch	P	12.7	12.7	25.4	25.4	38.1	38.1	±1
Feed hole pitch	PO	12.7	12.7	12.7	12.7	12.7	12.7	±0.2
Centering of the lead	P1	3.85	2.6/3.75	7.7	5.2	7.8	5.3	±0.7
Centering of the body	P2	6.35	6.35	12.7	12.7	19.05	19.05	±1.3
Lead spacing (pitch)	F	5	7.5	10	15	22.5	27.5	+0.6;
Component	Δh	0	0	0	0	0	0	±2
Height of component	H	18.5	18.5	18.5	18.5	18.5	18.5	±0.5
Carrier tape width	W	18	18	18	18	18	18	+1; -0.5
Hold down tape	WO	6	6	9	10	10	10	min
Hole position	W1	9	9	9	9	9	9	±0.5
Hold down tape	W2	3	3	3	3	3	3	max
Feed hole diameter	Do	4	4	4	4	4	4	±0.2
Tape thickness	t	0.7	0.7	0.7	0.7	0.7	0.7	±0.2

Remark: *Allowance of accumulated pitch less than 1mm at the sum of 20 pitches.

*Continuous empty component less than 3 pcs.

*Total empty on one reel less than

9. PACKING SPECIFICATIONS

PACKING TYPE	REEL PACKING		AMMO BOX PACKING	
DIMENSIONS UNIT:MM	A	14~30	A	50 ⁺⁰ _{-0.2}
	B	80 MIN	B	260±2
	D	370 MAX	C	330±2
	W1	45 ⁺⁰ _{-0.2}		
	W2	55MAX		
PACKING Q'TY PER REE/BOX	C≤0.022 1500 PCS	C>0.022 1000 PCS	C≤0.047 1500 PCS	C>0.047 1000 PCS

EIA STANDARD RS-296-D

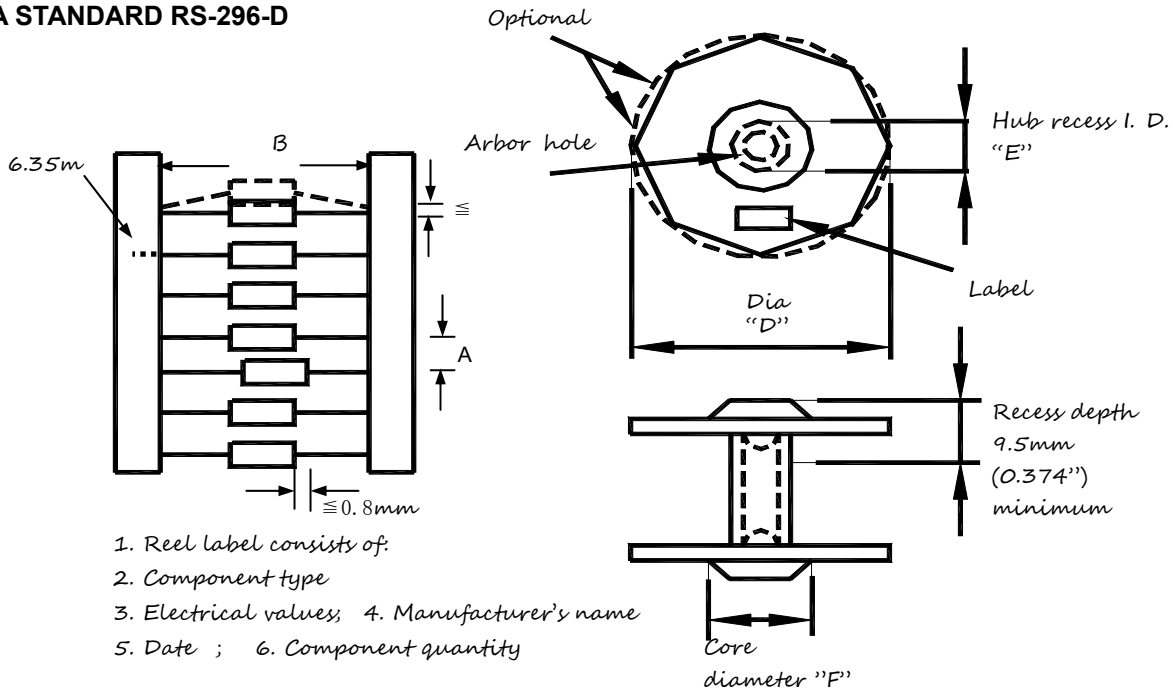

CAPACITOR BODY DIAMETER ≅5mm (≅0.197") 5.01~10mm (0.197~0.394") 10.01~15mm (0.394~0.591")	CAPACITOR PITCH "A" ±0.5mm (0.020") 5mm or 0.200" 10mm or 0.400" 15mm or 0.600"
---	---

CAPACITOR BODY LENGTH ≅16.50mm (≅0.65") 16.51~28.45mm (0.651~1.12") 28.46~37.00mm (1.121~1.45")	INSIDE TAPE SPACING "B" ±1.5mm (0.059") 52.44mm or 2.062" 63.5mm or 2.500" 76.0mm or 2.874"
---	---

	C	D	E	F
EIA Std. RF Spec	13.9~38.1mm (0.54~1.50") 14.50mm (0.570")	76.2~355.6mm (3.0~14.0") 381.0mm (15")	28.6~78.0mm (1.126~3.071") 54.2mm (2.130")	34.5~92.0mm (1.374~3.626") 61.0mm (2.401")

CAPACITOR BODY DIA.	PITCH	QUANTITY PCS/REEL
≅ 5.0mm	6mm	4000 max
5.1~7.0mm	10mm	2000 max
7.1~9.5mm	10mm	1000 max

10.METALLIZED POLYPROPYLENE FILM INTERFERENCE SUPPRESSION CAPACITOR--
-X2

Characteristics of voltage derating to frequency --- MPX

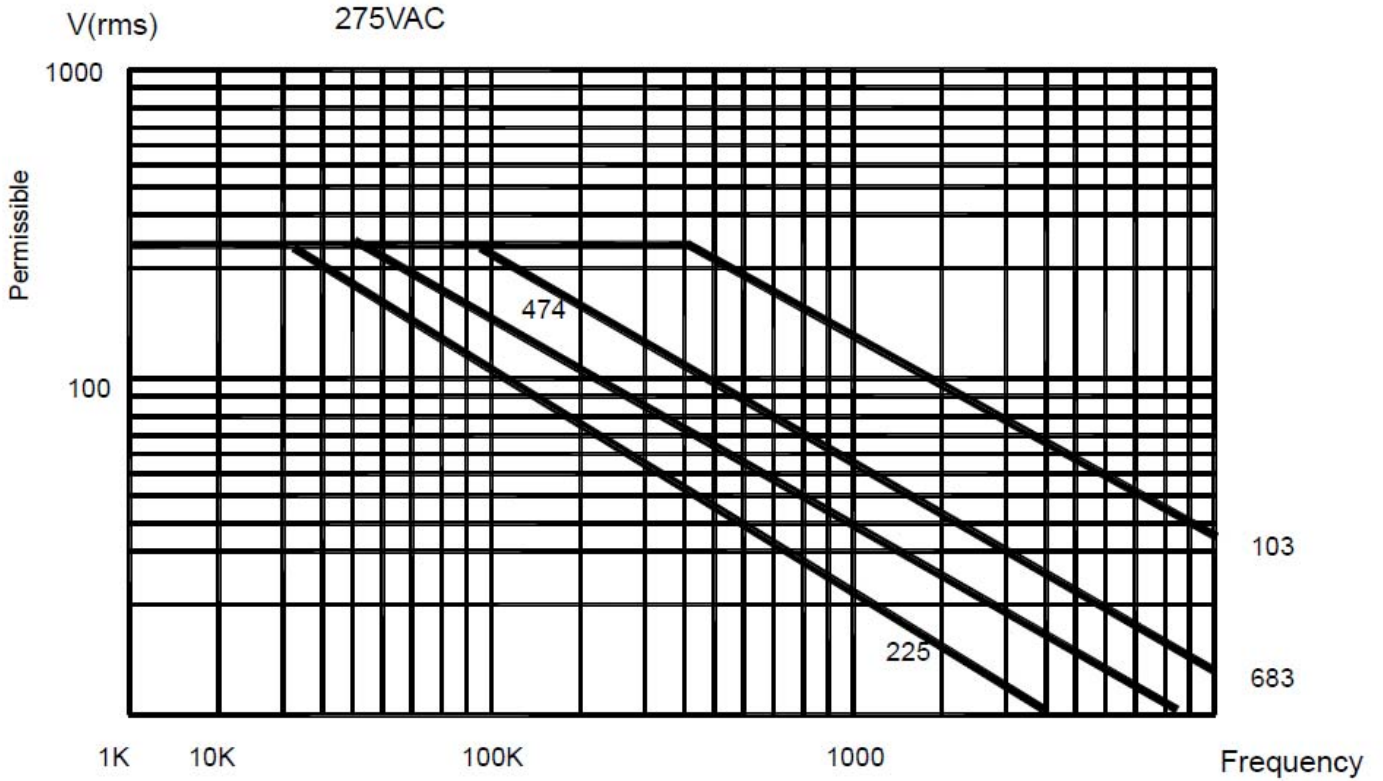

NOTE:

The graphs illustrated above are for reference only wave form of current and temperature rise of capacitor are key factors to determine permissible current. For actual applicant on. Consult our sales representative or sales office.