

FEATURES

- **Wide Supply Ranges**
 - **Single Supply: 2 V to 36 V**
(Tested to 30 V for Non-V Devices and 32 V for V-Suffix Devices)
 - **Dual Supplies: ± 1 V to ± 18 V**
(Tested to ± 15 V for Non-V Devices and ± 16 V for V-Suffix Devices)
- **Low Supply-Current Drain Independent of Supply Voltage: 0.8 mA (Typ)**
- **Low Input Bias Current: 25 nA (Typ)**
- **Low Input Offset Current: 3 nA (Typ) (139)**
- **Low Input Offset Voltage: 2 mV (Typ)**
- **Common-Mode Input Voltage Range Includes Ground**
- **Differential Input Voltage Range Equal to Maximum-Rated Supply Voltage: ± 36 V**
- **Low Output Saturation Voltage**
- **Output Compatible With TTL, MOS, and CMOS**

DESCRIPTION/ORDERING INFORMATION

These devices consist of four independent voltage comparators that are designed to operate from a single power supply over a wide range of voltages. Operation from dual supplies also is possible, as long as the difference between the two supplies is 2 V to 36 V, and V_{CC} is at least 1.5 V more positive than the input common-mode voltage. Current drain is independent of the supply voltage. The outputs can be connected to other open-collector outputs to achieve wired-AND relationships.

The XD239 and XL239 are characterized for operation from -25°C to 125°C . The XD339 and XL339 are characterized for operation from 0°C to 70°C . The 2901 are characterized for operation from -40°C to 125°C .

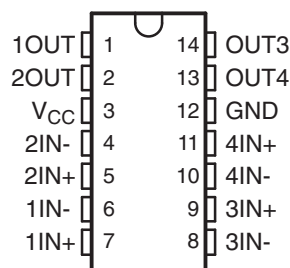

SYMBOL (EACH COMPARATOR)

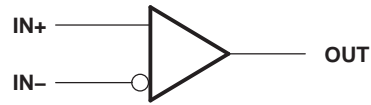

SCHEMATIC (EACH COMPARATOR)

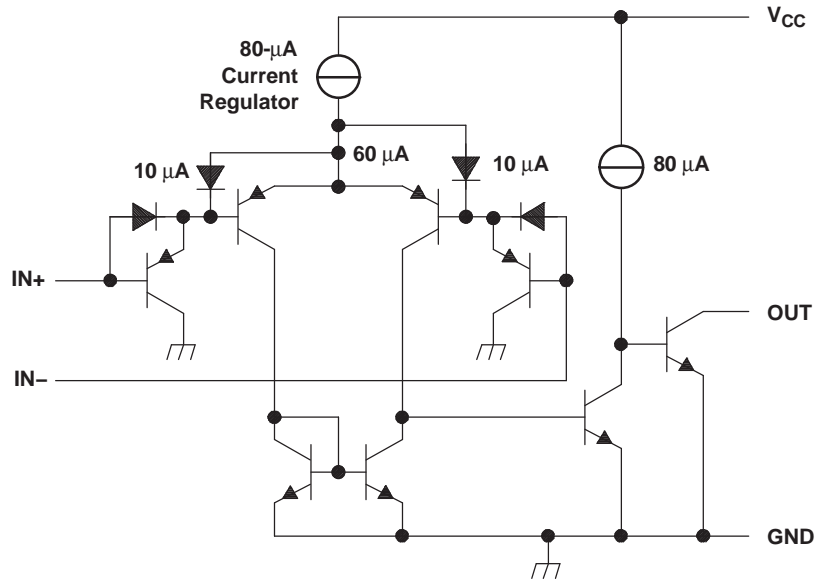

All current values shown are nominal.

ABSOLUTE MAXIMUM RATINGS⁽¹⁾

over operating free-air temperature range (unless otherwise noted)

		MIN	MAX	UNIT
V _{CC}	Supply voltage ⁽²⁾		36	V
V _{ID}	Differential input voltage ⁽³⁾		±36	V
V _I	Input voltage range (either input)	-0.3	36	V
V _O	Output voltage		36	V
I _O	Output current		20	mA
Duration of output short circuit to ground ⁽⁴⁾			Unlimited	
θ _{JA}	Package thermal impedance, junction to free air ^{(5) (6)}	D package	86	°C/W
		DB package	96	
		N package	80	
		NS package	76	
		PW package	113	
θ _{JC}	Package thermal impedance, junction to case ^{(7) (8)}	FK package	5.61	°C/W
		J package	15.05	
		W package	14.65	
T _J	Operating virtual-junction temperature		150	°C
	Case temperature for 60 s	FK package	260	°C
	Lead temperature 1,6 mm (1/16 in) from case for 60 s	J package	300	°C
T _{stg}	Storage temperature range	-65	150	°C

- (1) Stresses beyond those listed under "absolute maximum ratings" may cause permanent damage to the device. These are stress ratings only, and functional operation of the device at these or any other conditions beyond those indicated under "recommended operating conditions" is not implied. Exposure to absolute-maximum-rated conditions for extended periods may affect device reliability.
- (2) All voltage values, except differential voltages, are with respect to network ground.
- (3) Differential voltages are at IN+ with respect to IN-.
- (4) Short circuits from outputs to V_{CC} can cause excessive heating and eventual destruction.
- (5) Maximum power dissipation is a function of T_J (max), θ_{JA}, and T_A. The maximum allowable power dissipation at any allowable ambient temperature is P_D = (T_J (max) - T_A)/θ_{JA}. Operating at the absolute maximum T_J of 150°C can affect reliability.
- (6) The package thermal impedance is calculated in accordance with JEDEC 51-7.
- (7) Maximum power dissipation is a function of T_J (max), θ_{JC}, and T_C. The maximum allowable power dissipation at any allowable case temperature is P_D = (T_J (max) - T_C)/θ_{JC}. Operating at the absolute maximum T_J of 150°C can affect reliability.
- (8) The package thermal impedance is calculated in accordance with MIL-STD-883.

ELECTRICAL CHARACTERISTICS

at specified free-air temperature, $V_{CC} = 5\text{ V}$ (unless otherwise noted)

PARAMETER	TEST CONDITIONS ⁽¹⁾	T_A ⁽²⁾	XD239 XD339			XL239 XL339			UNIT	
			MIN	TYP	MAX	MIN	TYP	MAX		
V_{IO} Input offset voltage	$V_{CC} = 5\text{ V to }30\text{ V}$, $V_{IC} = V_{ICR\text{ min}}$, $V_O = 1.4\text{ V}$	25°C		2	5		1	3	mV	
		Full range			9			4		
I_{IO} Input offset current	$V_O = 1.4\text{ V}$	25°C		5	50		5	50	nA	
		Full range			150			150		
I_{IB} Input bias current	$V_O = 1.4\text{ V}$	25°C		-25	-250		-25	-250	nA	
		Full range			-400			-400		
V_{ICR} Common-mode input-voltage range ⁽³⁾		25°C	0 to $V_{CC} - 1.5$			0 to $V_{CC} - 1.5$			V	
		Full range	0 to $V_{CC} - 2$			0 to $V_{CC} - 2$				
A_{VD} Large-signal differential-voltage amplification	$V_{CC} = 15\text{ V}$, $V_O = 1.4\text{ V to }11.4\text{ V}$, $R_L \geq 15\text{ k}\Omega\text{ to }V_{CC}$	25°C		50	200		50	200	V/mV	
I_{OH} High-level output current	$V_{ID} = 1\text{ V}$	$V_{OH} = 5\text{ V}$	25°C		0.1	50		0.1	50	nA
		$V_{OH} = 30\text{ V}$	Full range			1			1	μA
V_{OL} Low-level output voltage	$V_{ID} = -1\text{ V}$, $I_{OL} = 4\text{ mA}$	25°C		150	400		150	400	mV	
		Full range			700			700		
I_{OL} Low-level output current	$V_{ID} = -1\text{ V}$, $V_{OL} = 1.5\text{ V}$	25°C		6	16		6	16	mA	
I_{CC} Supply current (four comparators)	$V_O = 2.5\text{ V}$, No load	25°C		0.8	2		0.8	2	mA	

- (1) All characteristics are measured with zero common-mode input voltage, unless otherwise specified.
 (2) Full range (MIN to MAX) for XD239/XL239 is -25°C to 85°C , and for XD339/XL339 is 0°C to 70°C . All characteristics are measured with zero common-mode input voltage, unless otherwise specified.
 (3) The voltage at either input or common-mode should not be allowed to go negative by more than 0.3 V. The upper end of the common-mode voltage range is $V_{CC+} - 1.5\text{ V}$; however, one input can exceed V_{CC} , and the comparator will provide a proper output state as long as the other input remains in the common-mode range. Either or both inputs can go to 30 V without damage.

SWITCHING CHARACTERISTICS

$V_{CC} = 5\text{ V}$, $T_A = 25^\circ\text{C}$

PARAMETER	TEST CONDITIONS	XD239 XL239 XD339 XL339		UNIT
		TYP		
Response time	R_L connected to 5 V through 5.1 k Ω , $C_L = 15\text{ pF}$ ^{(1) (2)}	100-mV input step with 5-mV overdrive		1.3
		TTL-level input step		0.3

- (1) C_L includes probe and jig capacitance.
 (2) The response time specified is the interval between the input step function and the instant when the output crosses 1.4 V.

ELECTRICAL CHARACTERISTICS

at specified free-air temperature, $V_{CC} = 5\text{ V}$ (unless otherwise noted)

PARAMETER	TEST CONDITIONS ⁽¹⁾		T_A ⁽²⁾	2901			UNIT
				MIN	TYP	MAX	
V_{IO} Input offset voltage	$V_{IC} = V_{ICR}\text{ min.}$ $V_O = 1.4\text{ V}$, $V_{CC} = 5\text{ V to MAX}^{(3)}$	Non-A devices	25°C	2	7	mV	
			Full range		15		
		A-suffix devices	25°C	1	2		
			Full range		4		
I_{IO} Input offset current	$V_O = 1.4\text{ V}$		25°C	5	50	nA	
			Full range		200		
I_{IB} Input bias current	$V_O = 1.4\text{ V}$		25°C	-25	-250	nA	
			Full range		-500		
V_{ICR} Common-mode input-voltage range ⁽⁴⁾			25°C	0 to $V_{CC} - 1.5$		V	
			Full range	0 to $V_{CC} - 2$			
A_{VD} Large-signal differential-voltage amplification	$V_{CC} = 15\text{ V}$, $V_O = 1.4\text{ V to } 11.4\text{ V}$, $R_L \geq 15\text{ k}\Omega\text{ to } V_{CC}$		25°C	25	100	V/mV	
I_{OH} High-level output current	$V_{ID} = 1\text{ V}$		$V_{OH} = 5\text{ V}$	25°C	0.1	50	nA
			$V_{OH} = V_{CC}\text{ MAX}^{(3)}$	Full range		1	μA
V_{OL} Low-level output voltage	$V_{ID} = -1\text{ V}$, $I_{OL} = 4\text{ mA}$	Non-V devices	25°C	150	500	mV	
		V-suffix devices		150	400		
		All devices	Full range		700		
I_{OL} Low-level output current	$V_{ID} = -1\text{ V}$,	$V_{OL} = 1.5\text{ V}$	25°C	6	16	mA	
I_{CC} Supply current (four comparators)	$V_O = 2.5\text{ V}$, No load		25°C	$V_{CC} = 5\text{ V}$	0.8	2	mA
				$V_{CC} = \text{MAX}^{(3)}$	1	2.5	

- (1) All characteristics are measured with zero common-mode input voltage, unless otherwise specified.
 (2) Full range (MIN to MAX) for 2901 is -40°C to 125°C . All characteristics are measured with zero common-mode input voltage, unless otherwise specified.
 (3) $V_{CC}\text{ MAX} = 30\text{ V}$ for non-V devices, and 32 V for V-suffix devices
 (4) The voltage at either input or common-mode should not be allowed to go negative by more than 0.3 V . The upper end of the common-mode voltage range is $V_{CC+} - 1.5\text{ V}$; however, one input can exceed V_{CC} , and the comparator will provide a proper output state as long as the other input remains in the common-mode range. Either or both inputs can go to $V_{CC}\text{ MAX}$ without damage.

SWITCHING CHARACTERISTICS

$V_{CC} = 5\text{ V}$, $T_A = 25^\circ\text{C}$

PARAMETER	TEST CONDITIONS		2901	UNIT
			TYP	
Response time	R_L connected to 5 V through $5.1\text{ k}\Omega$, $C_L = 15\text{ pF}^{(1)}\text{ }^{(2)}$	100-mV input step with 5-mV overdrive	1.3	μs
		TTL-level input step	0.3	

- (1) C_L includes probe and jig capacitance.
 (2) The response time specified is the interval between the input step function and the instant when the output crosses 1.4 V .

TYPICAL CHARACTERISTICS

**SUPPLY CURRENT
 vs
 SUPPLY VOLTAGE**

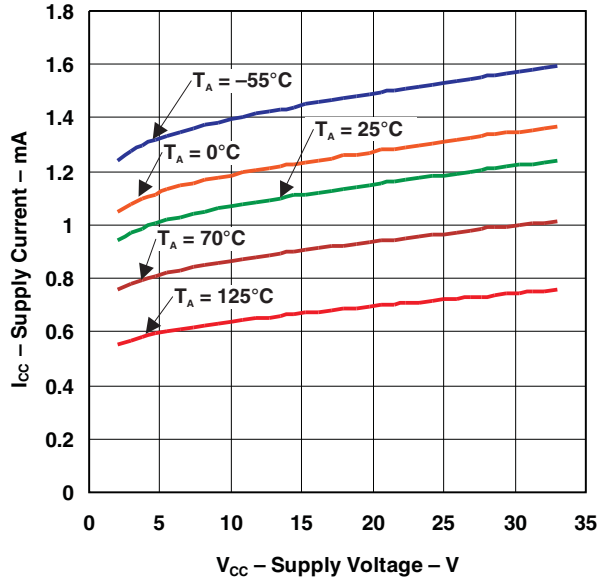

**INPUT BIAS CURRENT
 vs
 SUPPLY VOLTAGE**

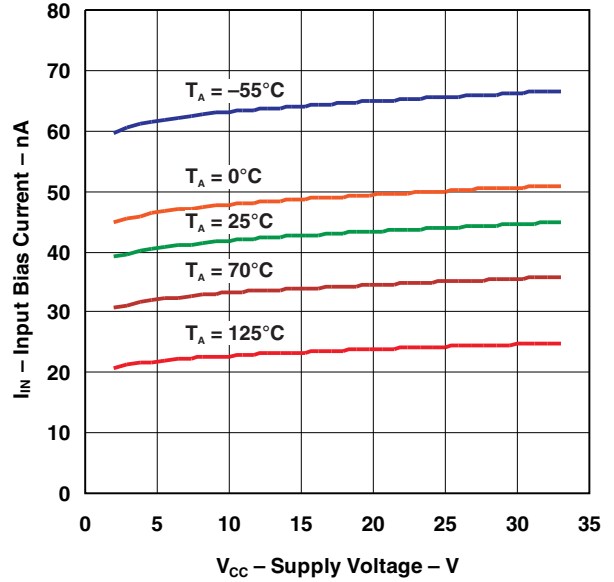

OUTPUT SATURATION VOLTAGE

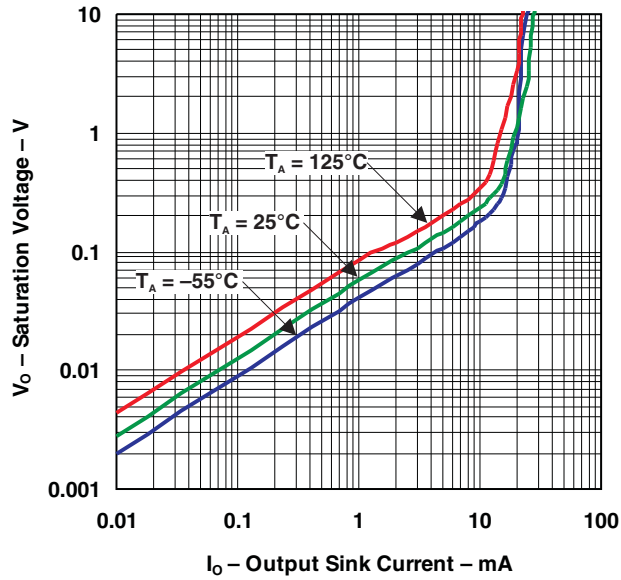

TYPICAL CHARACTERISTICS (continued)

RESPONSE TIME FOR VARIOUS OVERDRIVES
NEGATIVE TRANSITION

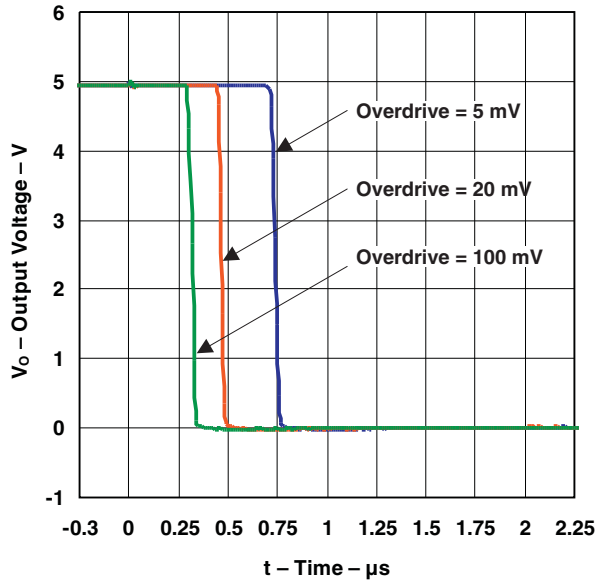

RESPONSE TIME FOR VARIOUS OVERDRIVES
POSITIVE TRANSITION

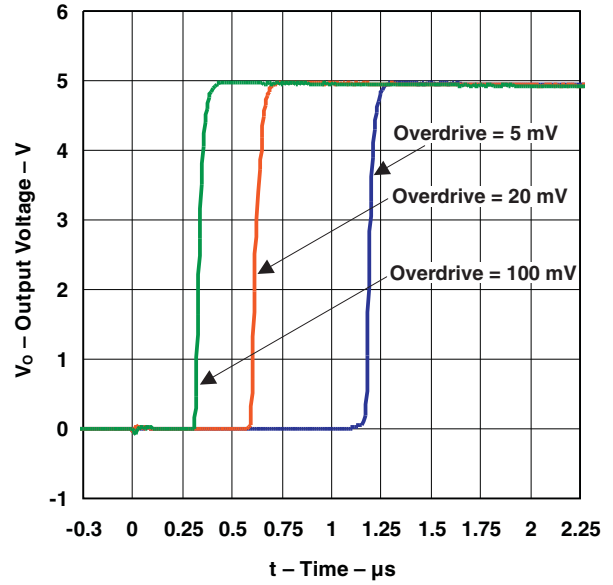

以上信息仅供参考. 如需帮助联系客服人员. 谢谢 XINLUDA