

Features

- Low operating voltage: $\pm 13.2V$
- Ultra low capacitance: 7pF typical
- Ultra low leakage: nA level
- Low clamping voltage
- 2-pin leadless package
- Complies with following standards:
 - – IEC 61000-4-2 (ESD) immunity test
 - Air discharge: $\pm 15kV$
 - Contact discharge: $\pm 8kV$
 - – IEC61000-4-5 (Lightning) 8A (8/20 μs)
- RoHS Compliant

Mechanical Characteristics

- Package: DFN1006-2 (1.0x0.6x0.5mm)
- Lead Finish: NiPdAu
- Case Material: "Green" Molding Compound.
- UL Flammability Classification Rating 94V-0
- Moisture Sensitivity: Level 3 per J-STD-020
- Terminal Connections: See Diagram Below



Applications

- Cellular Handsets & Accessories
- Personal Digital Assistants
- Display Port
- MDDI Ports
- Audio Players
- PCI Express
- Serial ATA

Ordering Information

Part Number	Qty per Reel	Reel Size
ESD13VB7-1006	10000or15000	7"

Dimensions and Pin Configuration

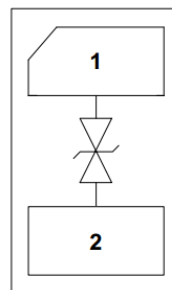
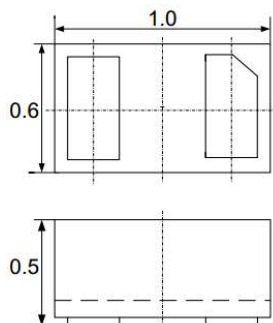

Marking: AA or H

Absolute Maximum Ratings (Tamb=25°C unless otherwise specified)

Parameter	Symbol	Value	Unit
Peak Pulse Power (8/20μs)	P _{PK}	150	W
Peak Pulse Current (8/20μs)	I _{PP}	8	A
ESD per IEC 61000-4-2 (Air)	V _{ESD}	±30	kV
ESD per IEC 61000-4-2 (Contact)		±30	
Operating Temperature Range	T _J	-55 to +125	°C
Storage Temperature Range	T _{stg}	-55 to +150	°C

Electrical Characteristics (TA=25°C unless otherwise specified)

Symbol	Parameter
V _{RWM}	Nominal Reverse Working Voltage
I _R	Reverse Leakage Current @ V _{RWM}
V _{BR}	Reverse Breakdown Voltage @ I _T
I _T	Test Current for Reverse Breakdown
V _C	Clamping Voltage @ I _{PP}
I _{PP}	Maximum Peak Pulse Current
C _{ESD}	Parasitic Capacitance
V _R	Reverse Voltage
f	Small Signal Frequency

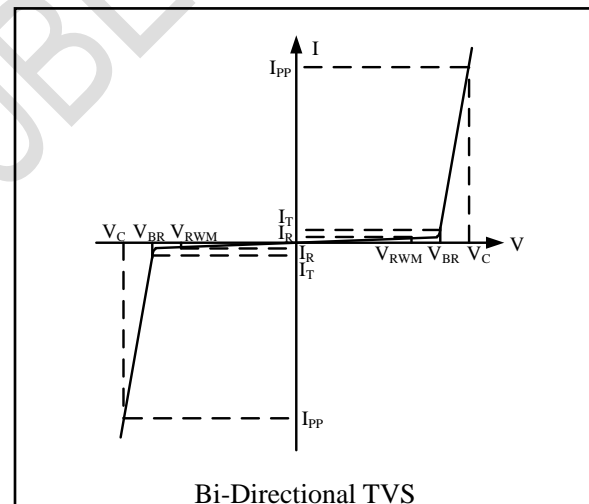

Parameter	Symbol	Min	Typ	Max	Unit	Test Condition
Reverse Working Voltage	V _{RWM}			13.2	V	
Breakdown Voltage	V _{BR}	13.7			V	I _T = 1mA
Reverse Leakage Current	I _R			100	nA	V _{RWM} = 12V
Clamping Voltage	V _C			20	V	I _{PP} = 7 A (8 x 20μs pulse)
Junction Capacitance	C _J		7	10	pF	V _R = 0V, f = 1MHz

Characteristic Curves

Fig1. 8/20 μ s Pulse Waveform

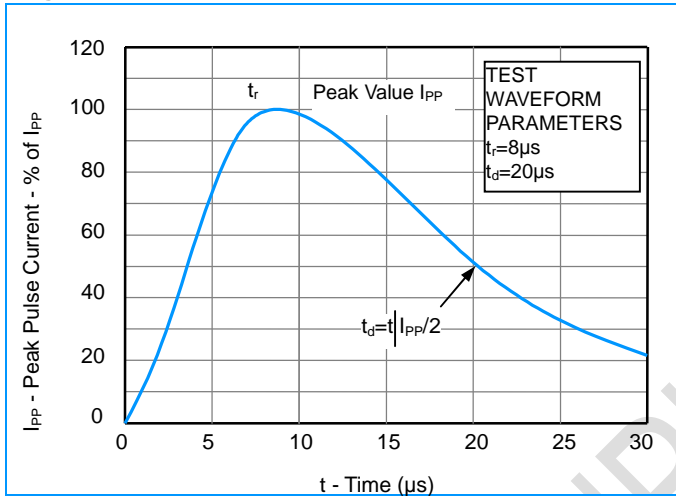

Fig2. ESD Pulse Waveform (according to IEC 61000-4-2)

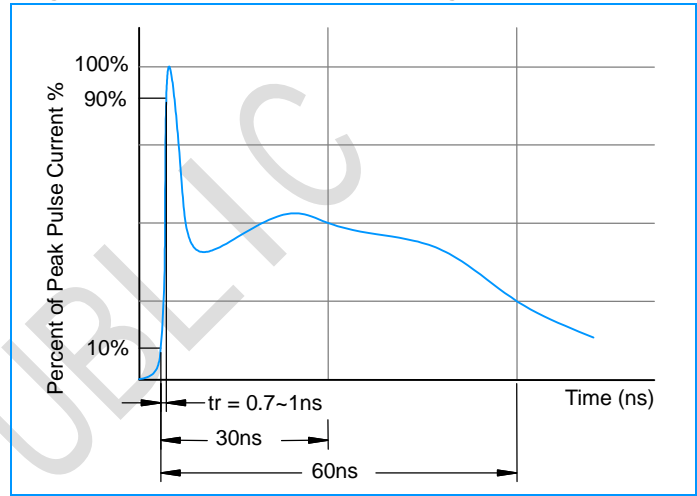

Fig3. Non - Repetitive Peak Pulse Power vs. Pulse Time

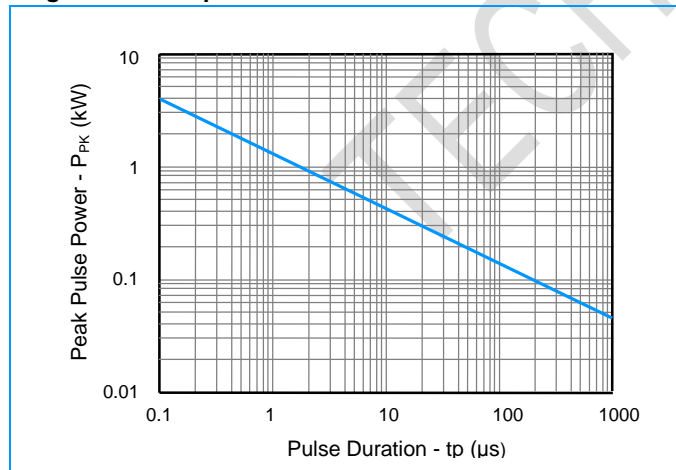
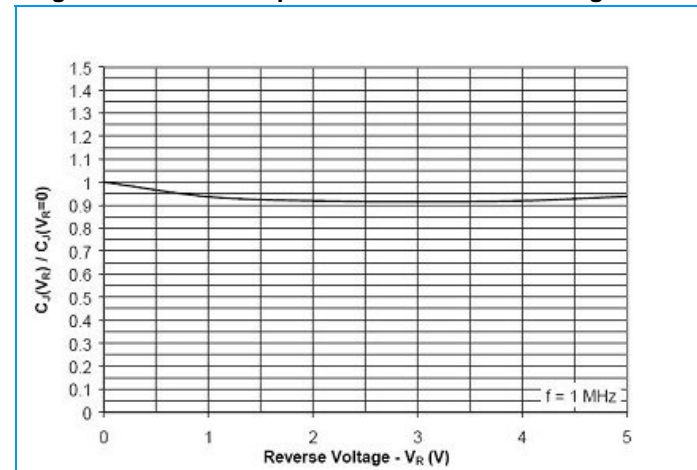
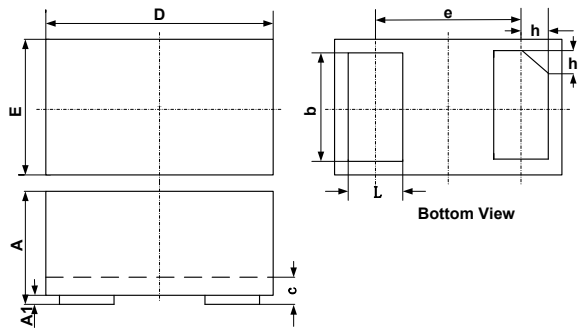

Fig4. Normalized Capacitance vs. Reverse Voltage



Outline Drawing - DFN1006-2



SYM	DIMENSIONS					
	MILLIMETERS			INCHES		
	MIN	NOM	MAX	MIN	NOM	MAX
A	0.45	0.50	0.55	0.018	0.020	0.022
A1	0.00	0.02	0.05	0.000	0.001	0.002
b	0.45	0.50	0.55	0.018	0.020	0.022
c	0.12	0.15	0.18	0.005	0.006	0.007
D	0.95	1.00	1.05	0.037	0.039	0.041
e	0.65 BSC			0.026 BSC		
E	0.55	0.60	0.65	0.022	0.024	0.026
L	0.20	0.25	0.30	0.008	0.010	0.012
h	0.07	0.12	0.17	0.003	0.005	0.007

Land Pattern - DFN1006-2

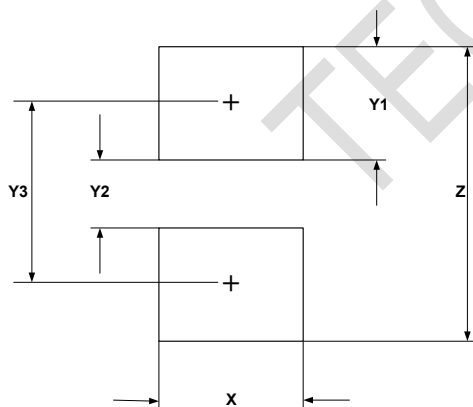

SYM	DIMENSIONS	
	MILLIMETERS	INCHES
X	0.60	0.024
Y1	0.50	0.020
Y2	0.30	0.012
Y3	0.80	0.032
Z	1.30	0.052