



Description

The HSM0048 is the high cell density trench N-ch MOSFETs, which provide excellent RDSON and gate charge for most of the Synchronous Rectification for AC/DC Quick Charger.

- 100% EAS Guaranteed
- Low $R_{DS(ON)}$
- Low Gate Charge
- RoHs and Halogen-Free Compliant

Product Summary

V_{DS}	100	V
$R_{DS(ON),max}$	8	m Ω
I_D	13.5	A

SOP8 Pin Configuration

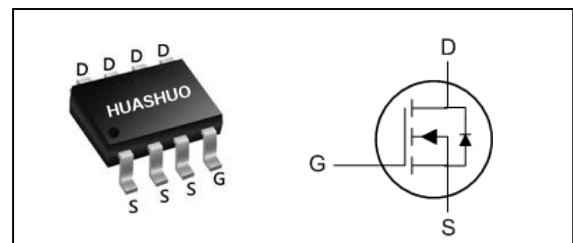

Absolute Maximum Ratings

Symbol	Parameter	Rating	Units
V_{DS}	Drain-Source Voltage	100	V
V_{GS}	Gate-Source Voltage	± 20	V
$I_D@T_A=25^\circ C$	Continuous Drain Current ¹	13.5	A
$I_D@T_A=70^\circ C$	Continuous Drain Current ¹	10.5	A
I_{DM}	Pulsed Drain Current ²	55	A
EAS	Single Pulse Avalanche Energy ³	33	mJ
I_{AS}	Avalanche Current	15	A
$P_D@T_A=25^\circ C$	Total Power Dissipation ⁴	3.1	W
T_{STG}	Storage Temperature Range	-55 to 150	$^\circ C$
T_J	Operating Junction Temperature Range	-55 to 150	$^\circ C$

Thermal Data

Symbol	Parameter	Typ.	Max.	Unit
$R_{\theta JA}$	Thermal Resistance Junction-Ambient ¹ ($t \leq 10s$)	---	40	$^\circ C/W$
	Thermal Resistance Junction-Ambient ¹	---	75	$^\circ C/W$
$R_{\theta JC}$	Thermal Resistance Junction-Case ¹	---	24	$^\circ C/W$



Electrical Characteristics ($T_J=25\text{ }^\circ\text{C}$, unless otherwise noted)

Symbol	Parameter	Conditions	Min.	Typ.	Max.	Unit
BV_{DSS}	Drain-Source Breakdown Voltage	$V_{GS}=0V, I_D=250\mu A$	100	---	---	V
$R_{DS(ON)}$	Static Drain-Source On-Resistance ²	$V_{GS}=10V, I_D=13.5A$	---	6.6	8	m Ω
	Static Drain-Source On-Resistance ²	$V_{GS}=4.5V, I_D=11.5A$	---	8.7	10.5	
$V_{GS(th)}$	Gate Threshold Voltage	$V_{GS}=V_{DS}, I_D=250\mu A$	1.2	---	2.3	V
I_{DSS}	Drain-Source Leakage Current	$V_{DS}=80V, V_{GS}=0V, T_J=25^\circ C$	---	---	1	uA
		$V_{DS}=80V, V_{GS}=0V, T_J=55^\circ C$	---	---	5	
I_{GSS}	Gate-Source Leakage Current	$V_{GS}=\pm 20V, V_{DS}=0V$	---	---	± 100	nA
g_{fs}	Forward Transconductance	$V_{DS}=5V, I_D=13.5A$	---	75	---	S
Q_g	Total Gate Charge (10V)	$V_{DS}=50V, V_{GS}=10V, I_D=13.5A$	---	45	---	nC
Q_g	Total Gate Charge (4.5V)		---	19.3	---	
Q_{gs}	Gate-Source Charge		---	9.5	---	
Q_{gd}	Gate-Drain Charge		---	4.8	---	
$T_{d(on)}$	Turn-On Delay Time	$V_{DD}=50V, V_{GS}=10V, R_G=3\Omega, I_D=13.5A$	---	10	---	ns
T_r	Rise Time		---	6.5	---	
$T_{d(off)}$	Turn-Off Delay Time		---	45	---	
T_f	Fall Time		---	7.5	---	
C_{iss}	Input Capacitance	$V_{DS}=50V, V_{GS}=0V, f=1MHz$	---	3320	---	pF
C_{oss}	Output Capacitance		---	605	---	
C_{rss}	Reverse Transfer Capacitance		---	20	---	

Diode Characteristics

Symbol	Parameter	Conditions	Min.	Typ.	Max.	Unit
I_S	Continuous Source Current ^{1,5}	$V_G=V_D=0V, \text{Force Current}$	---	---	5	A
V_{SD}	Diode Forward Voltage ²	$V_{GS}=0V, I_S=1A, T_J=25^\circ C$	---	---	1.1	V
t_{rr}	Reverse Recovery Time	$I_F=13.5A, di/dt=100A/\mu s,$	---	33	---	nS
Q_{rr}	Reverse Recovery Charge	$T_J=25^\circ C$	---	150	---	nC

Note :

- 1.The data tested by surface mounted on a 1 inch² FR-4 board with 2OZ copper.
- 2.The data tested by pulsed , pulse width $\leq 300\mu s$, duty cycle $\leq 2\%$
- 3.The EAS data shows Max. rating . The test condition is $V_{DD}=25V, V_{GS}=10V, L=0.3mH, I_{AS}=15A$
- 4.The power dissipation is limited by 150 $^\circ\text{C}$ junction temperature
- 5.The data is theoretically the same as I_D and I_{DM} , in real applications , should be limited by total power dissipation.



Typical Characteristics

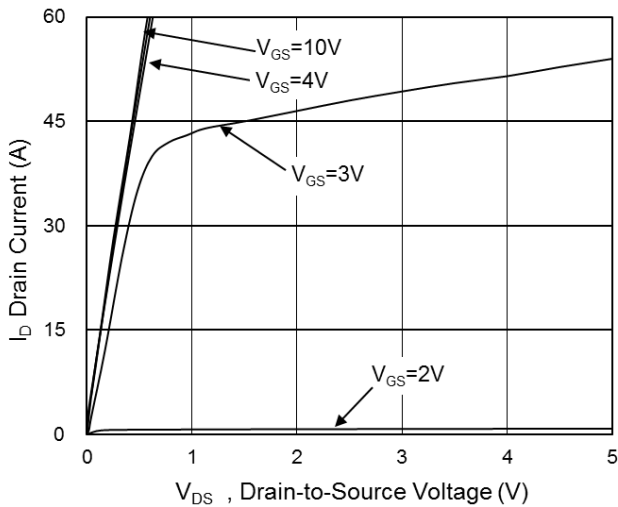

Fig.1 Typical Output Characteristics

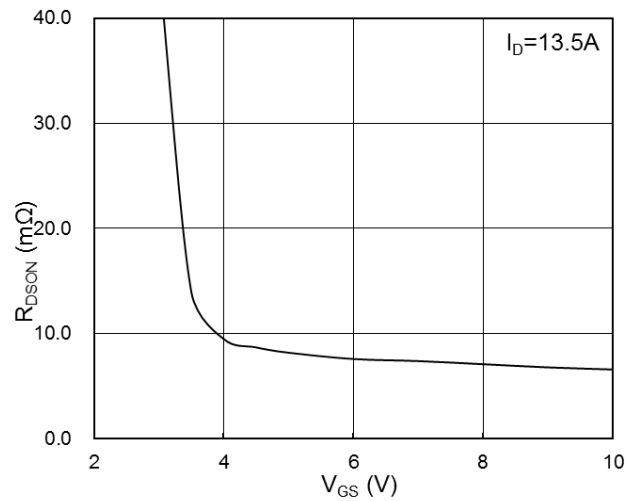

Fig.2 On-Resistance vs. G-S Voltage

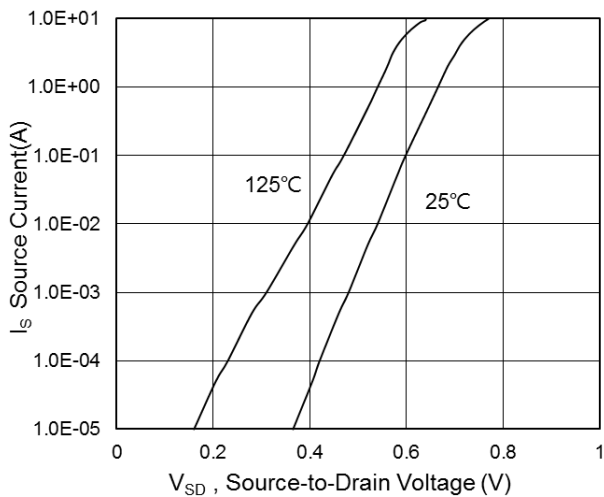

Fig.3 Source-Drain Forward Characteristics

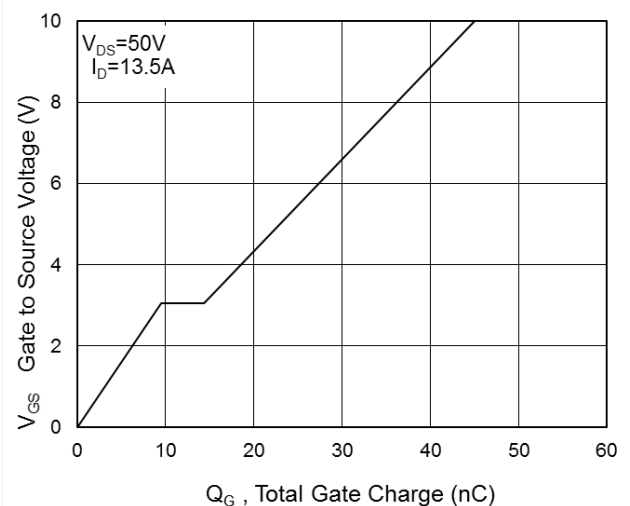

Fig.4 Gate-Charge Characteristics

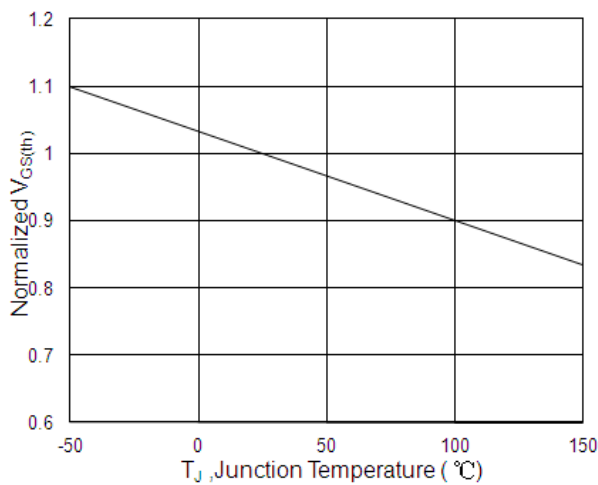

Fig.5 Normalized $V_{GS(th)}$ vs. T_J

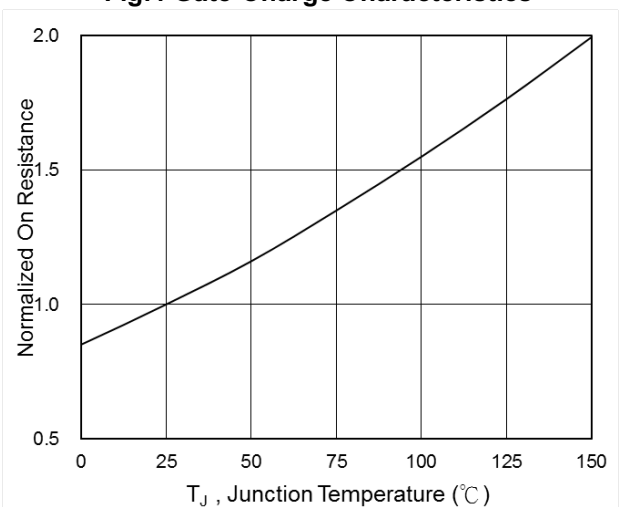

Fig.6 Normalized $R_{DS(on)}$ vs. T_J



N-Ch 100V Fast Switching MOSFETs

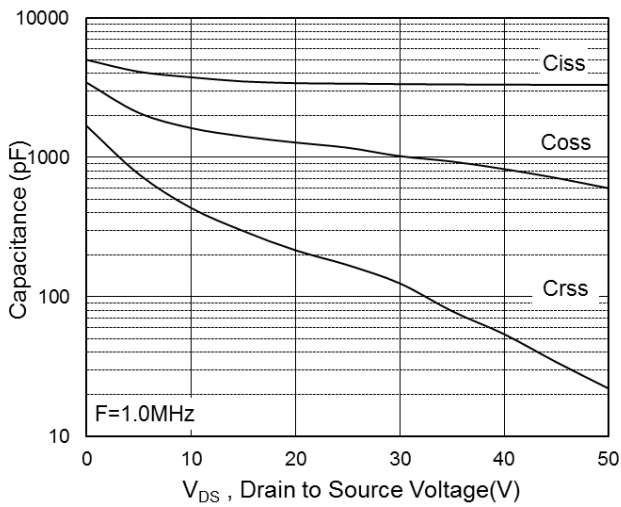

Fig.7 Capacitance

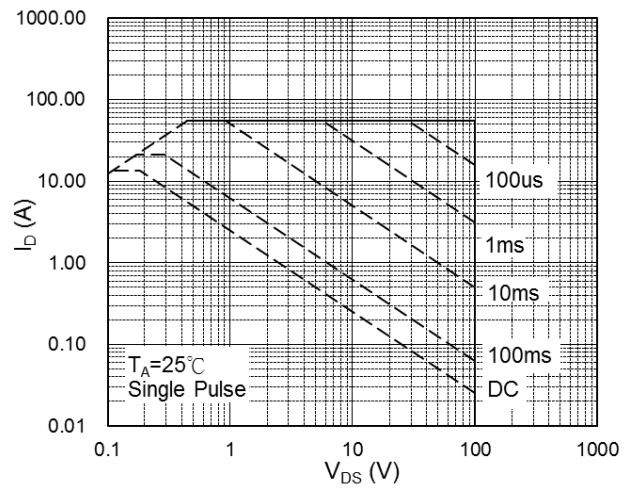

Fig.8 Safe Operating Area

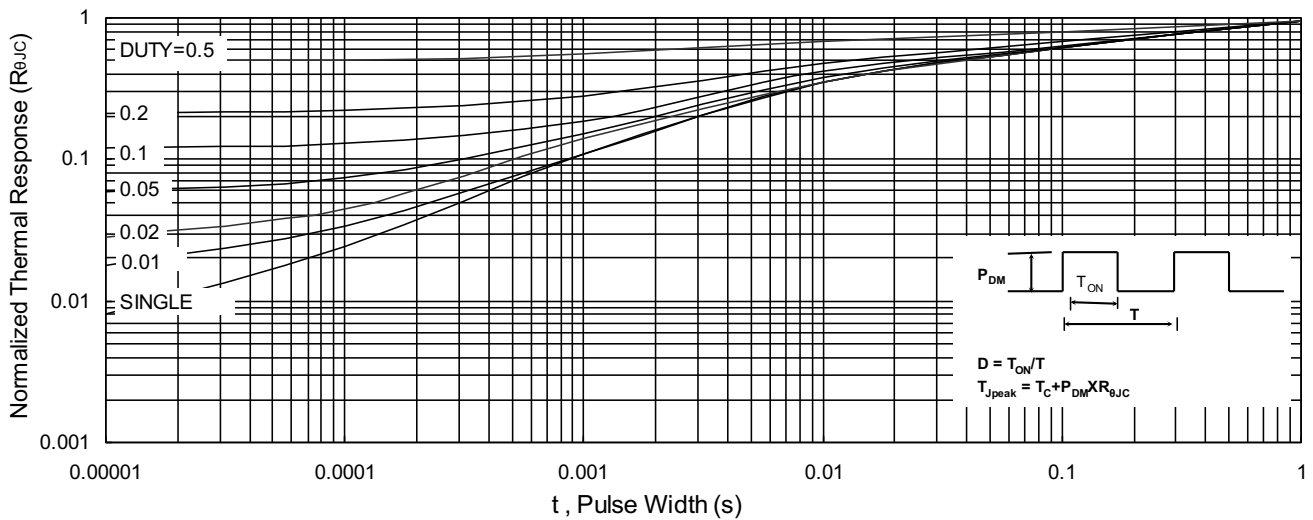

Fig.9 Normalized Maximum Transient Thermal Impedance

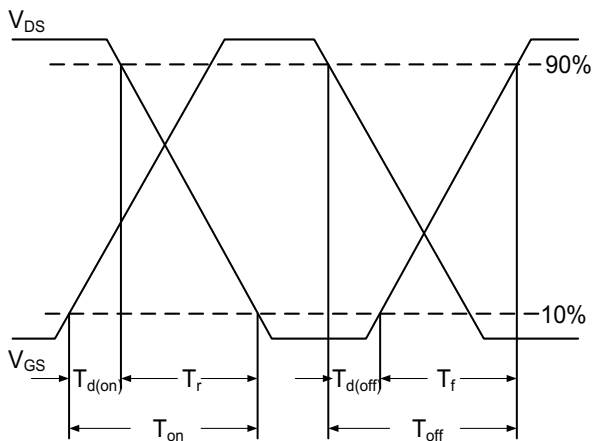

Fig.10 Switching Time Waveform

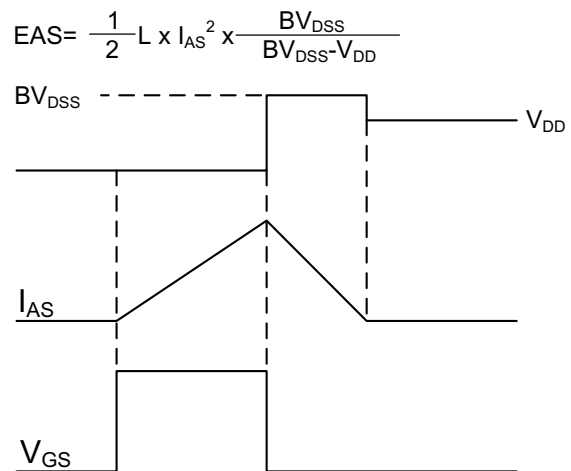

Fig.11 Unclamped Inductive Switching Waveform



Ordering Information

Part Number	Package code	Packaging
HSM0048	SOP-8	2500/Tape&Reel

