

N-Ch and P-Ch Fast Switching MOSFETs
Description

The HSU6903 is the high performance complementary N-ch and P-ch MOSFETs with high cell density, which provide excellent RDSON and gate charge for most of the synchronous buck converter applications.

The HSU6903 meet the RoHS and Green Product requirement, 100% EAS guaranteed with full function reliability approved.

- 100% EAS Guaranteed
- Green Device Available
- Super Low Gate Charge
- Excellent CdV/dt effect decline
- Advanced high cell density Trench technology

Product Summary

BVDSS	RDSON	ID
60V	40mΩ	20A
-60V	100mΩ	-12A

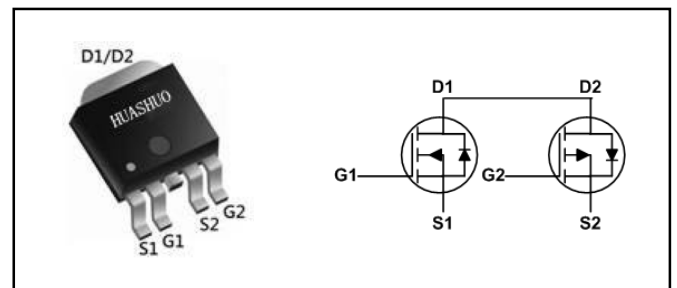
TO252-4 Pin Configuration

Absolute Maximum Ratings

Symbol	Parameter	Rating		Units
		N-Channel	P-Channel	
V_{DS}	Drain-Source Voltage	60	-60	V
V_{GS}	Gate-Source Voltage	± 20	± 20	V
$I_D@T_C=25^\circ C$	Continuous Drain Current, $V_{GS} @ 10V^1$	20	-12	A
$I_D@T_C=100^\circ C$	Continuous Drain Current, $V_{GS} @ 10V^1$	14	-8.5	A
I_{DM}	Pulsed Drain Current ²	60	-30	A
EAS	Single Pulse Avalanche Energy ³	22	29.8	mJ
I_{AS}	Avalanche Current	21	-24.4	A
$P_D@T_C=25^\circ C$	Total Power Dissipation ⁴	50	50	W
T_{STG}	Storage Temperature Range	-55 to 175	-55 to 175	$^\circ C$
T_J	Operating Junction Temperature Range	-55 to 175	-55 to 175	$^\circ C$

Thermal Data

Symbol	Parameter	Typ.	Max.	Unit
$R_{\theta JA}$	Thermal Resistance Junction-Ambient ¹	---	62	$^\circ C/W$
$R_{\theta JC}$	Thermal Resistance Junction-Case ¹	---	3	$^\circ C/W$



N-Channel Electrical Characteristics ($T_J=25\text{ }^\circ\text{C}$, unless otherwise noted)

Symbol	Parameter	Conditions	Min.	Typ.	Max.	Unit
BV_{DSS}	Drain-Source Breakdown Voltage	$V_{GS}=0V, I_D=250\mu A$	60	---	---	V
$R_{DS(ON)}$	Static Drain-Source On-Resistance ²	$V_{GS}=10V, I_D=15A$	---	---	40	m Ω
		$V_{GS}=4.5V, I_D=7A$	---	---	50	
$V_{GS(th)}$	Gate Threshold Voltage	$V_{GS}=V_{DS}, I_D=250\mu A$	1.0	---	2.5	V
I_{DSS}	Drain-Source Leakage Current	$V_{DS}=48V, V_{GS}=0V, T_J=25^\circ C$	---	---	1	μA
		$V_{DS}=48V, V_{GS}=0V, T_J=55^\circ C$	---	---	5	
I_{GSS}	Gate-Source Leakage Current	$V_{GS}=\pm 20V, V_{DS}=0V$	---	---	± 100	nA
g_{fs}	Forward Transconductance	$V_{DS}=5V, I_D=15A$	---	25.3	---	S
Q_g	Total Gate Charge (10V)	$V_{DS}=48V, V_{GS}=10V, I_D=15A$	---	19	---	nC
Q_{gs}	Gate-Source Charge		---	2.5	---	
Q_{gd}	Gate-Drain Charge		---	5	---	
$T_{d(on)}$	Turn-On Delay Time	$V_{DD}=30V, V_{GS}=10V, R_G=3.3\Omega$ $I_D=15A$	---	2.8	---	ns
T_r	Rise Time		---	16.6	---	
$T_{d(off)}$	Turn-Off Delay Time		---	21.2	---	
T_f	Fall Time		---	5.6	---	
C_{iss}	Input Capacitance	$V_{DS}=15V, V_{GS}=0V, f=1MHz$	---	1027	---	pF
C_{oss}	Output Capacitance		---	65	---	
C_{rss}	Reverse Transfer Capacitance		---	46	---	

Diode Characteristics

Symbol	Parameter	Conditions	Min.	Typ.	Max.	Unit
I_S	Continuous Source Current ^{1,6}	$V_G=V_D=0V$, Force Current	---	---	10	A
V_{SD}	Diode Forward Voltage ²	$V_{GS}=0V, I_S=1A, T_J=25^\circ C$	---	---	1.2	V

Note :

- 1.The data tested by surface mounted on a 1 inch² FR-4 board with 2OZ copper.
- 2.The data tested by pulsed , pulse width $\leq 300\mu s$, duty cycle $\leq 2\%$
- 3.The EAS data shows Max. rating . The test condition is $V_{DD}=25V, V_{GS}=10V, L=0.1mH, I_{AS}=21A$
- 4.The power dissipation is limited by 150 $^\circ C$ junction temperature
- 5.The data is theoretically the same as I_D and I_{DM} , in real applications , should be limited by total power dissipation.



P-Channel Electrical Characteristics (T_J=25 °C, unless otherwise noted)

Symbol	Parameter	Conditions	Min.	Typ.	Max.	Unit
BV _{DSS}	Drain-Source Breakdown Voltage	V _{GS} =0V, I _D =-250uA	-60	---	---	V
R _{DS(ON)}	Static Drain-Source On-Resistance ²	V _{GS} =-10V, I _D =-10A	---	---	100	mΩ
		V _{GS} =-4.5V, I _D =-5A	---	---	125	
V _{GS(th)}	Gate Threshold Voltage	V _{GS} =V _{DS} , I _D =-250uA	-1.0	---	-2.5	V
I _{DSS}	Drain-Source Leakage Current	V _{DS} =-48V, V _{GS} =0V, T _J =25°C	---	---	1	uA
		V _{DS} =-48V, V _{GS} =0V, T _J =55°C	---	---	5	
I _{GSS}	Gate-Source Leakage Current	V _{GS} =±20V, V _{DS} =0V	---	---	±100	nA
g _{fs}	Forward Transconductance	V _{DS} =-5V, I _D =-4A	---	8.7	---	S
Q _g	Total Gate Charge (-4.5V)	V _{DS} =-12V, V _{GS} =-4.5V, I _D =-6A	---	11.8	---	nC
Q _{gs}	Gate-Source Charge		---	1.9	---	
Q _{gd}	Gate-Drain Charge		---	6.5	---	
T _{d(on)}	Turn-On Delay Time	V _{DD} =-15V, V _{GS} =-10V, R _G =3.3Ω, I _D =-1A	---	8.8	---	ns
T _r	Rise Time		---	19.6	---	
T _{d(off)}	Turn-Off Delay Time		---	47.2	---	
T _f	Fall Time		---	9.6	---	
C _{iss}	Input Capacitance	V _{DS} =-15V, V _{GS} =0V, f=1MHz	---	1080	---	pF
C _{oss}	Output Capacitance		---	73	---	
C _{rss}	Reverse Transfer Capacitance		---	50	---	

Diode Characteristics

Symbol	Parameter	Conditions	Min.	Typ.	Max.	Unit
I _S	Continuous Source Current ^{1,5}	V _G =V _D =0V, Force Current	---	---	-10	A
V _{SD}	Diode Forward Voltage ²	V _{GS} =0V, I _S =-1A, T _J =25°C	---	---	-1	V

Note :

- 1.The data tested by surface mounted on a 1 inch² FR-4 board with 2OZ copper.
- 2.The data tested by pulsed, pulse width ≤ 300us, duty cycle ≤ 2%
- 3.The EAS data shows Max. rating. The test condition is V_{DD}=-25V, V_{GS}=-10V, L=0.1mH, I_{AS}=-24.4A
- 4.The power dissipation is limited by 150°C junction temperature
- 5.The data is theoretically the same as I_D and I_{DM}, in real applications, should be limited by total power dissipation.



N-Channel Typical Characteristics

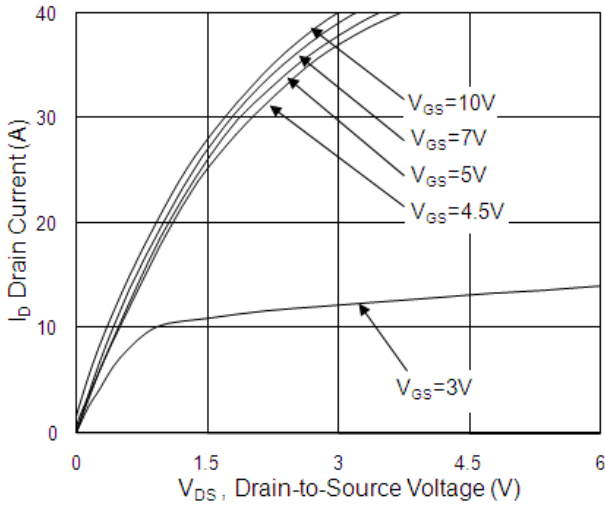

Fig.1 Typical Output Characteristics

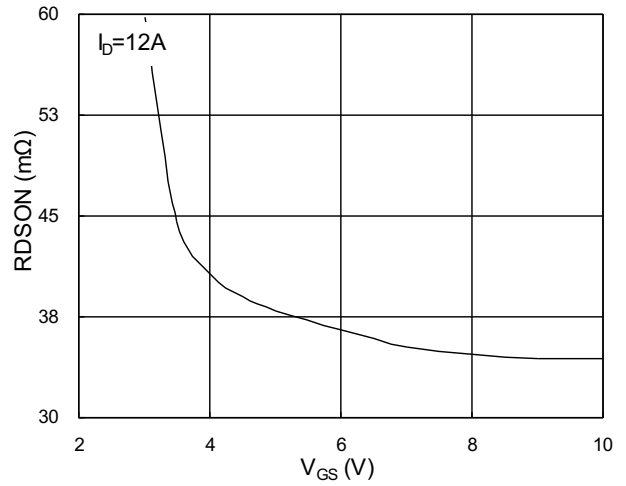

Fig.2 On-Resistance vs. G-S Voltage

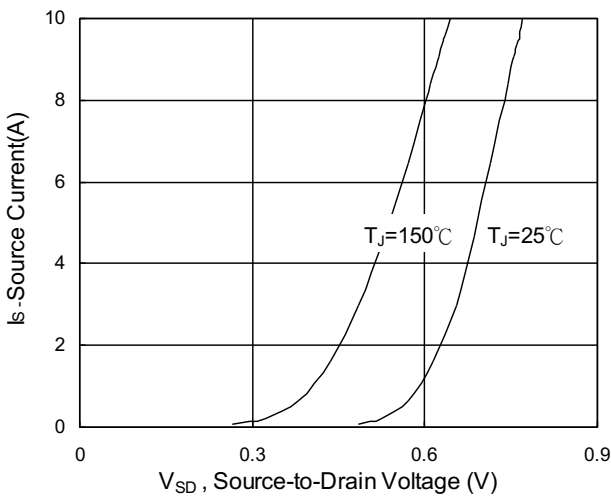

Fig.3 Source Drain Forward Characteristics

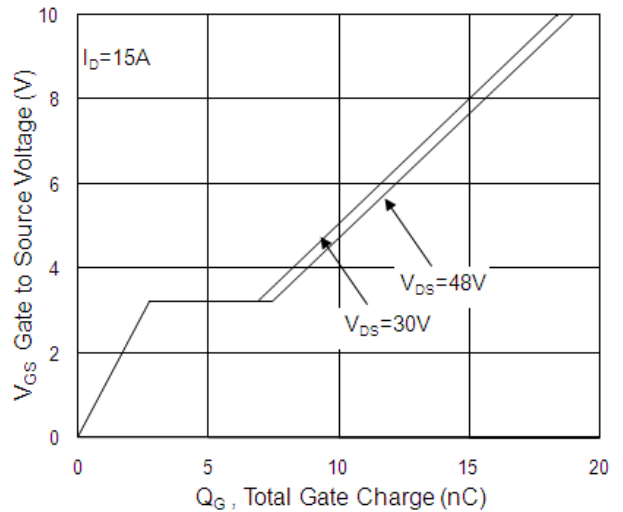

Fig.4 Gate-Charge Characteristics

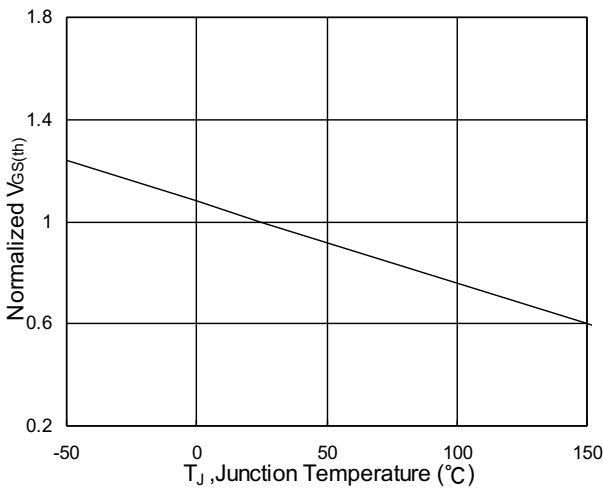

Fig.5 Normalized $V_{GS(th)}$ vs. T_J

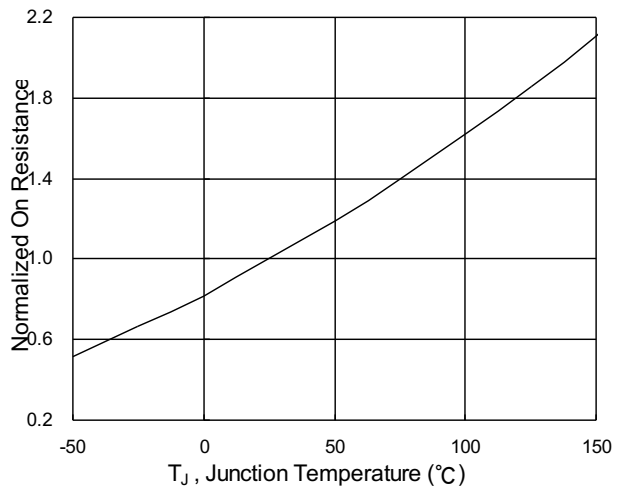

Fig.6 Normalized $R_{DS(on)}$ vs. T_J



N-Ch and P-Ch Fast Switching MOSFETs

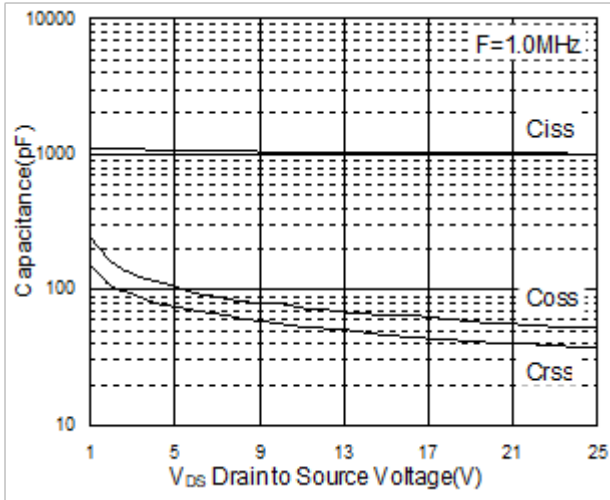

Fig.7 Capacitance

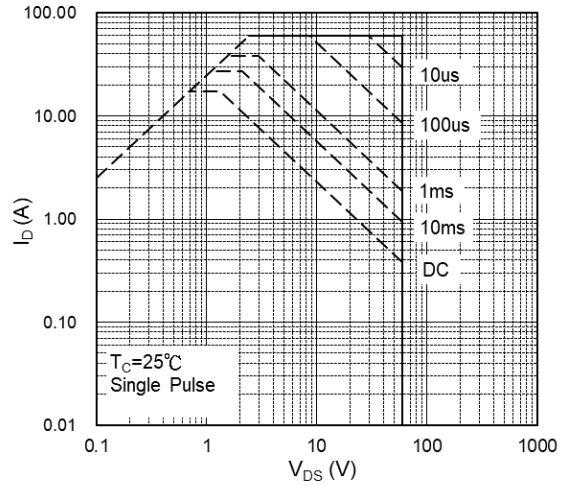

Fig.8 Safe Operating Area

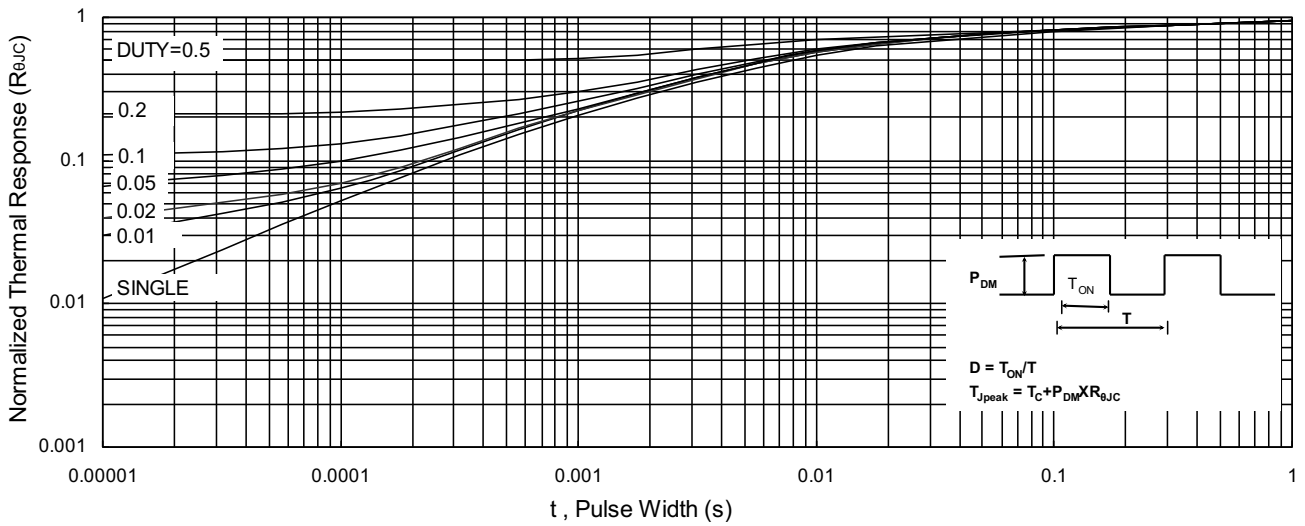

Fig.9 Normalized Maximum Transient Thermal Impedance

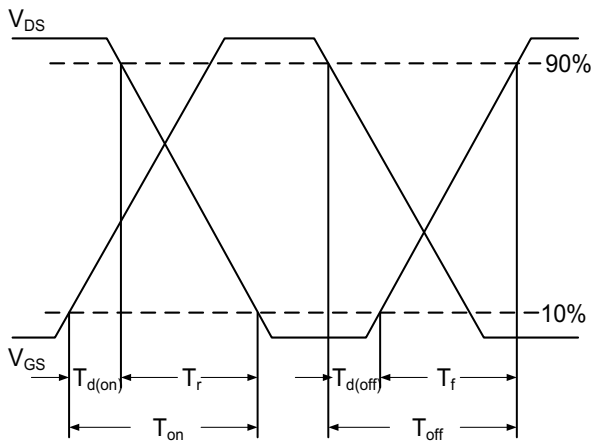

Fig.10 Switching Time Waveform

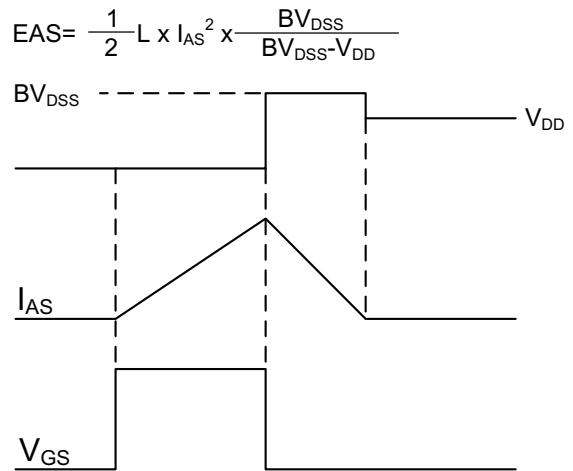

Fig.11 Unclamped Inductive Switching

N-Ch and P-Ch Fast Switching MOSFETs

P-Channel Typical Characteristics

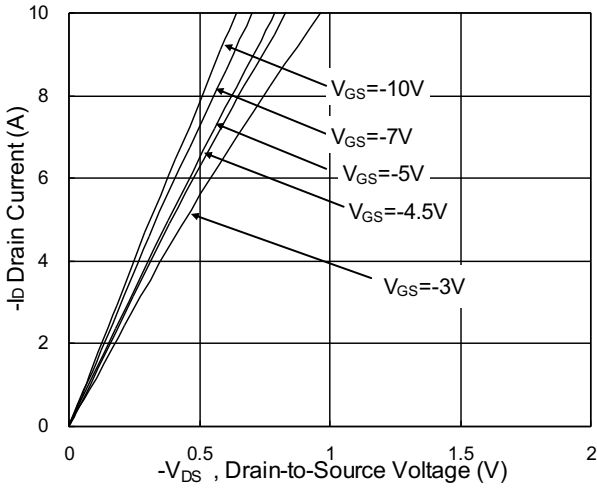

Fig.1 Typical Output Characteristics

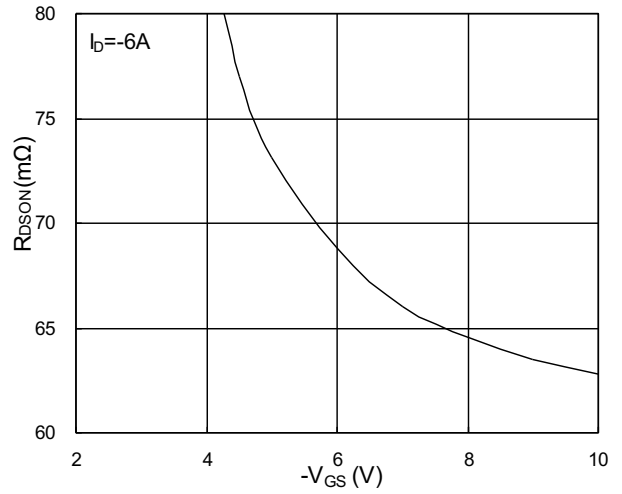

Fig.2 On-Resistance vs. G-S Voltage

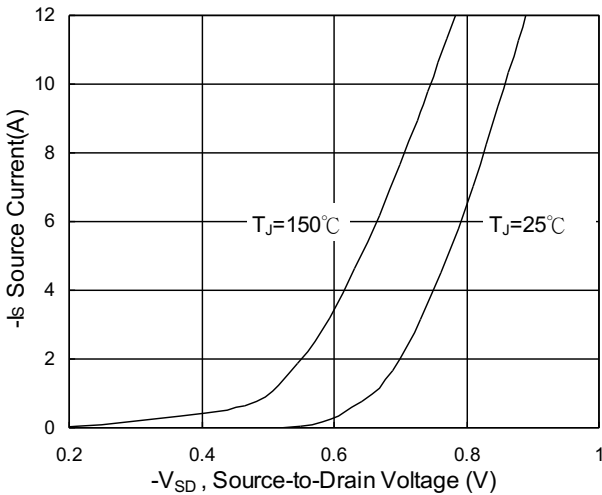

Fig.3 Source Drain Forward Characteristics

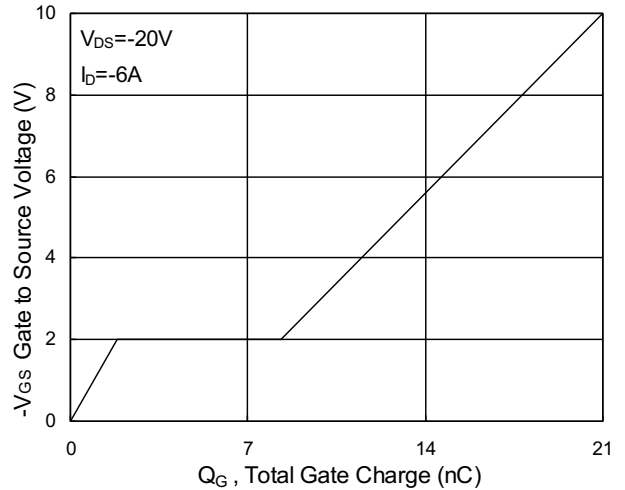

Fig.4 Gate-Charge Characteristics

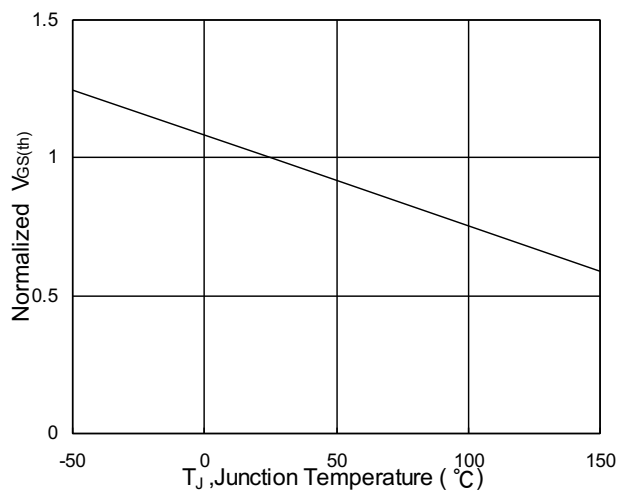

Fig.5 Normalized V_{GS(th)} vs. T_j

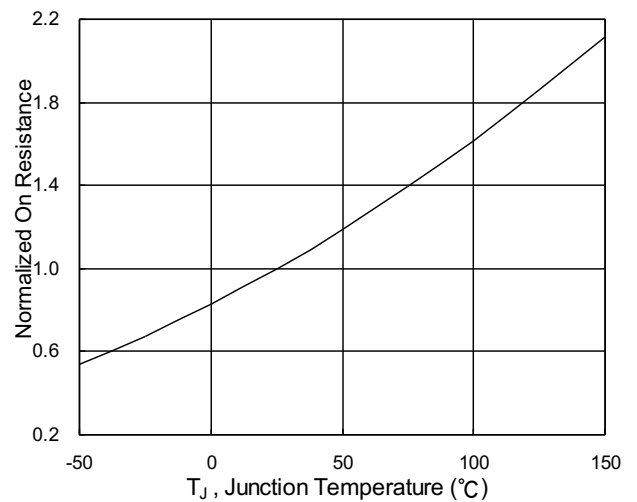

Fig.6 Normalized R_{DS(on)} vs. T_j



N-Ch and P-Ch Fast Switching MOSFETs

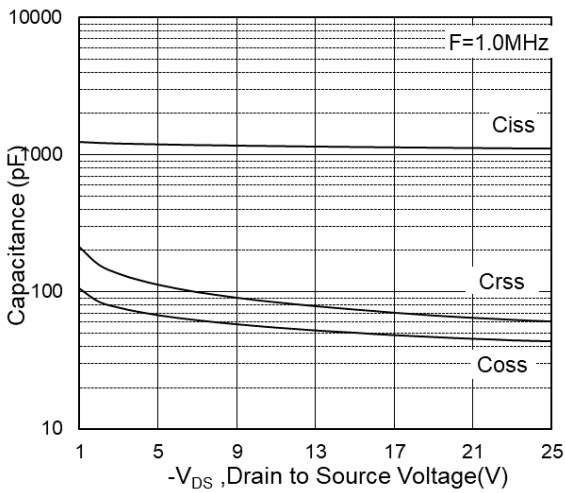

Fig.7 Capacitance

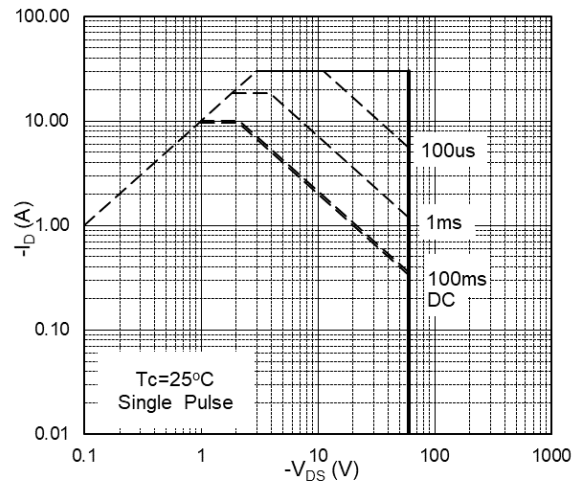

Fig.8 Safe Operating Area

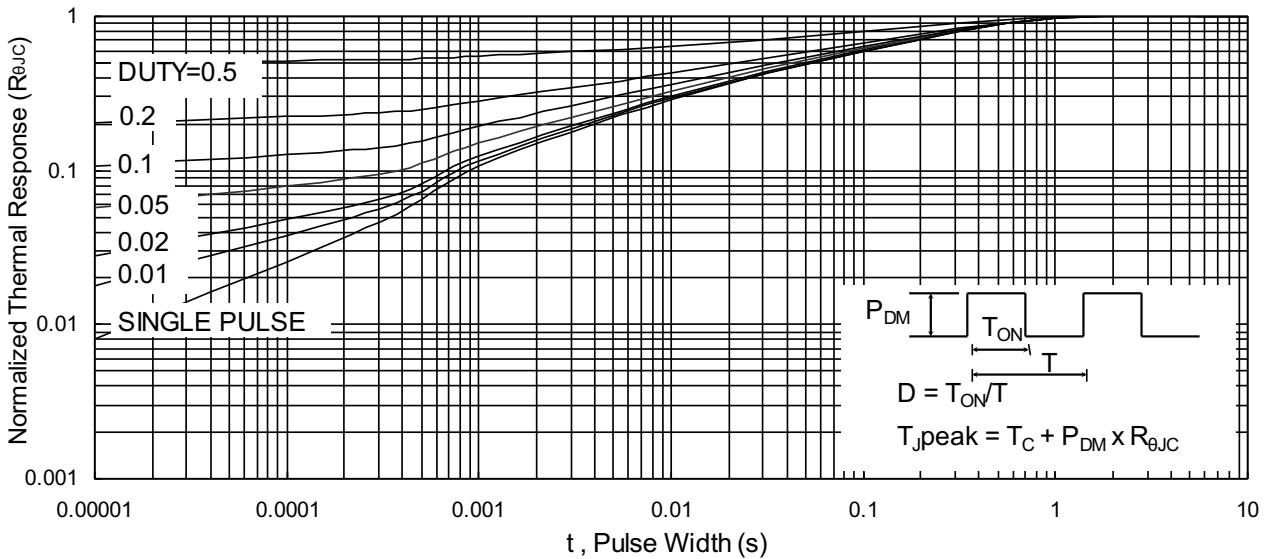

Fig.9 Normalized Maximum Transient Thermal Impedance

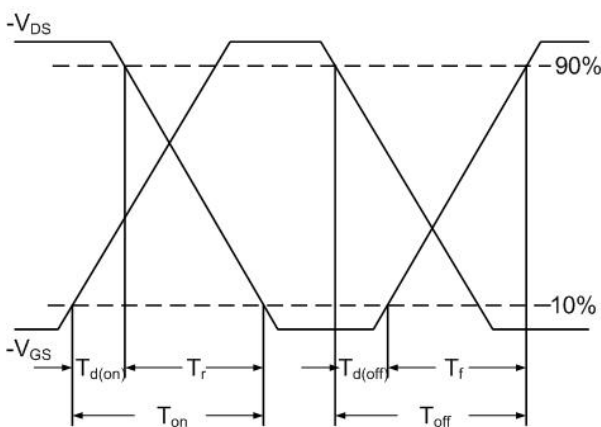

Fig.10 Switching Time Waveform

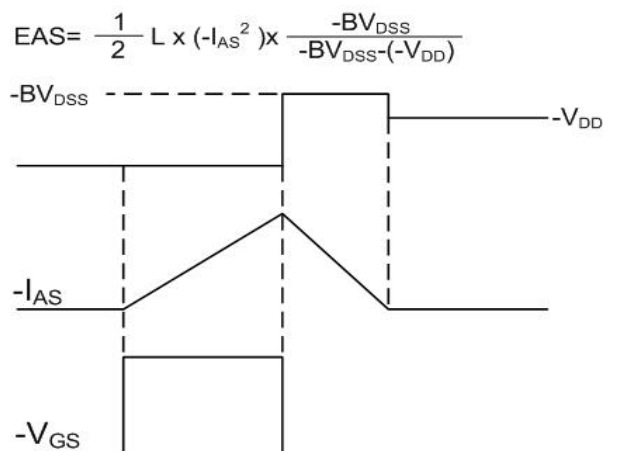

Fig.11 Unclamped Inductive Switching