

SOT-363 Plastic-Encapsulate MOSFETs

CJ3139KDW Dual P-Channel Power MOSFET

$V_{(BR)DSS}$	$R_{DS(on)MAX}$	I_D
-20V	520mΩ@-4.5V	-0.66A
	700mΩ@-2.5V	
	950mΩ(TYP)@-1.8V	

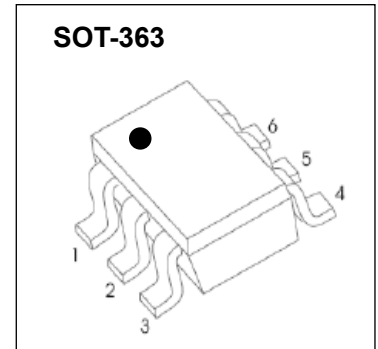

GENERAL DESCRIPTION

This Dual P-Channel MOSFET has been designed using advanced Power Trench process to optimize the $R_{DS(ON)}$.

Including two P-ch CJ3139K MOSFET (independently) in a package.

FEATURE

- High-Side Switching
- Low On-Resistance
- Low Threshold
- Fast Switching Speed

APPLICATION

- Drivers:Relays, Solenoids, Lamps, Hammers, Displays, Memories
- Battery Operated Systems
- Power Supply Converter Circuits
- Load/Power Switching Cell Phones, Pagers

MARKING

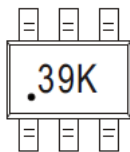

Equivalent Circuit

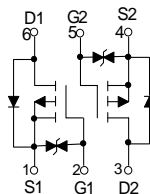

Maximum ratings ($T_a=25^{\circ}C$ unless otherwise noted)

Parameter	Symbol	Value	Unit
Drain-Source voltage	V_{DSS}	-20	V
Typical Gate-Source Voltage	V_{GS}	±12	
Drain Current-Continuous	$I_{D(DC)}$	-0.66	A
Drain Current -Pulsed(note1)	$I_{DM(pulse)}$	-2.64	
Power Dissipation (note 2)	P_D	150	mW
Thermal Resistance from Junction to Ambient	$R_{\theta JA}$	833	$^{\circ}C/W$
Storage Temperature	T_j	150	$^{\circ}C$
Junction Temperature	T_{stg}	-55 ~+150	

MOSFET ELECTRICAL CHARACTERISTICS

$T_a=25^\circ\text{C}$ unless otherwise specified

Parameter	Symbol	Test Condition	Min	Typ	Max	Unit
On/Off States						
Drain-Source Breakdown Voltage	$V_{(BR)DSS}$	$V_{GS} = 0V, I_D = -250\mu A$	-20			V
Gate-Threshold Voltage(note 3)	$V_{GS(th)}$	$V_{DS} = V_{GS}, I_D = -250\mu A$	-0.35	-0.45	-1.1	
Gate-Body Leakage Current	I_{GSS}	$V_{DS} = 0V, V_{GS} = \pm 10V$			± 20	μA
Zero Gate Voltage Drain Current	I_{DSS}	$V_{DS} = -20V, V_{GS} = 0V$			-1	μA
Drain-Source On-State Resistance(note 3)	$R_{DS(on)}$	$V_{GS} = -4.5V, I_D = -1A$		430	520	m Ω
		$V_{GS} = -2.5V, I_D = -800mA$		624	700	
		$V_{GS} = -1.8V, I_D = -500mA$		950		
Forward Transconductance	g_{FS}	$V_{DS} = -10V, I_D = -540mA$	0.8			S
Dynamic Characteristics(note 4)						
Input Capacitance	C_{iss}	$V_{DS} = -16V, V_{GS} = 0V, f = 1MHz$			170	pF
Output Capacitance	C_{oss}				25	
Reverse Transfer Capacitance	C_{rss}				15	
Switching Times (note 4)						
Turn-On Delay Time	$t_{d(on)}$	$V_{DD} = -10V,$ $I_D = -200mA,$ $V_{GS} = -4.5V, R_G = 10\Omega$		9		ns
Rise Time	t_r			5.8		
Turn-Off Delay Time	$t_{d(off)}$			32.7		
Fall Time	t_f			20.3		
Drain-Source Diode Characteristics						
Drain-Source Diode Forward Voltage (note 3)	V_{SD}	$I_S = -0.5A, V_{GS} = 0V$			-1.2	V

Notes:

1. Repetitive Rating: Pulse width limited by maximum junction temperature.
2. This test is performed with no heat sink at $T_a=25^\circ\text{C}$.
3. Pulse Test : Pulse Width $\leq 300\mu s$, Duty Cycle $\leq 0.5\%$.
4. These parameters have no way to verify.

Typical Characteristics

Output Characteristics

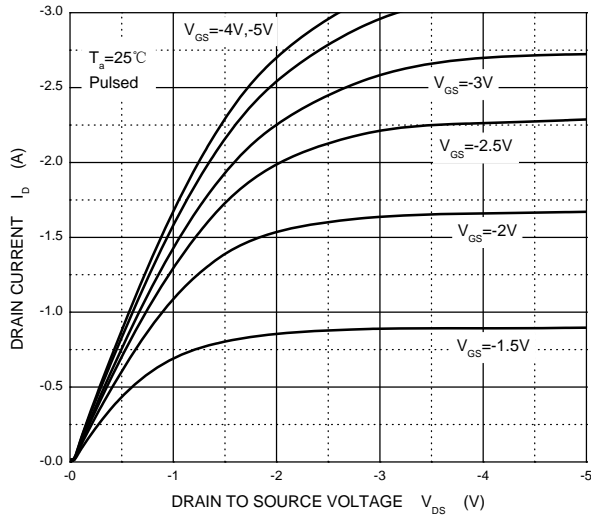

Transfer Characteristics

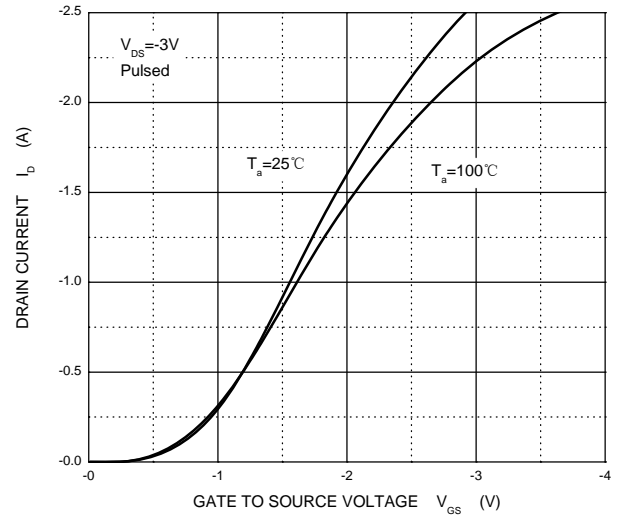

$R_{DS(ON)}$ — I_D

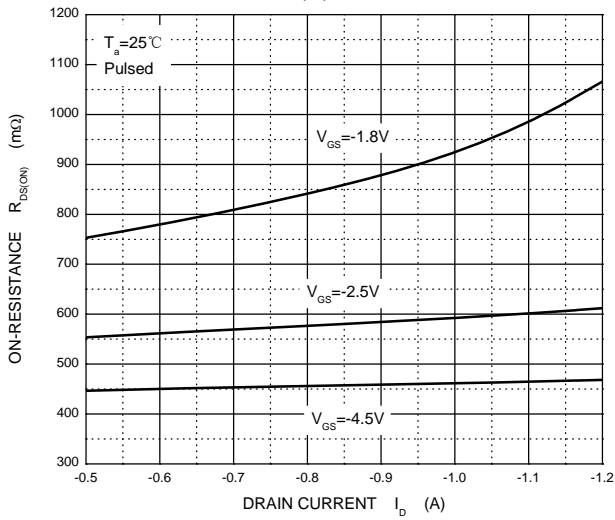

$R_{DS(ON)}$ — V_{GS}

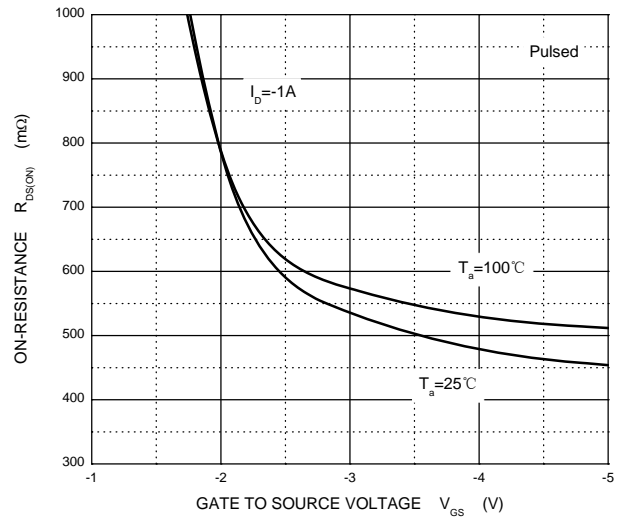

I_S — V_{SD}

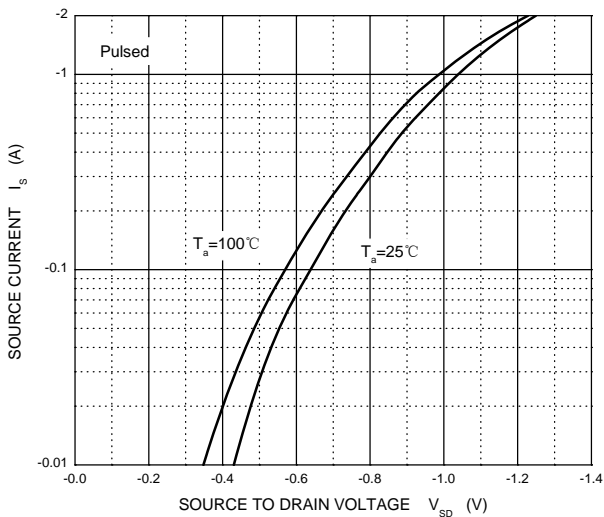

Threshold Voltage

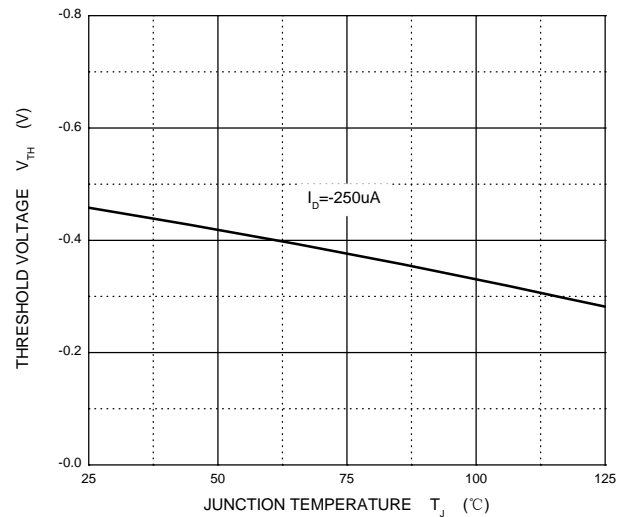

SOT-363 Package Outline Dimensions

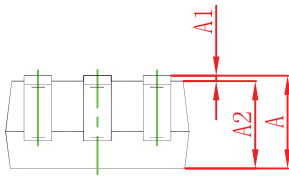
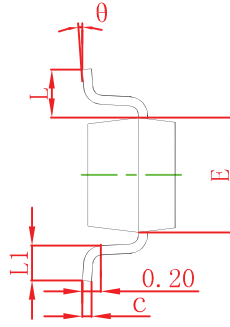
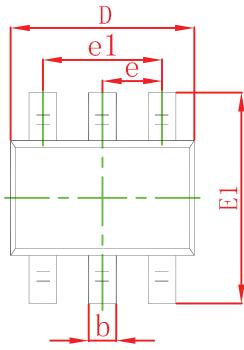

Symbol	Dimensions In Millimeters		Dimensions In Inches	
	Min	Max	Min	Max
A	0.900	1.100	0.035	0.043
A1	0.000	0.100	0.000	0.004
A2	0.900	1.000	0.035	0.039
b	0.150	0.350	0.006	0.014
c	0.100	0.150	0.004	0.006
D	2.000	2.200	0.079	0.087
E	1.150	1.350	0.045	0.053
E1	2.150	2.400	0.085	0.094
e	0.650 TYP		0.026 TYP	
e1	1.200	1.400	0.047	0.055
L	0.525 REF		0.021 REF	
L1	0.260	0.460	0.010	0.018
theta	0°	8°	0°	8°

SOT-363 Suggested Pad Layout

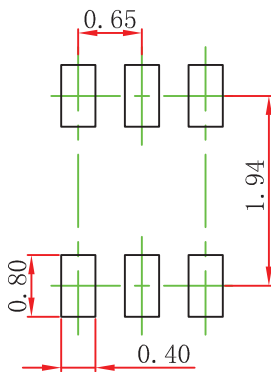

Note:

1. Controlling dimension: in millimeters.
2. General tolerance: $\pm 0.05\text{mm}$.
3. The pad layout is for reference purposes only.

NOTICE

JSCJ reserves the right to make modifications, enhancements, improvements, corrections or other changes without further notice to any product herein. JSCJ does not assume any liability arising out of the application or use of any product described herein.

SOT-363 Tape and Reel

SOT-363 Embossed Carrier Tape

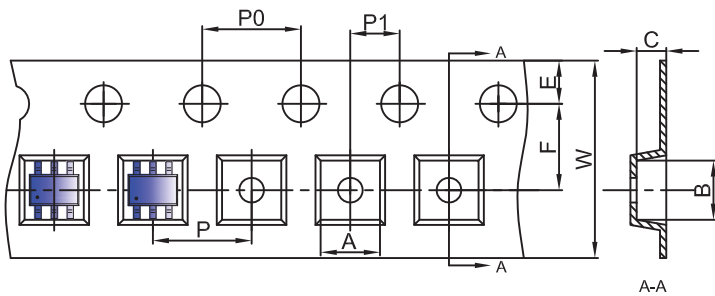

Packaging Description:

SOT-363 parts are shipped in tape. The carrier tape is made from a dissipative (carbon filled) polycarbonate resin. The cover tape is a multilayer film (Heat Activated Adhesive in nature) primarily composed of polyester film, adhesive layer, sealant, and anti-static sprayed agent. These reeled parts in standard option are shipped with 3,000 units per 7" or 17.8cm diameter reel. The reels are clear in color and is made of polystyrene plastic (anti-static coated).

Dimensions are in millimeter										
Pkg type	A	B	C	d	E	F	P0	P	P1	W
SOT-363	2.25	2.55	1.20	Ø1.50	1.75	3.50	4.00	4.00	2.00	8.00

SOT-363 Tape Leader and Trailer

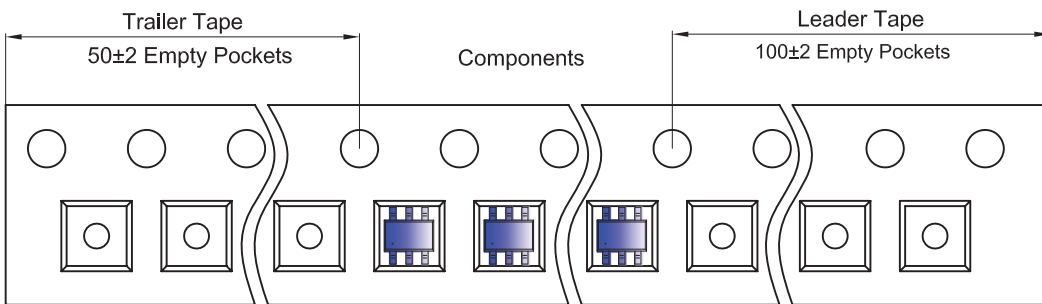

SOT-363 Reel

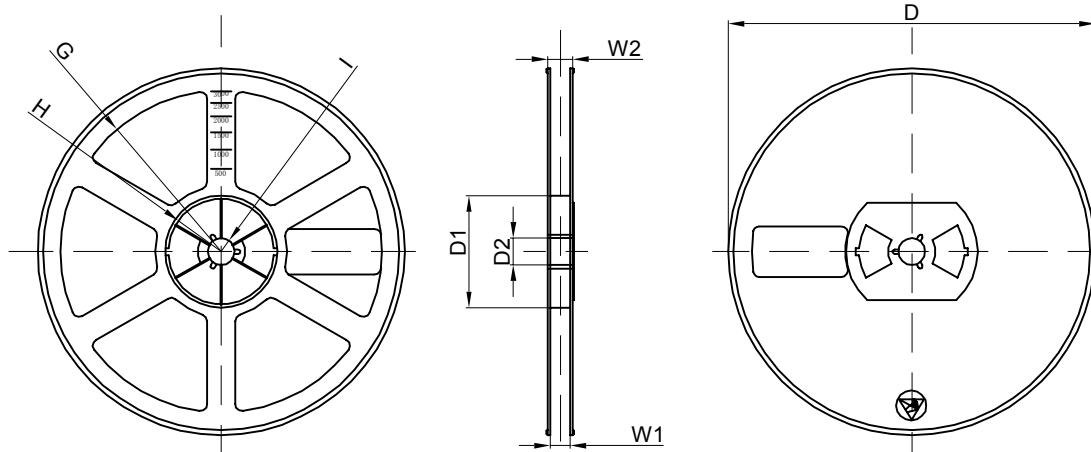

Dimensions are in millimeter								
Reel Option	D	D1	D2	G	H	I	W1	W2
7"Dia	Ø178.00	54.40	13.00	R78.00	R25.60	R6.50	9.50	12.30

REEL	Reel Size	Box	Box Size(mm)	Carton	Carton Size(mm)	G.W.(kg)
3000 pcs	7 inch	45,000 pcs	203×203×195	180,000 pcs	438×438×220	