

## PROTECTION PRODUCTS

### Description

RailClamp® TVS arrays are ultra low capacitance ESD protection devices designed to protect high speed data interfaces. This series has been specifically engineered to protect sensitive components which are connected to high-speed data and transmission lines from overvoltage caused by ESD (electrostatic discharge), CDE (Cable Discharge Events), and EFT (electrical fast transients).

The RClamp®7524T will protect four lines or two differential pairs. Each line has a maximum capacitance of only 0.60pF between any I/O pin and ground.

This allows it to be used on circuits operating in excess of 5GHz without signal attenuation. They feature high maximum ESD withstand voltage of +/- 25kV contact, +/-30kV air discharge per IEC 61000-4-2.

The RClamp7524T is in a 5-pin SLP1308N5T package. It measures 1.3 x 0.8mm with a nominal height of 0.40mm. The innovative flow through package design simplifies PCB layout and allows matched trace lengths for consistent impedance between high speed differential lines. The combination of small size, low capacitance, and high level of ESD protection makes this device a flexible solution for applications such as HDMI, MHL, MDDI, and eDP interfaces.

### Package Dimension

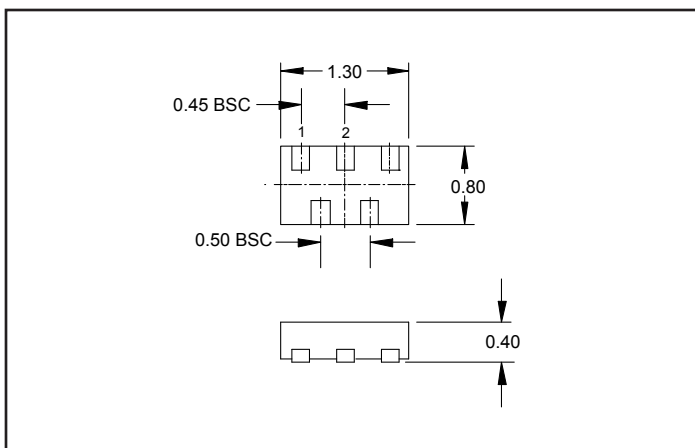

### Features

- ESD protection for high-speed data lines to IEC 61000-4-2 (ESD)  $\pm 30\text{kV}$  (air),  $\pm 25\text{kV}$  (contact)
- IEC 61000-4-5 (Lightning) 5A (8/20 $\mu\text{s}$ )
- IEC 61000-4-4 (EFT) 40A (5/50ns)
- Package design optimized for high speed lines
- Flow-Through design
- Protects four high-speed lines
- Low capacitance: 0.60pF Maximum (I/O to Ground)
- Low ESD clamping voltage
- Low dynamic resistance: 0.50 Ohms (Typ)
- Solid-state silicon-avalanche technology

### Mechanical Characteristics

- SLP1308N5T 5-pin package (1.3 x 0.8 x 0.40mm)
- Pb-Free, Halogen Free, RoHS/WEEE Compliant
- Lead Pitch: 0.45mm
- Lead finish: NiPdAu
- Marking: Marking Code
- Packaging: Tape and Reel

### Applications

- HDMI 1.3 and HDMI 1.4
- V-By-One
- USB 3.0
- MHL
- eDP
- LVDS Interfaces
- eSATA Interfaces

### Schematic & Pin Configuration

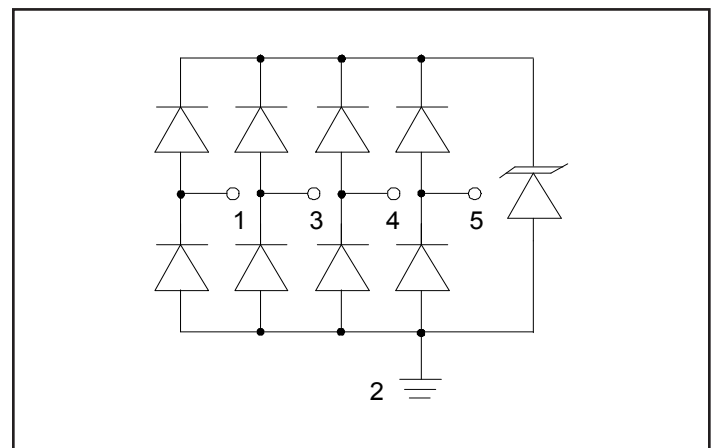

## Absolute Maximum Rating

| Rating   | Symbol           | Value       | Units |
|--|------------------|-------------|-------|
| Peak Pulse Power (tp = 8/20μs)   | P <sub>PK</sub>  | 75          | W     |
| Peak Pulse Current (tp = 8/20μs)   | I <sub>PP</sub>  | 5           | A     |
| ESD per IEC 61000-4-2 (Air) <sup>(1)</sup><br>ESD per IEC 61000-4-2 (Contact) <sup>(1)</sup> | V <sub>ESD</sub> | ±30<br>±25  | kV    |
| Operating Temperature  | T <sub>J</sub>   | -55 to +125 | °C    |
| Storage Temperature  | T <sub>STG</sub> | -55 to +150 | °C    |

## Electrical Characteristics (T=25°C unless otherwise specified)

| Parameter                         | Symbol           | Conditions                            | Min.                   | Typ. | Max. | Units |
|-----------------------------------|------------------|---------------------------------------|------------------------|------|------|-------|
| Reverse Stand-Off Voltage         | V <sub>RWM</sub> | Any I/O to GND                        |                        |      | 5    | V     |
| Reverse Breakdown Voltage         | V <sub>BR</sub>  | I <sub>BR</sub> = 1mA, Any I/O to GND | 6.5                    | 9    | 11   | V     |
| Reverse Leakage Current           | I <sub>R</sub>   | V <sub>RWM</sub> = 5V, Any I/O to GND |                        | 5    | 100  | nA    |
| Clamping Voltage                  | V <sub>C</sub>   | tp = 8/20μs<br>Any I/O to GND         | I <sub>PP</sub> = 1A   |      | 12   | V     |
|                                   |                  |                                       | I <sub>PP</sub> = 5A   |      | 15   |       |
| ESD Clamping Voltage <sup>2</sup> | V <sub>C</sub>   | tp = 0.2/100ns<br>Any I/O to GND      | I <sub>TLP</sub> = 4A  | 11   |      | V     |
|                                   |                  |                                       | I <sub>TLP</sub> = 16A | 17   |      |       |
| Dynamic Resistance <sup>2,3</sup> | R <sub>DYN</sub> | tp = 0.2/100ns                        |                        | 0.5  |      | Ω     |
| Junction Capacitance              | C <sub>J</sub>   | V <sub>R</sub> = 0V, f = 1MHz         | Any I/O to GND         | 0.5  | 0.6  | pF    |
|                                   |                  |                                       | Between I/O pins       | 0.25 | 0.4  |       |

### Notes

- 1) Measured with a 20dB attenuator, 50 Ohm scope input impedance, 2GHz bandwidth. ESD gun return path connected to ESD ground plane.
- 2) Transmission Line Pulse Test (TLP) Settings: tp = 100ns, tr = 0.2ns, I<sub>TLP</sub> and V<sub>TLP</sub> averaging window: t1 = 70ns to t2 = 90ns.
- 3) Dynamic resistance calculated from I<sub>TLP</sub> = 4A to I<sub>TLP</sub> = 16A

# Typical Characteristics

### Non-Repetitive Peak Pulse Power

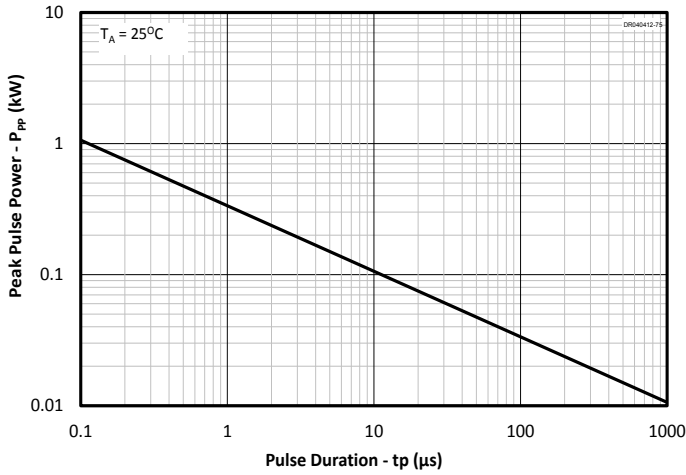

### Power Derating Curve

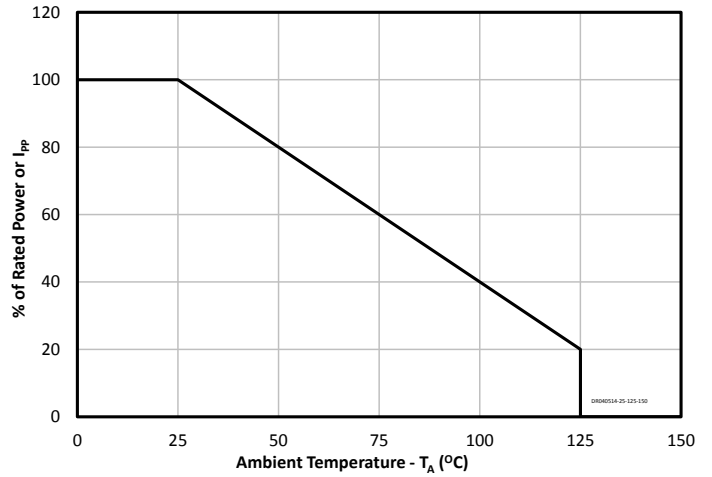

### Clamping Voltage vs. Peak Pulse Current (Between any I/O and Ground)

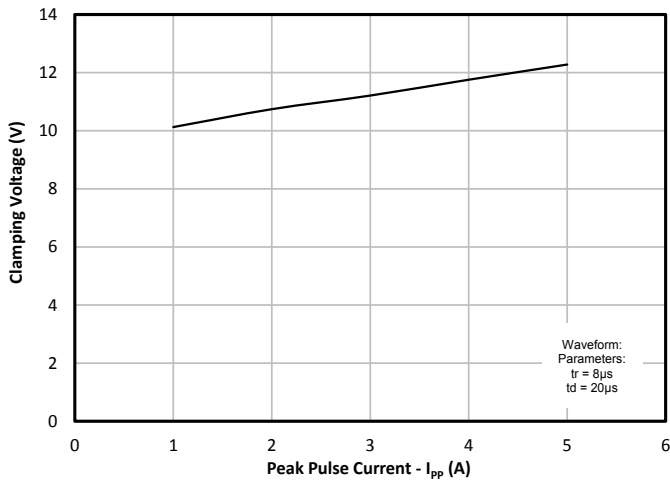

### Junction Capacitance vs. Reverse Voltage (Between any I/O and Ground)

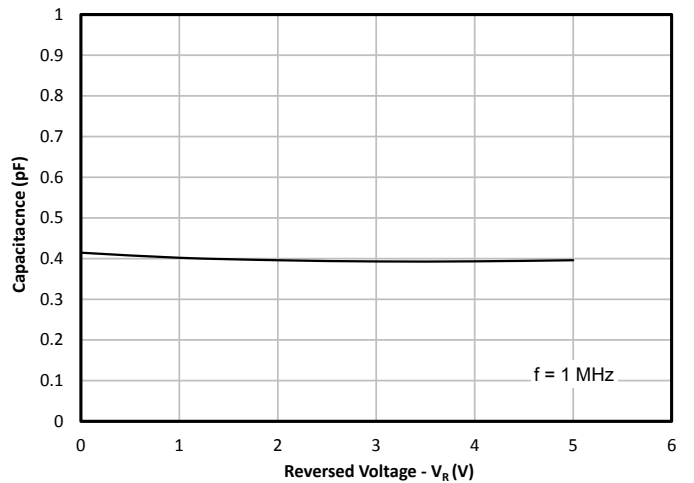

### TLP Characteristic (Positive)

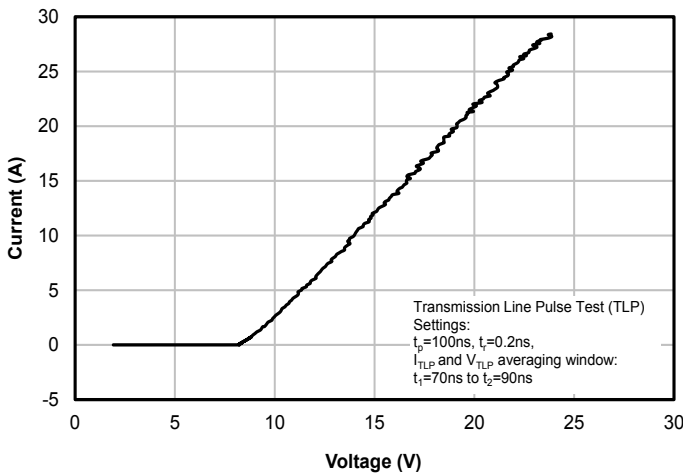

### TLP Characteristic (Negative)

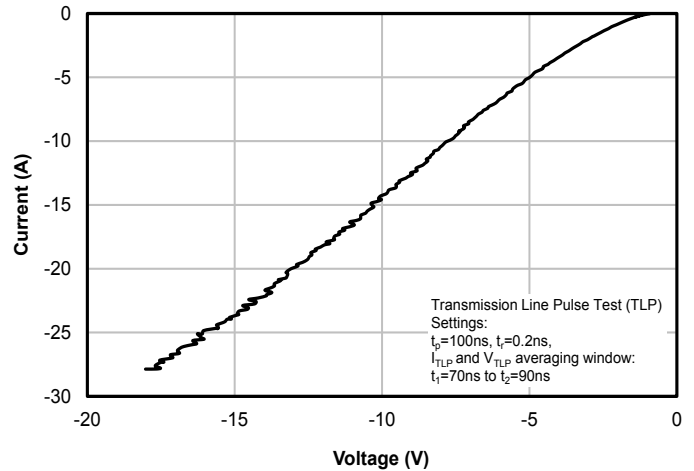

# Typical Characteristics (Continued)

**ESD Clamping (+8kV Contact per IEC 614000-4-2)  
(Between any I/O to Ground)**

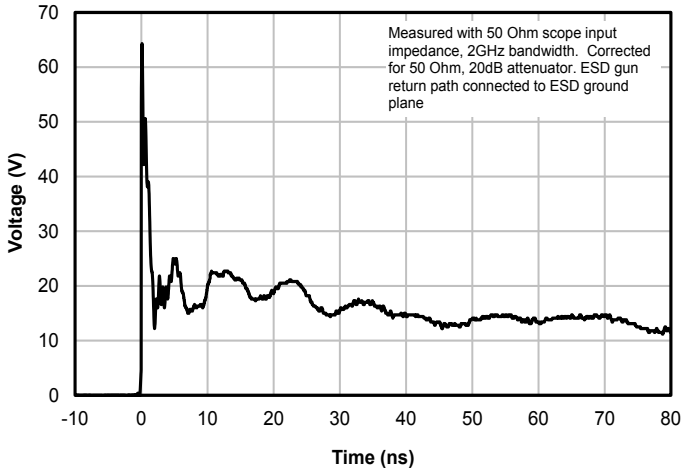

**ESD Clamping (-8kV Contact per IEC 614000-4-2)  
(Between any I/O to Ground)**

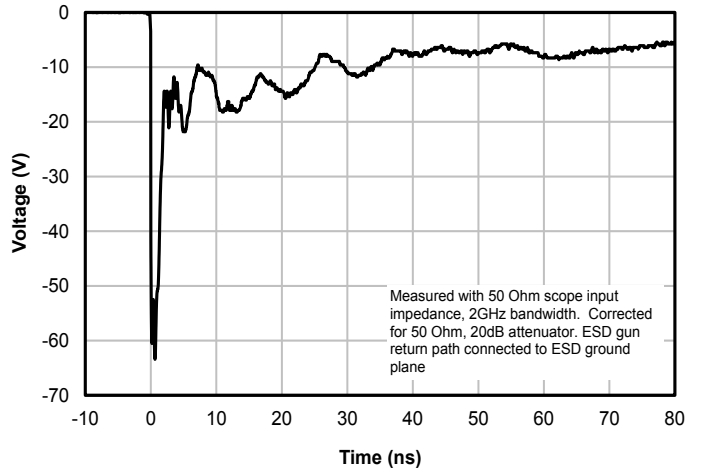

**Typical Insetion Loss S21**

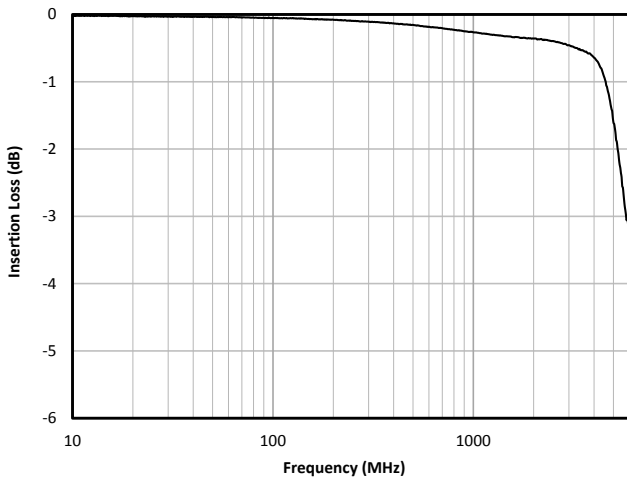

**Analog Crosstalk**

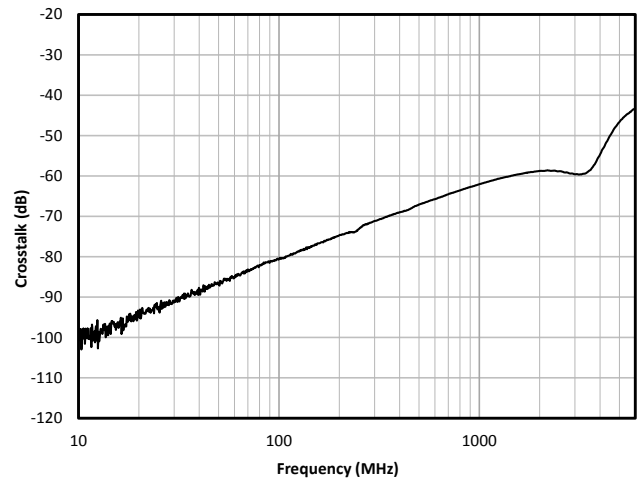



# Application Information

## Assembly Guidelines

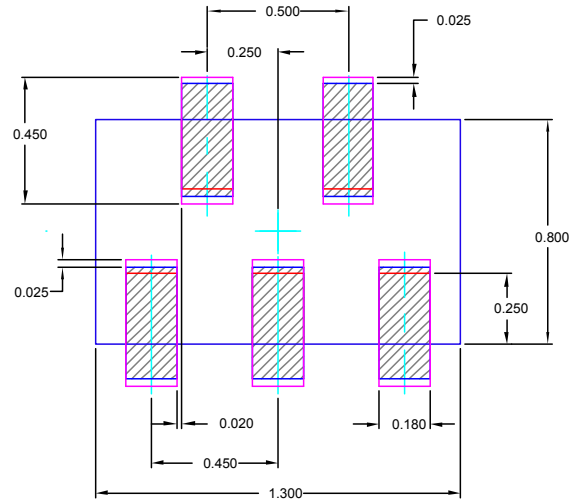
The small size of this device means that some care must be taken during the mounting process to insure reliable solder joint. The table below provides Semtech's recommended assembly guidelines for mounting this device. The figure at the right details Semtech's recommended aperture based on the below recommendations. Note that these are only recommendations and should serve only as a starting point for design since there are many factors that affect the assembly process. The exact manufacturing parameters will require some experimentation to get the desired solder application.



All Dimensions are in mm.

 Land Pad.  Stencil opening  Component

## Recommended Mounting Pattern

| Assembly Parameter       | Recommendation                |
|--------------------------|-------------------------------|
| Solder Stencil Design    | Laser cut, Electro-polished   |
| Aperture shape           | Rectangular                   |
| Solder Stencil Thickness | 0.100 mm (0.004")             |
| Solder Paster Type       | Type 4 size sphere or smaller |
| Solder Reflow Profile    | Per JEDEC J-STD-020           |
| PCB Solder Pad Design    | Non-Solder mask defined       |
| PCB Pad Finish           | OSP Or NiAu                   |

# Application Information

## Application Information

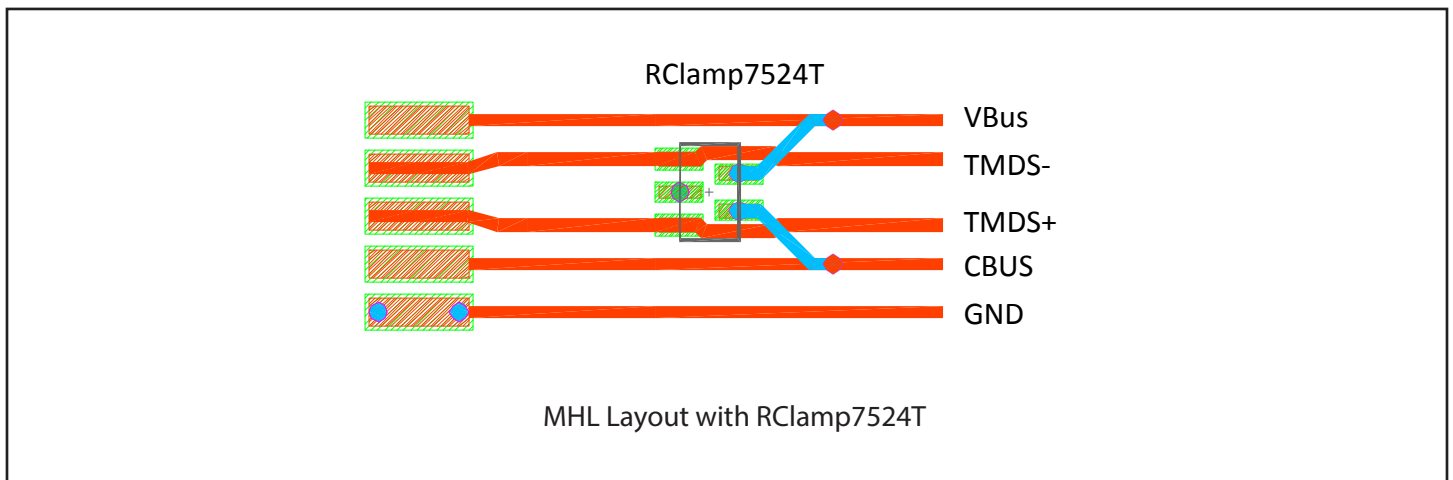
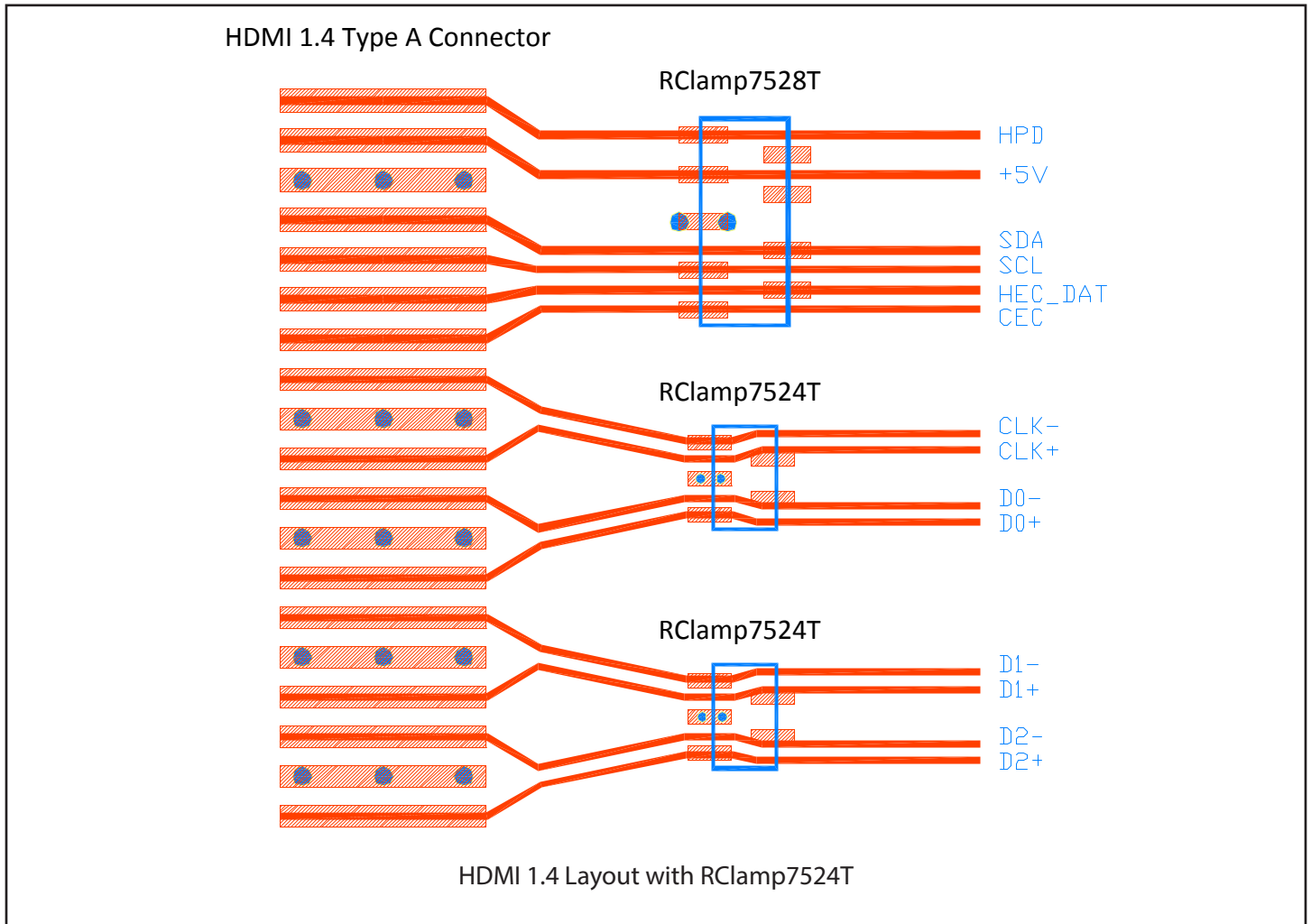

# Outline Drawing - SLP1308N5T

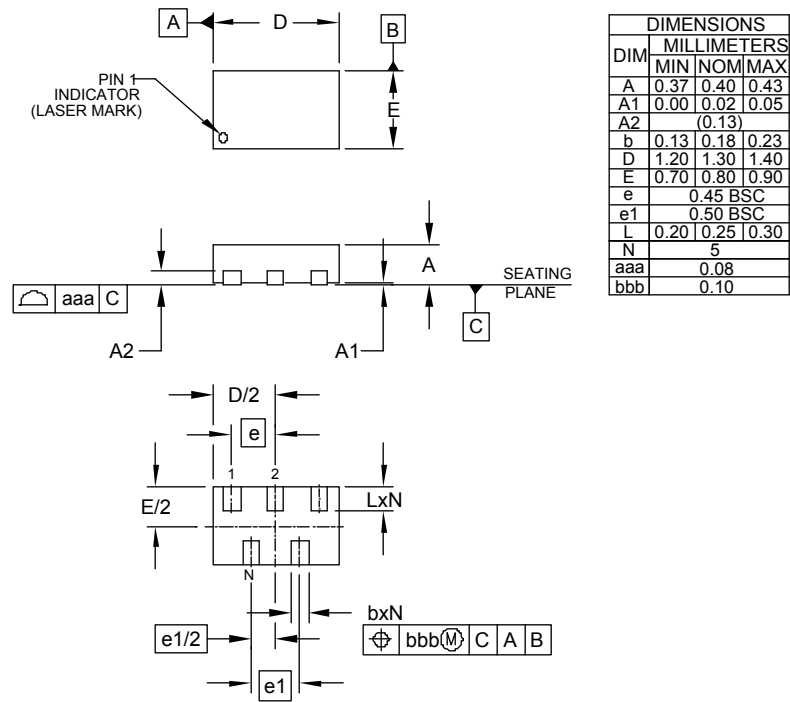

NOTES:  
1. CONTROLLING DIMENSIONS ARE IN MILLIMETERS (ANGLES IN DEGREES).

# Land Pattern - SLP1308N5T

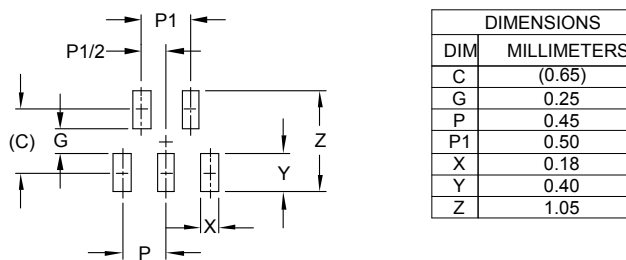

NOTES:  
1. CONTROLLING DIMENSIONS ARE IN MILLIMETERS (ANGLES IN DEGREES).  
2. THIS LAND PATTERN IS FOR REFERENCE PURPOSES ONLY. CONSULT YOUR MANUFACTURING GROUP TO ENSURE YOUR COMPANY'S MANUFACTURING GUIDELINES ARE MET.

## Marking Code

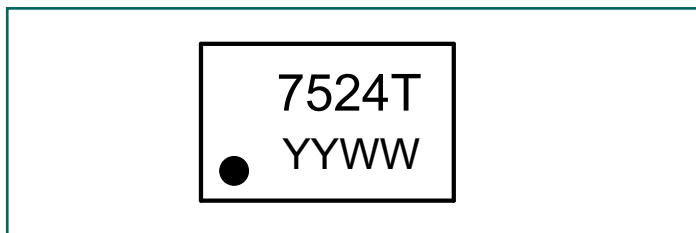

Note: YYWW = Date Code

## Tape and Reel Specification

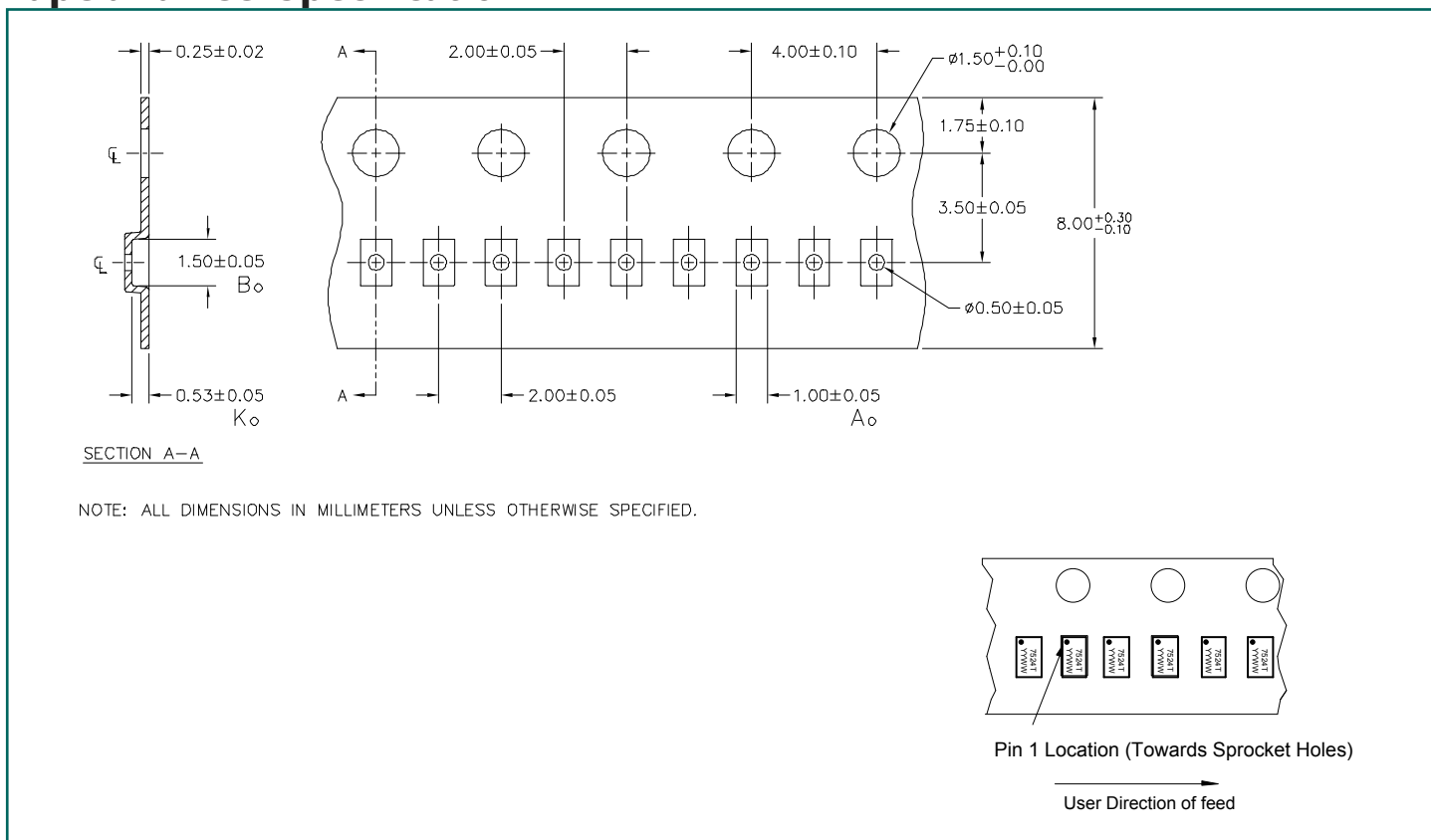

## Ordering Information

| Part Number     | Qty per Reel | Reel Size |
|-----------------|--------------|-----------|
| RClamp7524T.TNT | 10,000       | 7"        |





---

#### IMPORTANT NOTICE

Information relating to this product and the application or design described herein is believed to be reliable, however such information is provided as a guide only and Semtech assumes no liability for any errors in this document, or for the application or design described herein. Semtech reserves the right to make changes to the product or this document at any time without notice. Buyers should obtain the latest relevant information before placing orders and should verify that such information is current and complete. Semtech warrants performance of its products to the specifications applicable at the time of sale, and all sales are made in accordance with Semtech's standard terms and conditions of sale.

SEMTECH PRODUCTS ARE NOT DESIGNED, INTENDED, AUTHORIZED OR WARRANTED TO BE SUITABLE FOR USE IN LIFE-SUPPORT APPLICATIONS, DEVICES OR SYSTEMS, OR IN NUCLEAR APPLICATIONS IN WHICH THE FAILURE COULD BE REASONABLY EXPECTED TO RESULT IN PERSONAL INJURY, LOSS OF LIFE OR SEVERE PROPERTY OR ENVIRONMENTAL DAMAGE. INCLUSION OF SEMTECH PRODUCTS IN SUCH APPLICATIONS IS UNDERSTOOD TO BE UNDERTAKEN SOLELY AT THE CUSTOMER'S OWN RISK. Should a customer purchase or use Semtech products for any such unauthorized application, the customer shall indemnify and hold Semtech and its officers, employees, subsidiaries, affiliates, and distributors harmless against all claims, costs damages and attorney fees which could arise.

The Semtech name and logo are registered trademarks of the Semtech Corporation. All other trademarks and trade names mentioned may be marks and names of Semtech or their respective companies. Semtech reserves the right to make changes to, or discontinue any products described in this document without further notice. Semtech makes no warranty, representation or guarantee, express or implied, regarding the suitability of its products for any particular purpose. All rights reserved.

© Semtech 2015

---

#### Contact Information

Semtech Corporation  
200 Flynn Road, Camarillo, CA 93012  
Phone: (805) 498-2111, Fax: (805) 498-3804  
[www.semtech.com](http://www.semtech.com)