



TAI-SAW TECHNOLOGY CO., LTD.

No. 3, Industrial 2nd Rd., Ping-Chen Industrial District,
Taoyuan, 324, Taiwan, R.O.C.

TEL: 886-3-4690038 FAX: 886-3-4697532
E-mail: tstsales@mail.taisaw.com Web: www.taisaw.com

Product Specifications Approval Sheet

Product Description: Crystal Unit SMD 2.0x1.6 24.0MHz

TST Part No.: TZ1620C

Customer Part No.: _____

Customer signature required
Company: _____
Division: _____
Approved by : _____
Date: _____

Checked by: _____ Chia Huar Rau *CH*

Approved by: _____ Kelly Huang *Kelly Huang*

Date: _____ 09/01/2016

1. Customer signed back is required before TST can proceed with sample build and receive orders.
2. Orders received without customer signed back will be regarded as agreement on the specifications.
3. Any specifications changes must be approved upon by both parties and a new revision of specifications shall be released to reflect the changes.



TAI-SAW TECHNOLOGY CO., LTD.
Crystal Unit SMD 2.0x1.6 24.0MHz

MODEL NO.: TZ1620C

REV. NO.: 3.0

Revise:

Rev.	Rev. Page	Rev. Account	Date	Ref. No.	Revised by
1	N/A	Initial release	01/31/13	N/A	Stephen Wei
2	P4	Change Base drawing	06/23/16'	ECN-201600209	Chia Haur Rau
3	P4	Change Base drawing	09/01/16'	ECN-201600340	Chia Haur Rau



TAI-SAW TECHNOLOGY CO., LTD.

Crystal Unit SMD 2.0x1.6 24.0MHz

MODEL NO.: TZ1620C

REV. NO.: 3.0

Features:

- Surface Mount Hermetic Package
- Excellent Reliability Performance
- Good Frequency Perturbation and Stability over temperature
- Ultra Miniature Package

RoHS Compliant
Lead free
Lead-free soldering

Description and Applications:

Surface mount 2.0mmx1.6mm crystal unit for use in wireless communications devices, especially for a need of ultra miniature package for mobility.

Electrical Specifications:

TZ1620C	Specification
Nominal Frequency	24.000000 MHz
Mode of Oscillation	Fundamental
Storage Temperature Range	-40°C to +90°C
Operating Temperature Range	-20°C to +75°C
Frequency Stability over Operating Temperature Range	+/-10 ppm (referred to the value at 25°C)
Frequency Make Tolerance (FL)	+/-10 ppm @ 25°C +/- 3°C
Equivalent Series Resistance (ESR)	60 Ω max
Nominal Drive Level	10uW typical and 100uW max
Shunt Capacitance (Co)	5.0 pF max
Load Capacitance (CL)	9 pF
Insulation Resistance	500 MΩ min./DC 100V
Marking	Laser Marking
Unit Weight	5.7mg+/-0.5mg

Mechanical Dimensions (mm): Base1

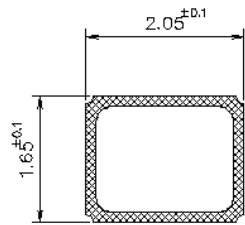

Internal Connections
(Top View)

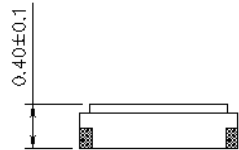
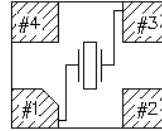

[NOTE] #2, #4 is connected with a metal cover

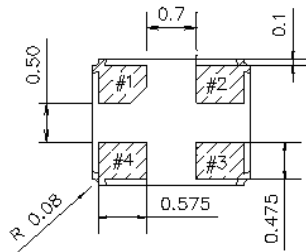

	Pin Connection
#1 pin	IN/OUT
#2 pin	GND
#3 pin	IN/OUT
#4 pin	GND

Base2

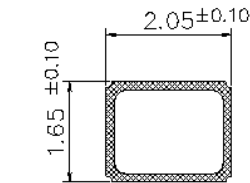

Internal Connections
(Top View)

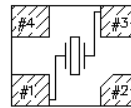

[NOTE] #2, #4 is connected with a metal cover

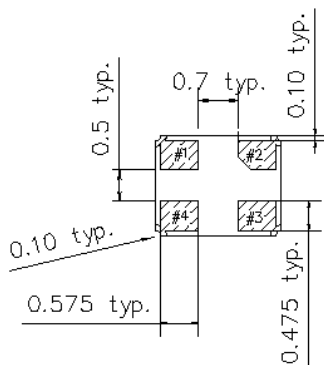

	Pin connection
#1 Pin	IN/OUT
#2 Pin	GND
#3 Pin	IN/OUT
#4 Pin	GND

Recommended Land Pattern: (unit: mm)

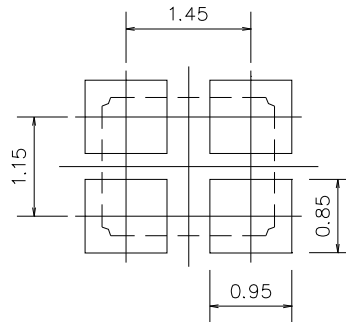

Recommended Land Pattern

Marking:

Line 1: XX; Frequency (24)

Line 2: T; Traceable Code + D; date Code of Year/Month

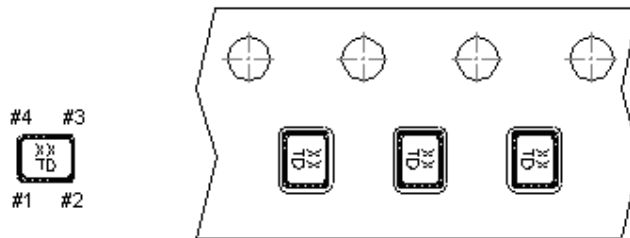

Date Code Table: Year/Month

Year/Month	1	2	3	4	5	6	7	8	9	10	11	12
2012	a	b	c	d	e	f	g	h	i	j	k	m
2013	n	p	q	r	s	t	u	v	w	x	y	z
2014	A	B	C	D	E	F	G	H	J	K	L	M
2015	N	P	Q	R	S	T	U	V	W	X	Y	Z
2016	a	b	c	d	e	f	g	h	i	j	k	m
2017	n	p	q	r	s	t	u	v	w	x	y	z
2018	A	B	C	D	E	F	G	H	J	K	L	M
2019	N	P	Q	R	S	T	U	V	W	X	Y	Z
2020	a	b	c	d	e	f	g	h	i	j	k	m
2021	n	p	q	r	s	t	u	v	w	x	y	z
2022	A	B	C	D	E	F	G	H	J	K	L	M
2023	N	P	Q	R	S	T	U	V	W	X	Y	Z
2024	a	b	c	d	e	f	g	h	i	j	k	m
2025	n	p	q	r	s	t	u	v	w	x	y	z

Packing Quantity/Packing:

3K pcs maximum per reel

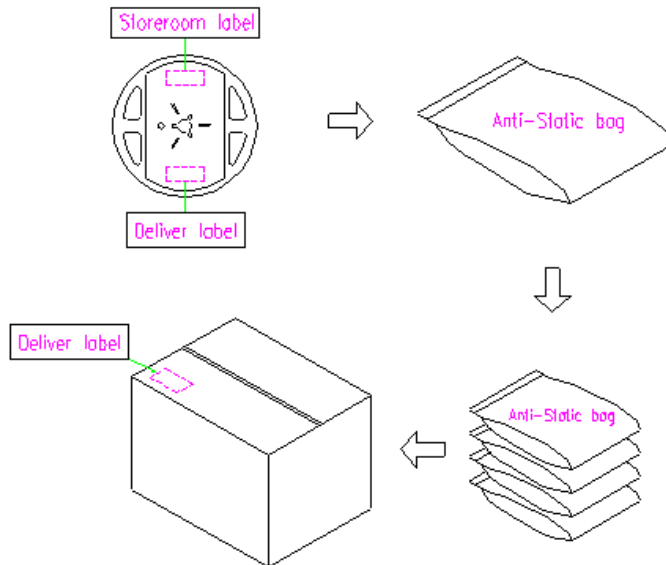

Reflow Profile:

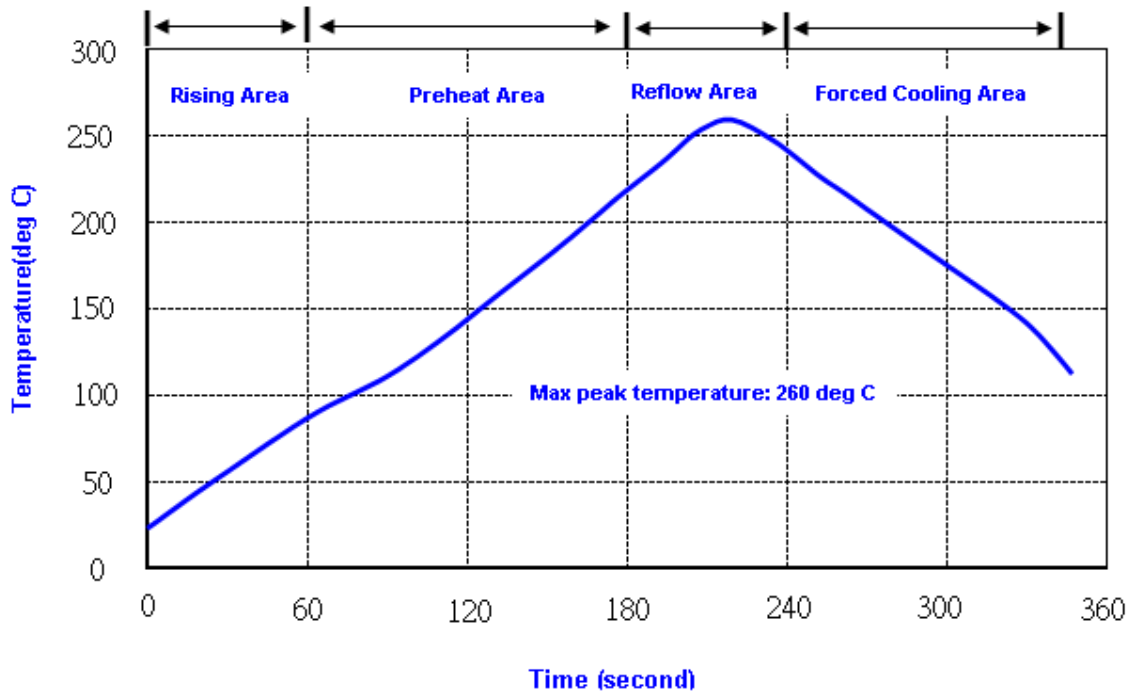

- Note:**
1. Max peak temperature: 260 \pm 5 deg C; Time: 10 \pm 2 sec
 2. Temperature: 217 \pm 5 deg C; Time: 90~100 sec

Reliability Specifications

Test name	Test process / method	Reference standard
Mechanical characteristics		
resistance to Soldering heat (IR reflow)	Temp./ Duration : 265°C /10sec ×2 times Total time : 4min.(IR-reflow)	EIAJED-4701 -300(301)M(II)
Vibration	Total peak amplitude : 1.5mm Vibration frequency : 10 to 2000 Hz Sweep period : 20 minute Vibration directions : 3 mutually perpendicular Duration : 2 hr / direc.	MIL-STD 202G method 204
Mechanical Shock	directions : 3 impacts per axis Acceleration : 3000g's, +20/-0 % Duration : 0.3 ms (total 18 shocks) Waveform : Half-sine	MIL-STD 202G method 213
Solderability	Solder Temperature: 265±5°C Duration time: 5±0.5 seconds.	J-STD-002
Environmental characteristics		
Thermal Shock	Heat cycle conditions -40 °C (30min) ↔ 85 °C (30min) * cycle time : 10 times	MIL-STD 883G method 1010.8
Humidity test	Temperature : 85 ± 2 °C Relative humidity : 85% Duration : 96 hours	MIL-STD 202G method 103
Dry heat (Aging test)	Temperature : 125 ± 2 °C Duration : 168 hours	MIL-STD 202G method 108A
Cold resistance (Low Temp Storage)	Temperature : -40 ± 2 °C Duration : 96 hours	IEC 60068-2-1