

Green-Mode PWM Controller with Hiccup Protection

Features

- Current Mode Control
- Standby Power below 75mW
- Under-Voltage Lockout (UVLO)
- Non-Audible-Noise Green-Mode Control
- 65KHz Switching Frequency
- Internal Leading-Edge Blanking
- Internal Slope Compensation
- Internal Soft Start
- Gate Output Voltage Clamp
- Jitter and Soft Driving for Reducing EMI
- External OVP Auto Recovery Mode
- External OTP Auto Recovery Mode
- Over-Load Protection (OLP) -Auto Recovery Mode
- Vcc OVP Protection- Auto Recovery Mode
- 300mA Driving Capability

Description

The GR1837 is a highly-integrated, low startup current, current mode PWM controller with green-mode function. The integrated functions also include the leading-edge blanking of the current sensing, internal slope compensation, soft start OLP, and OCP. Besides, The RTL pin Auto recovery function by injecting a high over 3.5V to provide OVP Auto recovery and low below 1V to provide OTP Auto recovery protection. These functions enable the power supply to easily meet even the strictest power requirements.

The GR1837 improves the performance and reduces the cost of power supplies. It is with 8-pin DIP and 6-pin SOT-26 package.

Application

- Battery Charger
- Open Frame SMPS
- Switching AC/DC Adapter

Ordering and Marking Information

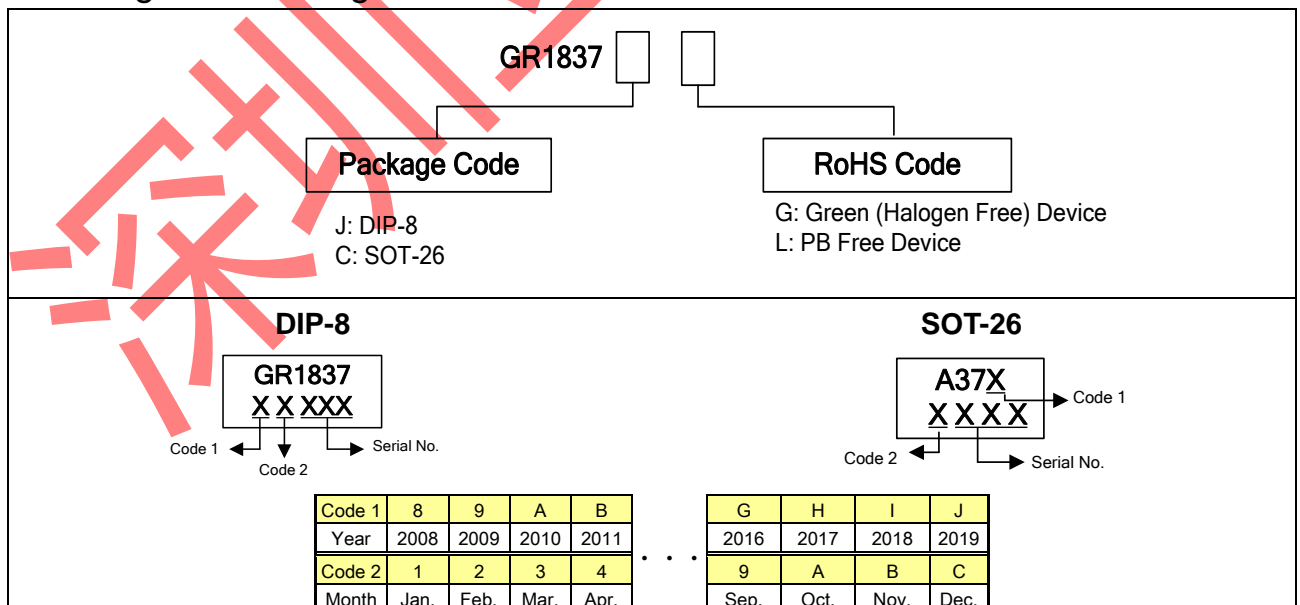

Nanjing Greenchip Semiconductor Co., Ltd. (Greenergy OPTO Inc.) reserves the right to make changes to improve reliability or manufacture ability without notice, and advise customers to obtain the latest version of relevant information to verify before placing orders.

Pin Configuration

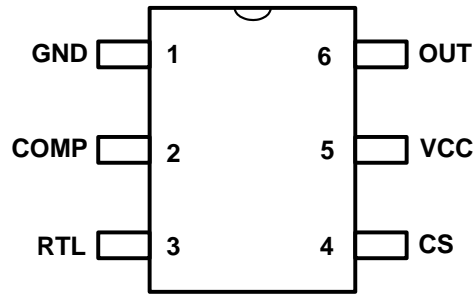

Pin Description

Pin No.	Name	Function
1	GND	Ground pin
2	COMP	Voltage feedback pin, by connecting a photo-coupler to control the duty cycle
3	RTL	Resistor trigger will enter auto recovery mode which a high over 3.5V for OVP auto recovery and a low below 1V for OTP auto recovery
4	CS	Current sense pin, connect to sense the MOSFET current
5	VCC	Power supply pin
6	OUT	The output driver for driving the external MOSFET

Absolute Maximum Ratings

Supply voltage VCC	-----	30V
COMP, RTL, CS	-----	-0.3 ~ 7V
OUT	-----	-0.3 ~ VCC + 0.3V
Junction temperature	-----	150°C
Operating ambient temperature	-----	-20°C ~ 85°C
Storage temperature range	-----	-65°C ~ 150 °C
SOT-26 package thermal resistance (junction to ambient)	-----	250°C/W
Power dissipation (SOT-26, at ambient temperature = 85°C)	-----	250mW
Power dissipation (DIP-8, at ambient temperature = 85°C)	-----	650mW
Lead temperature (All Pb free packages, soldering, 10 sec)	-----	260°C
ESD voltage protection, human body model	-----	2KV
ESD voltage protection, machine model	-----	200V

Electrical Characteristics (VCC = 15.0V & TA = +25°C, unless otherwise specified.)

Parameter	Pin	Min.	Typ.	Max.	Unit
SUPPLY VOLTAGE					
Startup current (VCC=UVLO on -0.1V)	5		8	15	uA
Operating current (with 1nF load on OUT pin), Vcomp = 0V	5		800		uA
Operating current (with 1nF load on OUT pin), Vcomp = 2.5V	5	1	2	3	mA
Operating current (with 1nF load on OUT pin), protection tripped (OLP, OVP)	5	0.4	0.7	1	mA
UVLO(off)	5	6.2	6.8	7.4	V
UVLO(on)	5	10.6	11.3	12.0	V
OVP level on VCC pin-latch Mode	5	27	28	29	V
VOLTAGE FEEDBACK					
Short circuit current, Vcomp = 0V	2	0.2			mA
Open loop voltage, COMP pin open	2	4.4		5.5	V
Green-mode start voltage	2		1.85		V
Green mode threshold voltage	2		1.4		V
Burst mode start voltage	2		0.85		V
CURRENT SENSING					
Maximum input voltage at Low Line, Vcsmax	4	0.80	0.85	0.9	V
Maximum input voltage at High Line, VcsmaxL (Duty=0%)	4		0.60		V
Leading-Edge Blanking Time	4		500		nS
Input impedance	4	1			MΩ
Delay to Output	4		100		nS
OSCILLATOR					
Frequency	-	60	65	70	KHz
Jitter frequency	-		±6		%
Green mode Minimum frequency	-	21	23	25	KHz
Temp. stability (-40°C ~ 110°C)	-			5	%
Voltage stability (VCC = 11V~25V)	-			3	%
GATE DRIVER OUTPUT					
Output low level, VCC = 15V, Io = 20mA	6			1	V
Output high level, VCC = 15V, Io = 20mA	6	8			V
Rising time, load capacitance = 1000pF	6		320		nS
Falling time, load capacitance = 1000pF	6		80		nS
VGATE-clamp (VCC = 25V)	6	12	13		V
OLP SECTION					
OLP trip level, Vcomp (OLP)	-		3.5		V
OLP delay time	-		60		mS

PWM SECTION

Maximum duty cycle	-	70	75	80	%
--------------------	---	----	----	----	---

RTL SECTION

Over Voltage Protection threshold voltage	3	3.2	3.5	3.8	V
OVP Debounce time	3		100		uS
Over Temperature Protection threshold voltage	3	0.95	1	1.05	V
OTP Debounce time	3		100		us
Output current from RTL pin	3	75	80	85	uA
RTL Pin voltage when floating	3	1.8	2.4	3.0	V

仅供内部使用 ONLY

Typical Performance Characteristics

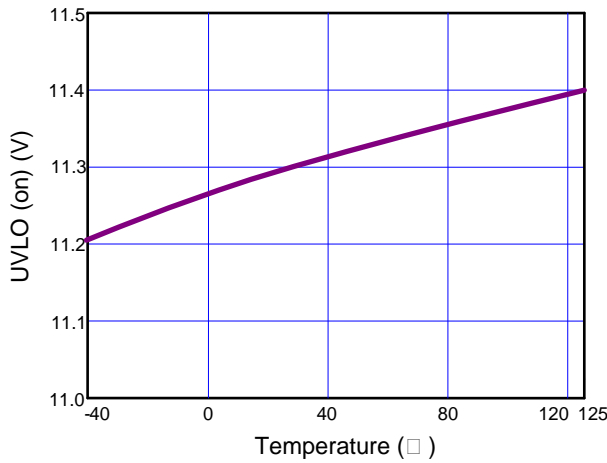

Fig. 1 UVLO (on) vs. Temperature

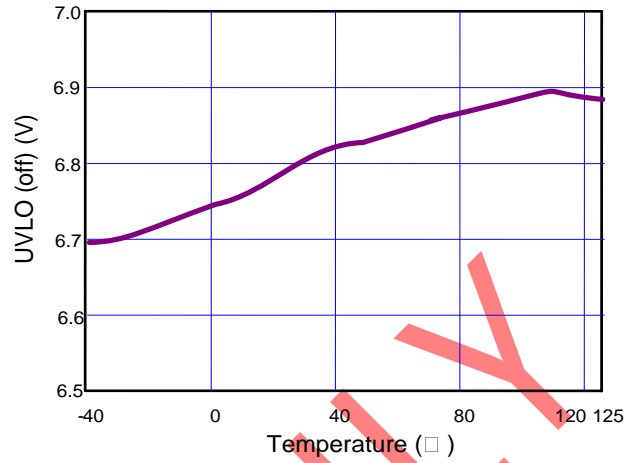

Fig. 2 UVLO (off) vs. Temperature

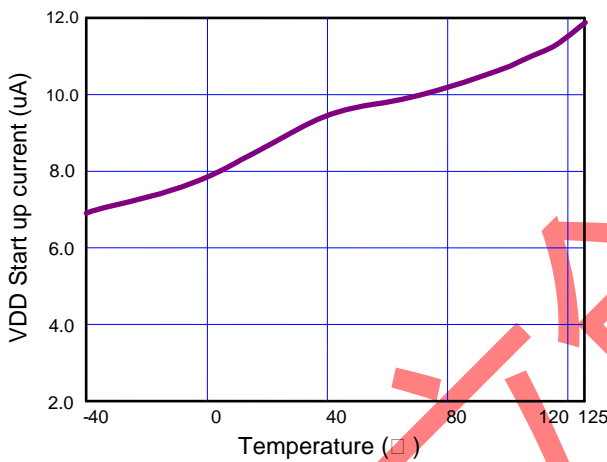

Fig. 3 VDD Start up current vs. Temperature

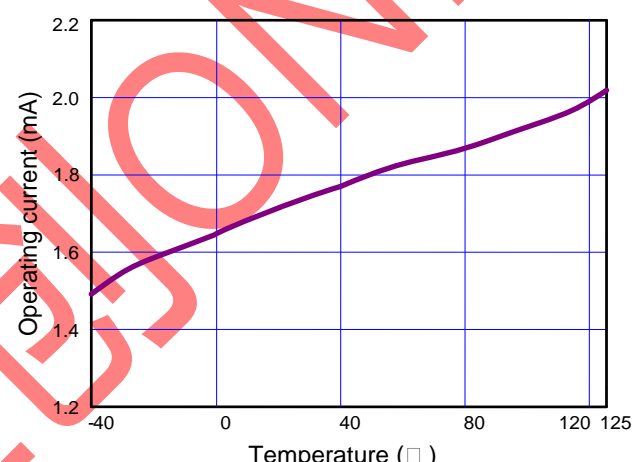

Fig. 4 Operating current vs. Temperature

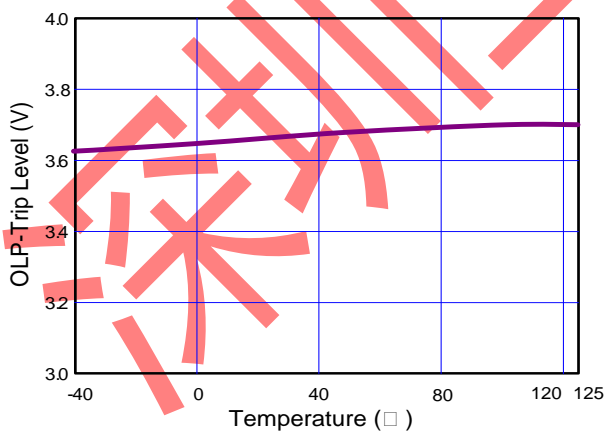

Fig. 5 OLP Trip Level vs. Temperature

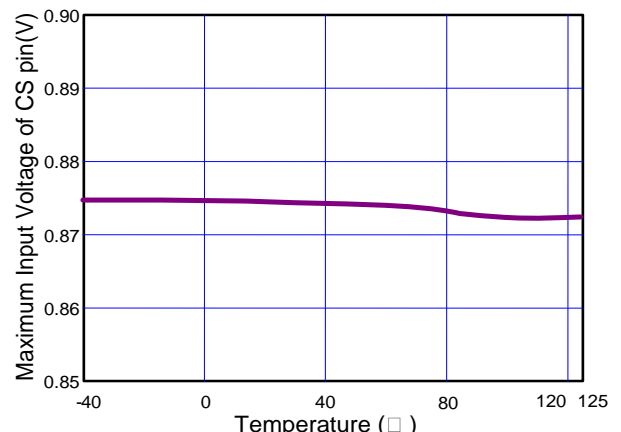

Fig. 6 Maximum Input Voltage of CS pin vs. Temperature

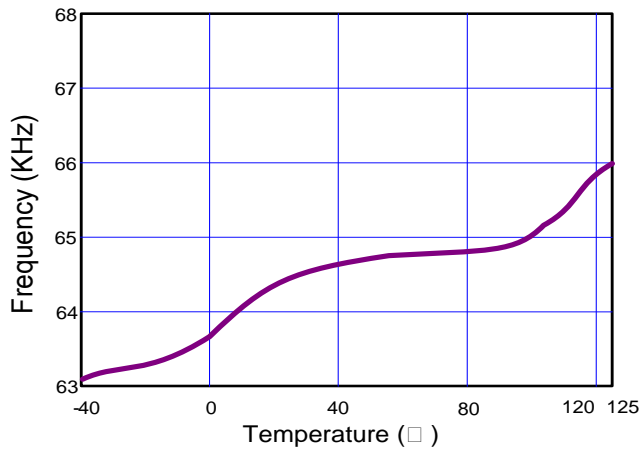

Fig. 7 Frequency vs. Temperature

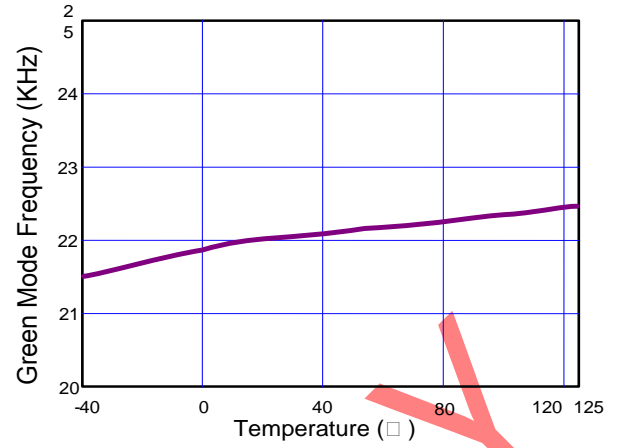

Fig. 8 Green Mode Frequency vs. Temperature

仅供内部参考

Application Information

Start-up Current

The typical start-up current is around 8uA. Very low start-up current allows the PWM controller to increase the value of start-up resistor and then reduce the power dissipation on it.

UVLO (Under Voltage Lockout)

A hysteresis UVLO comparator is implemented in GR1837. Then turn-on and turn-off thresholds level are fixed at 11.3V and 6.8V respectively. This hysteresis shown in Fig.9 ensures that the start-up capacitor will be adequate to supply the chip during start-up. The GR1837 is designed to meet the standby power below 75mW. So the start-up resistor can be used as several Mega Ohms to reduce the power loss. Due to the low UVLO on level, so the turn-on delay time will be also never greater than the general PWM IC.

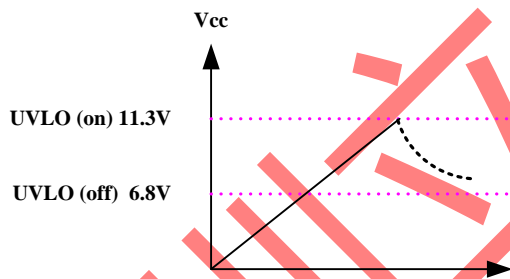

Fig.9

Soft Start

During initial power on, the GR1837 provides 16ms soft start function. It effectively suppresses the start up peak current to reduce the power MOSFET drain voltage especially at high line.

Oscillator

The maximum duty-cycle of internal oscillator is limited to 75% for avoiding the transformer saturation. The frequency of the oscillator is fixed to 65KHz by internal setting.

Green-Mode Operation

When the load decreases to an extent, the frequency of the controller will decrease so as to reduce the system power consumption. The minimum frequency is about 22 KHz, which is outside the audio range.

LEB (Leading-Edge Blanking)

Each time the power MOSFET is switched on, a turn-on spike will inevitably occur at the sense resistor. To avoid fault trigger, a 500ns leading-edge blanking time is built in. During this blanking period, the current-limit comparator is disabled and can not switch off the gate driver.

Internal Slope Compensation

Built-in slope compensation circuit adds voltage ramp in the current sense input voltage for PWM generation. This greatly improves the close loop stability at CCM and prevents the sub-harmonic oscillation and thus reduces the output ripple voltage.

OLP (Over Load Protection)

The GR1837 has over load protection function. An internal circuit detects the load level, when the load is larger than a threshold level and the condition lasts more than 60ms, the gate output will keep on low level. Then VCC decreases below UVLO off level, the controller resets again. Fig.10 shows the waveform of the OLP operation.

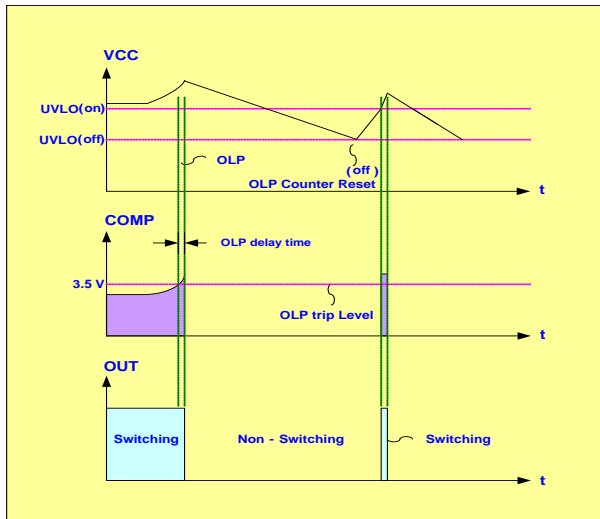

Fig. 10

OVP (Over Voltage Protection) on VCC

To prevent power MOSFET from being damaged, the GR1837 is implemented an OVP function on VCC. When the VCC voltage is higher than the OVP threshold voltage, the output gate driver circuit will be shut down immediately to stop the switching of power MOSFET. The VCC pin OVP function is an Auto-recovery type protection. GR1837 is working in Auto-recovery mode as shown in Fig. 11.

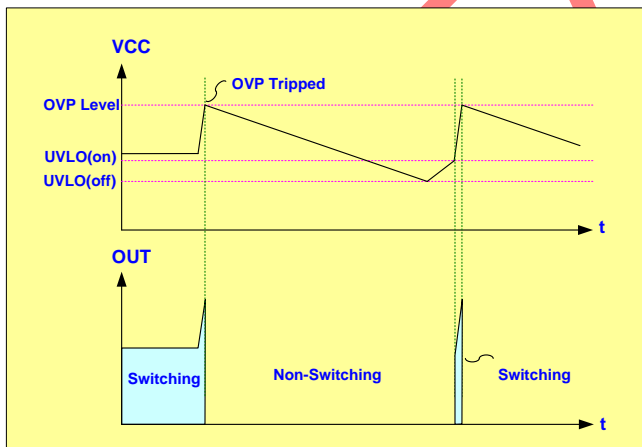

Fig. 11

Gate Clamp/Soft Driving

Driver is clamped to 13V by an internal clamping circuit. A totem pole gate driver is fine tuned to meet both EMI and efficiency requirement in low power application. An internal pull low circuit is activated after pretty low V_{dd} to prevent external MOSFET from accidentally turning on during UVLO.

VCC Mode Operation

In order to avoid the output voltage shut down by load changing from full to no load, the GR1837 is built-in the VCC mode function. When the load from full changes to no load, the output voltage will overshoot and pull low the COMP pin by feedback loop. Thus the duty will disappear and no power delivers to the secondary. If there is without any mechanism to prevent this situation, the VCC pin voltage will down to UVLO off and the IC will re-start again. In the GR1837, before the VCC is down to UVLO off, it will force the OUT pin outputs the specified duty to pull the VCC higher than UVLO off. The operation is shown in Fig.12.

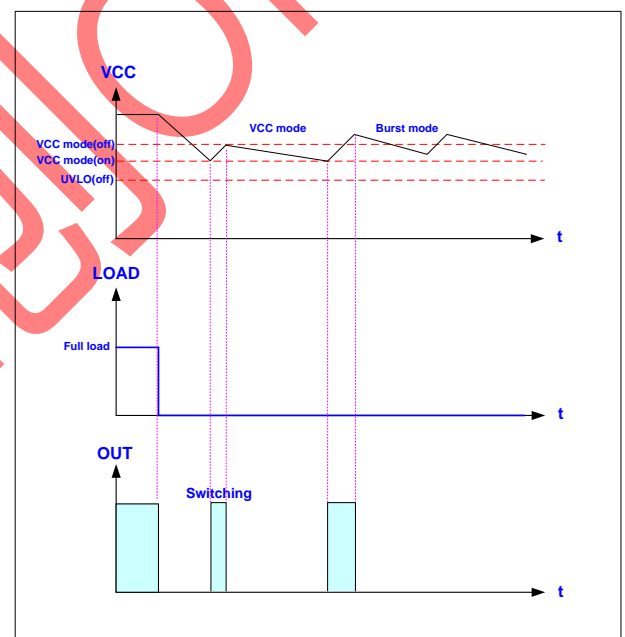

Fig. 12

The VCC mode function is used to prevent the output re-start again when load changes. So never let the system operate on the VCC mode at no load. The system should operate on burst mode, otherwise the input power maybe become larger.

RTL Pin Auto-Recovery Mode

Fig. 13

The typical application for RTL pin is shown in Fig. 13. The Zener diode is setting as external OVP protection and the NTC thermal resistor is setting as external OTP protection. In the RTL pin, there are two comparators for Auto-recovery protection. While the voltage on this pin is higher than 3.5V or lower than 1.0V, the GR1837 will enter Auto-recovery protection after the de-bounce time 100us.

Application Circuit

1. Typical Circuit

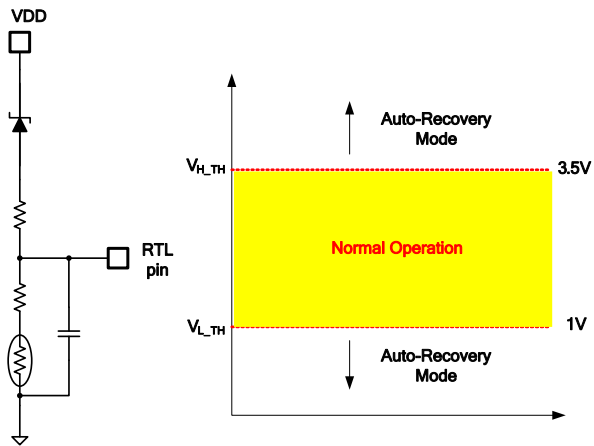
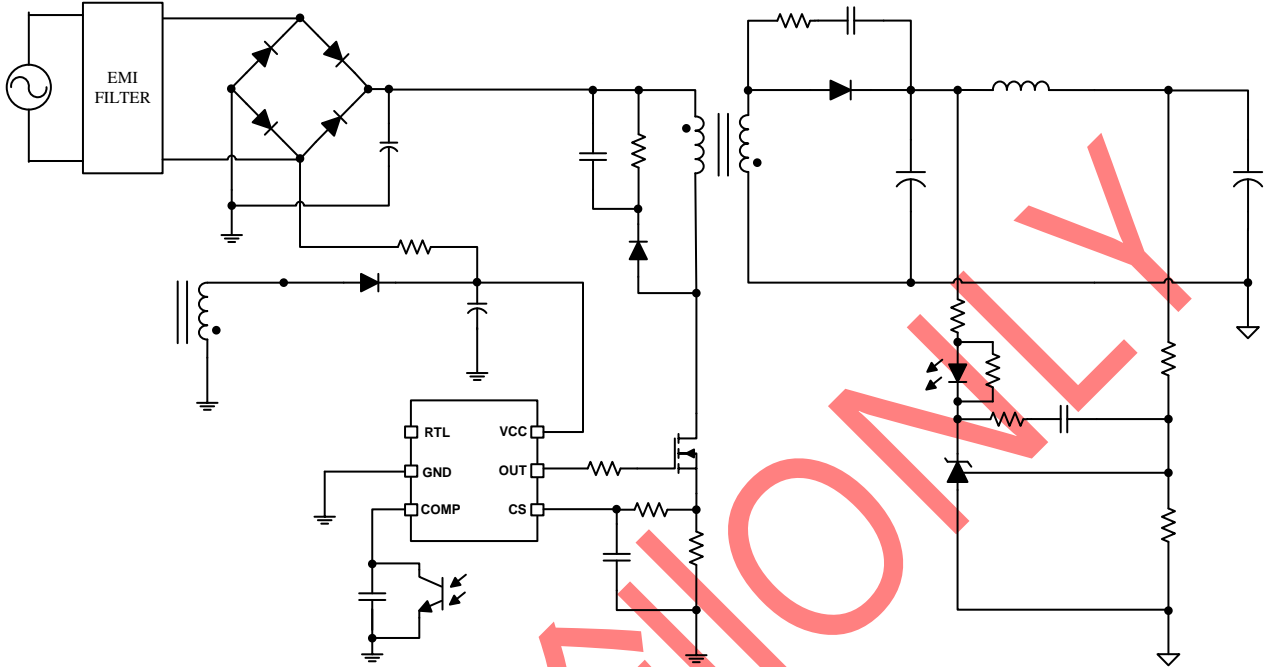

2. RTL Circuit

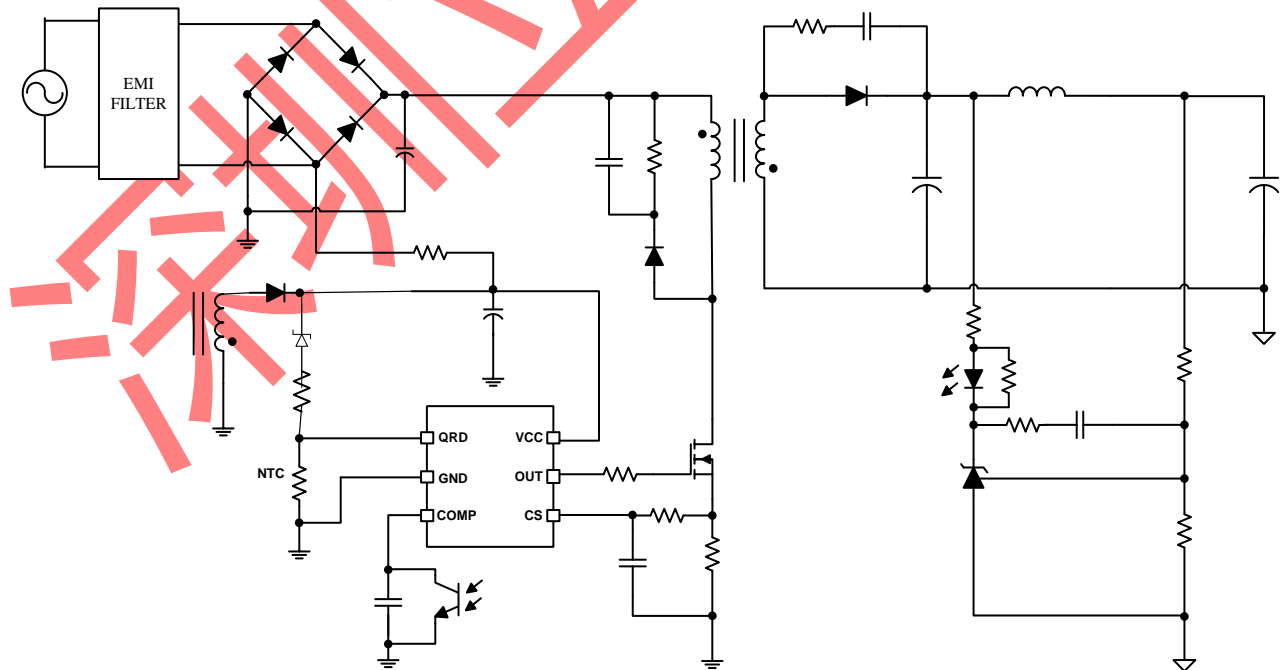

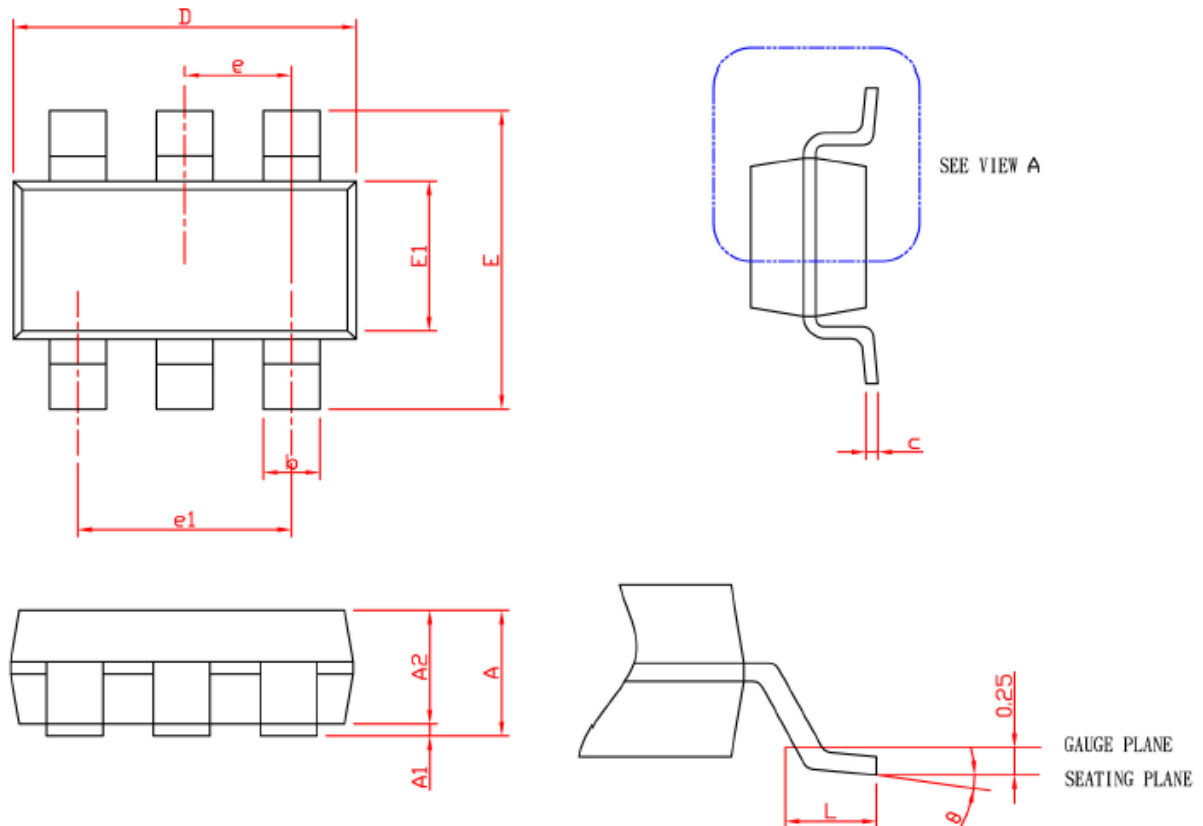
Package Information
SOT-26

SYMBOL	SOT-26			
	MILLIMETERS		INCHES	
	MIN.	MAX.	MIN.	MAX.
A		1.45		0.057
A1	0.00	0.15	0.000	0.006
A2	0.90	1.30	0.035	0.051
b	0.30	0.50	0.012	0.020
c	0.08	0.22	0.003	0.009
D	2.70	3.10	0.106	0.122
E	2.60	3.00	0.102	0.118
E1	1.40	1.80	0.055	0.071
e	0.95 BSC		0.037 BSC	
e1	1.90 BSC		0.075 BSC	
L	0.30	0.60	0.012	0.024
theta	0°	8°	0°	8°

Note: 1. Followed from JEDEC MO-178 AB.

2. Dimension D and E1 do not include mold flash, protrusions or gate burrs. Mold flash, protrusions or gate burrs shall not exceed 10 mil per side

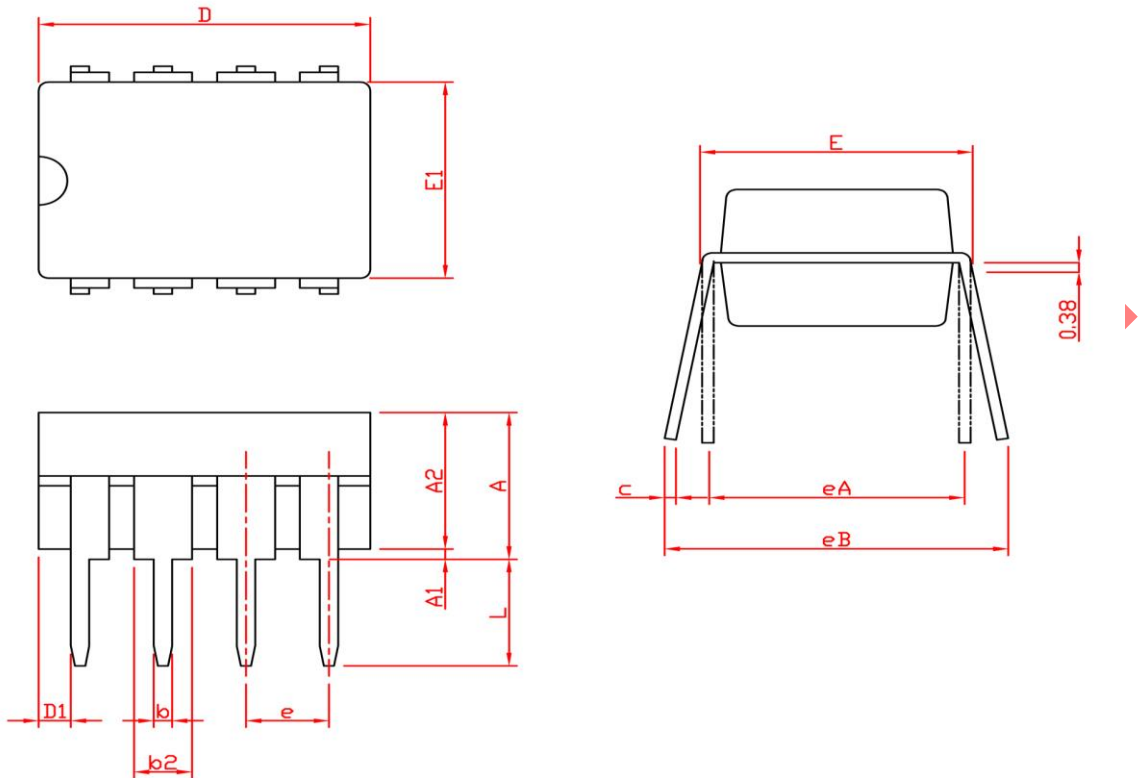
Package Information
DIP-8

SYMBOL	DIP-8			
	MILLIMETERS		INCHES	
	MIN.	MAX.	MIN.	MAX.
A		5.33		0.210
A1	0.38		0.015	
A2	2.92	4.95	0.115	0.195
b	0.36	0.56	0.014	0.022
b2	1.14	1.78	0.045	0.070
c	0.20	0.35	0.008	0.014
D	9.01	10.16	0.355	0.400
D1	0.13		0.005	
E	7.62	8.26	0.300	0.325
E1	6.10	7.11	0.240	0.280
e	2.54 BSC		0.100 BSC	
eA	7.62 BSC		0.300 BSC	
eB		10.92		0.430
L	2.92	3.81	0.115	0.150

Note: 1. Followed from JEDEC MS-001 BA.

2. Dimension D, D1 and E1 do not include mold flash or protrusions. Mold flash or protrusions shall not exceed 10 mil.

Carrier Tape & Reel Dimensions SOT-26

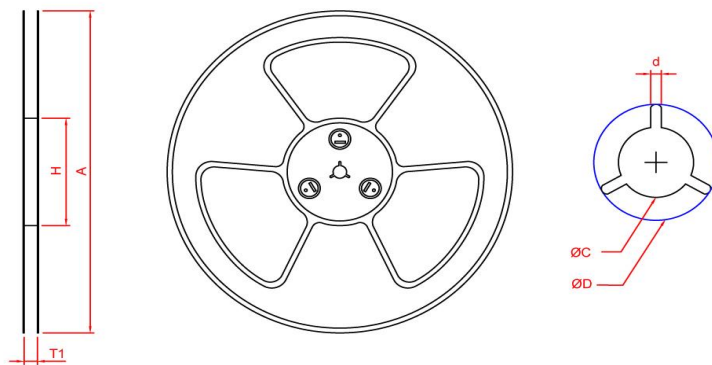
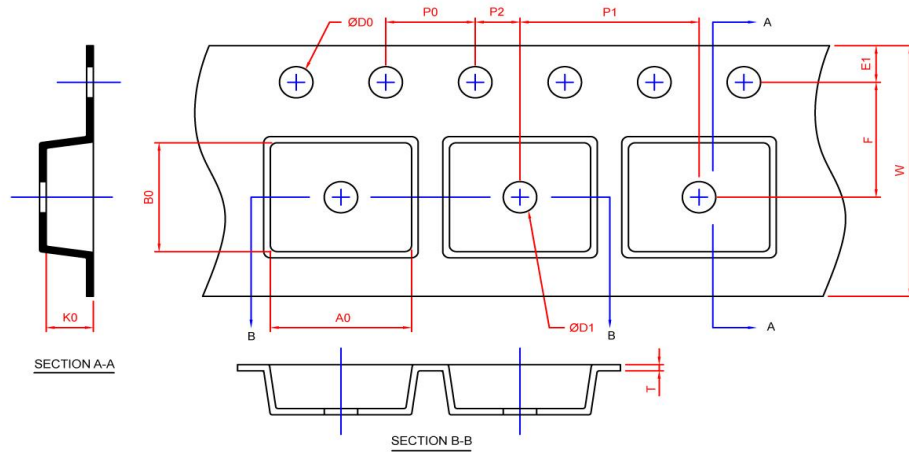

Application	A	H	T1	C	d	D	W	E1	F
SOT-26	178.0±2.00	50 MIN.	8.4+2.00 -0.00	13.0+0.50 -0.20	1.5 MIN.	20.2 MIN.	8.0±0.30	1.75±0.10	3.5±0.05
	P0	P1	P2	D0	D1	T	A0	B0	K0
	4.0±0.10	4.0±0.10	2.0±0.05	1.5+0.10 -0.00	1.0 MIN.	0.6+0.00 -0.40	3.20±0.20	3.10±0.20	1.50±0.20

Application	Carrier Width	Cover Tape Width	Devices Per Reel
SOT -26	8	5.3	3000

(mm)

Tape and Specification Reel

SOT 26

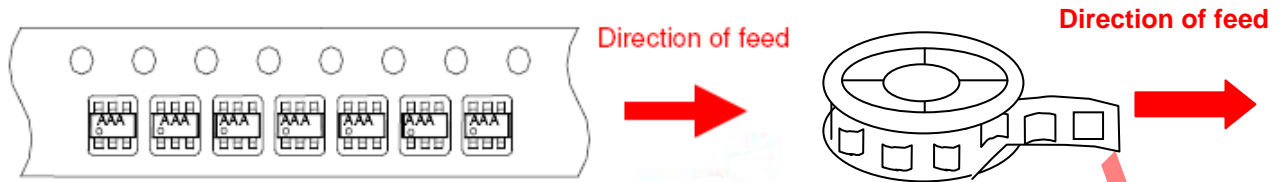

仅供内部使用

Nanjing Greenchip Semiconductor Co., Ltd. (Greenergy OPTO Inc.) reserves the right to make corrections, modifications, enhancements, improvements, and other changes to its products and services at any time and to discontinue any product or service without notice. Customers should obtain the latest relevant information before placing orders and should verify that such information is current and complete.