

Specifications

- Current rating:1A AC,DC
- Voltage rating:125V AC,DC
- Temperature range:-40°C~+105°C
- Contact resistance:20mΩMax.
- Insulation resistance:1000MΩMin.
- Withstanding voltage:250V AC/minute
- *Compliant with RoHS and REACH*
- *Meet the HF/Halogen Free,need to customize*
- *Contact CJT for details*

Standards



Assembly layout

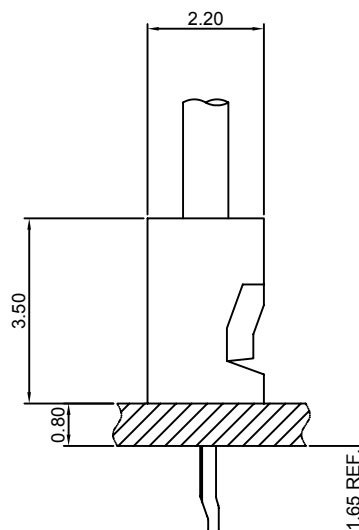



B1251 SERIES

1.25mm pitch board-in connector

B1251-T

1.25mm pitch Crimp Terminal

Reference Informations:

*Used in CJT B1251H-XP series Housing

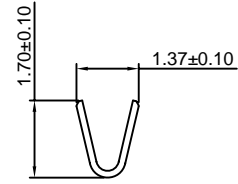
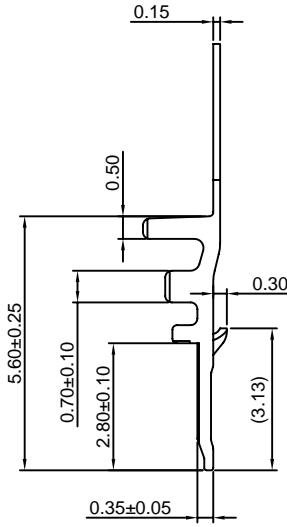
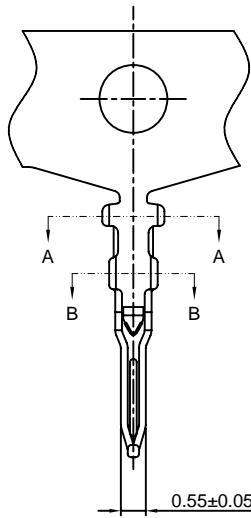

SEC:A-A

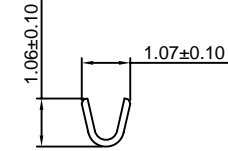

SEC:B-B

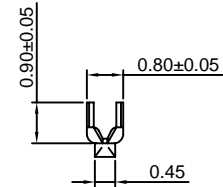

Unit:mm

Ordering information & Specifications:

Part NO.	Wire Range	Insulation O.D.	Material	Finish	Qty/reel
B1251-TP	AWG#28-#32	1.00mm(max)	Phosphor Bronze	Tin over Nickel	15,000 PCS
B1251-GP	AWG#28-#32	1.00mm(max)	Phosphor Bronze	Gold over Nickel	15,000 PCS

Optional Gold plating available but MOQ requested

B1251H-XP

1.25mm pitch Housing

Reference Informations:

- *Material:Nylon 66,UL94V-0
- *Suitable CJT B1251-T series Terminal
- *Color:White

Ordering Information:

- B1251H-XP - ***
 1 2
 1.Part No.
 2.Material:
 (blank):Nylon 66,UL94V-0
 GWT:Nylon 66,UL94V-0,GWT 750°C

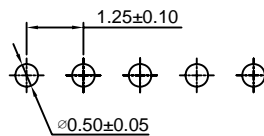
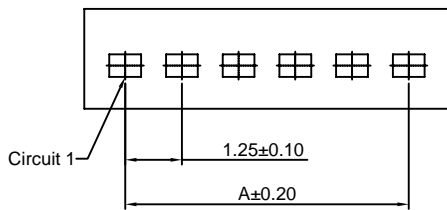

P.C.B LAYOUT

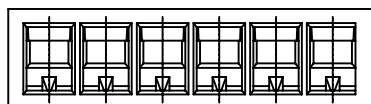
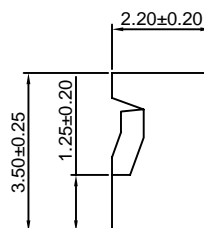
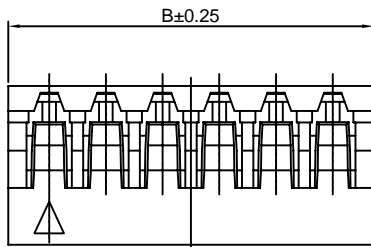
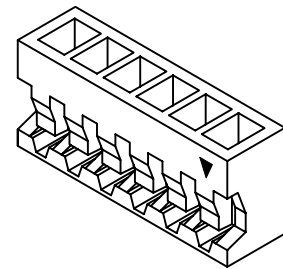

Ordering Information & Dimensions:

PART NO.	Dimensions	
	A	B
2P	1.25	3.05
3P	2.50	4.30
4P	3.75	5.55
5P	5.00	6.80
6P	6.25	8.05
7P	7.50	9.30
8P	8.75	10.55
9P	10.00	11.80
10P	11.25	13.05
11P	12.50	14.30
12P	13.75	15.55
13P	15.00	16.80
14P	16.25	18.05
15P	17.50	19.30

Unit: mm