

200V Half-Bridge Driver
PRODUCT SUMMARY

- V_{OFFSET} 200 V max.
- $I_{\text{O}+/-}$ 130 mA/270 mA
- V_{OUT} 10 V - 20 V
- $t_{\text{on/off}}$ (typ.) 680 ns/150 ns
- **Deadtime** (typ.) 520 ns

GENERAL DESCRIPTION

The SLM2003S is a high voltage, high speed power MOSFET and IGBT drivers with dependent high- and low-side referenced output channels. Proprietary HVIC and latch immune CMOS technologies enable ruggedized monolithic construction. The logic input is compatible with standard CMOS or LSTTL output, down to 3.3 V logic. The output drivers feature a high pulse current buffer stage designed for minimum driver cross conduction. The floating channel can be used to drive an N-channel power MOSFET or IGBT in the high-side configuration which operates up to 200 V.

FEATURES

- Floating channel designed for bootstrap operation
- Fully operational to +200 V
- Tolerant to negative transient voltage, dV/dt immune
- Gate drive supply range from 10 V to 20 V
- Undervoltage lockout
- 3.3 V, 5 V, and 15 V logic compatible
- Cross-conduction prevention logic
- Matched propagation delay for both channels
- Internal set deadtime
- High-side output in phase with HIN input
- Low-side output out of phase with LIN input
- RoHS compliant
- SOIC-8 and PDIP-8 package

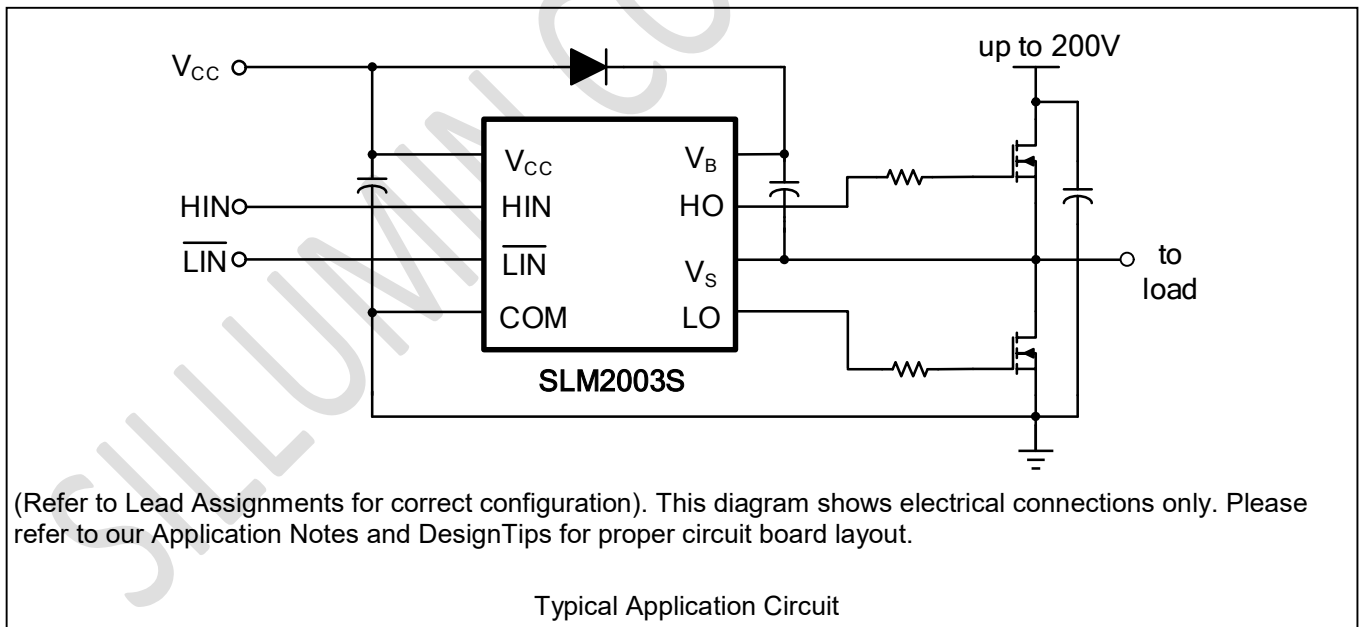
TYPICAL APPLICATION CIRCUIT

PIN CONFIGURATION

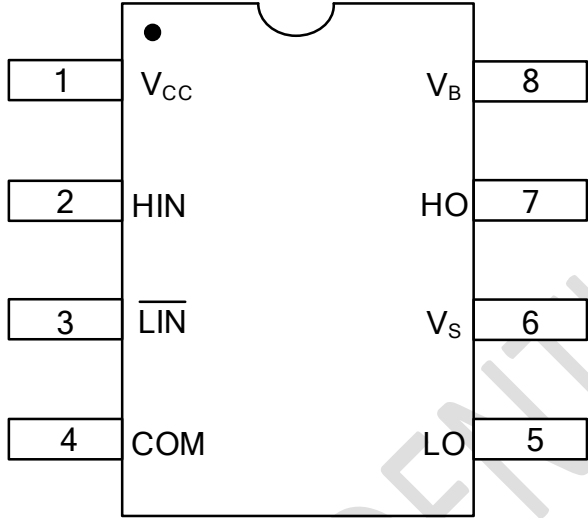
Package	Pin Configuration (Top View)
SOIC-8 and PDIP-8	 <p>The diagram shows a top view of an 8-pin package. Pin 1 is V_{CC}, Pin 2 is H_{IN}, Pin 3 is $\overline{\text{LIN}}$, Pin 4 is COM, Pin 5 is LO, Pin 6 is V_S, Pin 7 is HO, and Pin 8 is V_B. A notch is present at the top of the package, and a dot is at the top-left corner.</p>

PIN DESCRIPTION

No.	Pin	Description
1	V _{CC}	Low-side and logic fixed supply
2	H _{IN}	Logic input for high-side gate driver output (HO), in phase
3	$\overline{\text{LIN}}$	Logic input for low-side gate driver output (LO), out of phase
4	COM	Low-side return
5	LO	Low-side gate drive output
6	V _S	High-side floating supply return
7	HO	High-side gate drive output
8	V _B	High-side floating supply

ORDERING INFORMATION
Industrial Range: -40°C to +125°C

Order Part No.	Package	QTY
SLM2003SCA-13GTR	SOIC8, Pb-Free	2500/Reel
SLM2003SCA-GT	SOIC8, Pb-Free	100/Tube
SLM2003SDA-GT	PDIP8, Pb-Free	100/Tube

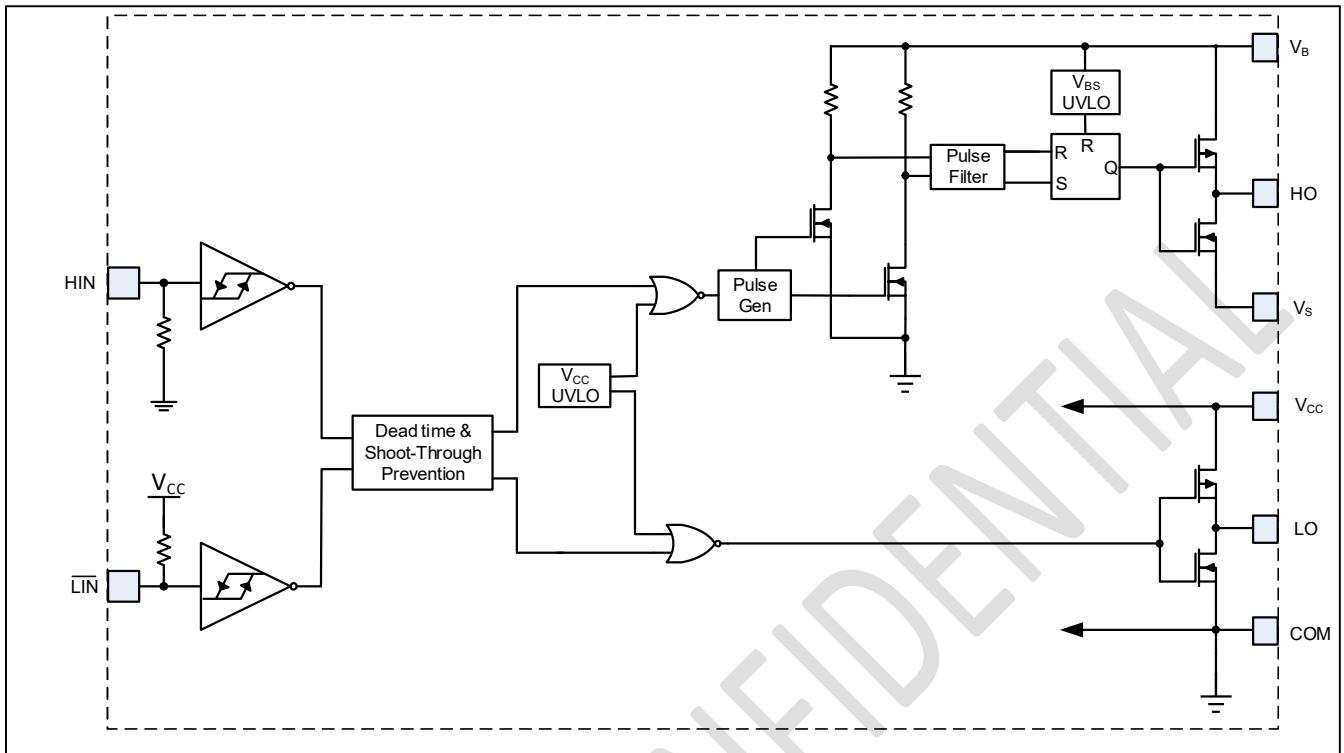
FUNCTIONAL BLOCK DIAGRAM

ABSOLUTE MAXIMUM RATINGS

Symbol	Definition	Min.	Max.	Units	
V_B	High-side floating absolute voltage	-0.3	225	V	
V_S	High-side floating supply offset voltage	$V_B - 25$	$V_B + 0.3$		
V_{HO}	High-side floating output voltage	$V_S - 0.3$	$V_B + 0.3$		
V_{CC}	Low-side and logic fixed supply voltage	-0.3	25		
V_{LO}	Low-side output voltage	-0.3	$V_{CC} + 0.3$		
V_{IN}	Logic input voltage (HIN & LIN)	-0.3	$V_{CC} + 0.3$		
dV_S/dt	Allowable offset supply voltage transient	---	50	V/ns	
P_D	Package power dissipation @ $T_A \leq +25^\circ\text{C}$	PDIP-8	---	1.0	W
		SOIC-8	---	0.625	
R_{thJA}	Thermal resistance, junction to ambient	PDIP-8	---	125	$^\circ\text{C/W}$
		SOIC-8	---	200	
T_J	Junction temperature	---	150	$^\circ\text{C}$	
T_S	Storage temperature	-55	150		
T_L	Lead temperature (soldering, 10 seconds)	---	300		

Note:

Absolute maximum ratings indicate sustained limits beyond which damage to the device may occur. All voltage parameters are absolute voltages referenced to COM. The thermal resistance and power dissipation ratings are measured under board mounted and still air conditions.

RECOMMENDED OPERATING CONDITIONS

Symbol	Definition	Min.	Max.	Units
V_B	High-side floating absolute voltage	$V_S + 10$	$V_S + 20$	V
V_S	High-side floating supply offset voltage	Note 1	200	
V_{HO}	High-side floating output voltage	V_S	V_B	
V_{CC}	Low-side and logic fixed supply voltage	10	20	
V_{LO}	Low-side output voltage	0	V_{CC}	
V_{IN}	Logic input voltage (HIN & LIN)	0	V_{CC}	
T_A	Ambient temperature	- 40	125	$^\circ\text{C}$

Note:

The input/output logic timing diagram is shown in Fig. 1. For proper operation the device should be used within the recommended conditions. The V_S offset rating is tested with all supplies biased at a 15 V differential.

DYNAMIC ELECTRICAL CHARACTERISTICS
 $V_{BIAS} (V_{CC}, V_{BS}) = 15\text{ V}$, $C_L = 1000\text{ pF}$ and $T_A = 25^\circ\text{C}$ unless otherwise specified.

Symbol	Parameter	Condition	Min.	Typ.	Max.	Unit
t_{on}	Turn-on propagation delay	$V_s = 0\text{ V}$	---	680	820	ns
t_{off}	Turn-off propagation delay	$V_s = 200\text{ V}$	---	150	220	
t_r	Turn-on rise time		---	70	170	
t_f	Turn-off fall time		---	35	90	
DT	Deadtime, LS turn-off to HS turn-on & HS turn-on to LS turn-off		400	520	650	
MT	Delay matching, HS & LS turn-on/off		---	---	60	

STATIC ELECTRICAL CHARACTERISTICS
 $V_{BIAS} (V_{CC}, V_{BS}) = 15\text{ V}$ and $T_A = 25^\circ\text{C}$ unless otherwise specified. The V_{IN} , V_{TH} , and I_{IN} parameters are referenced to COM. The V_O and I_O parameters are referenced to COM and are applicable to the respective output leads: HO or LO.

Symbol	Parameter	Condition	Min.	Typ.	Max.	Unit
V_{IH}	Logic "1" (HIN) & Logic "0" (LIN) input voltage	$V_{CC} = 10\text{ V to }20\text{ V}$	2.5	---	---	V
V_{IL}	Logic "0" (HIN) & Logic "1" (LIN) input voltage		---	---	0.8	
V_{OH}	High level output voltage, $V_{BIAS} - V_O$	$I_O = 2\text{ mA}$	---	0.05	0.2	
V_{OL}	Low level output voltage, V_O		---	0.02	0.1	
I_{LK}	Offset supply leakage current	$V_B = V_s = 200\text{ V}$	---	---	50	μA
I_{QBS}	Quiescent V_{BS} supply current	$V_{IN} = 0\text{ V or }5\text{ V}$	---	60	75	
I_{QCC}	Quiescent V_{CC} supply current		---	170	270	
I_{IN+}	Logic "1" input bias current	$HIN = 5\text{ V}, \overline{LIN} = 0\text{ V}$	---	3	10	
I_{IN-}	Logic "0" input bias current	$HIN = 0\text{ V}, \overline{LIN} = 5\text{ V}$	---	---	5	
V_{CCUV+} V_{BSUV+}	V_{CC} supply undervoltage positive going threshold		8	8.9	9.8	V
V_{CCUV-} V_{BSUV-}	V_{CC} supply undervoltage negative going threshold		7.4	8.2	9	
I_{O+}	Output high short circuit pulsed current	$V_O = 0\text{ V}, V_{IN} = V_{IH}$ $PW \leq 10\text{ }\mu\text{s}$	130	290		mA
I_{O-}	Output low short circuit pulsed current	$V_O = 15\text{ V}, V_{IN} = V_{IL}$ $PW \leq 10\text{ }\mu\text{s}$	270	600		

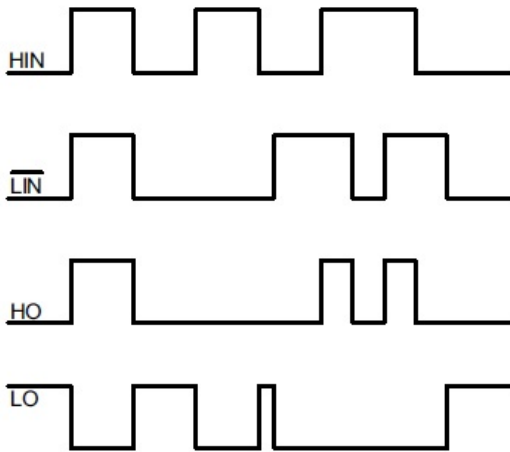

Figure 1. Input/Output Timing Diagram

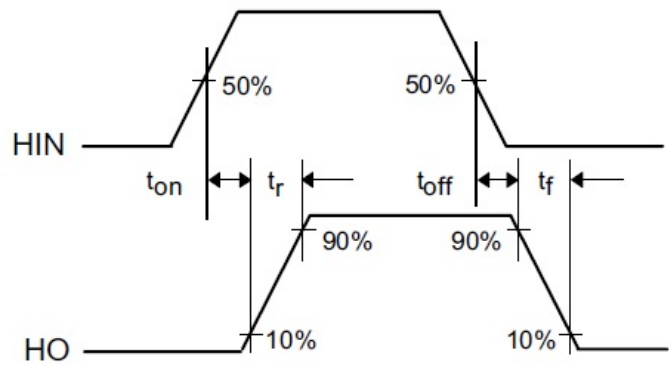
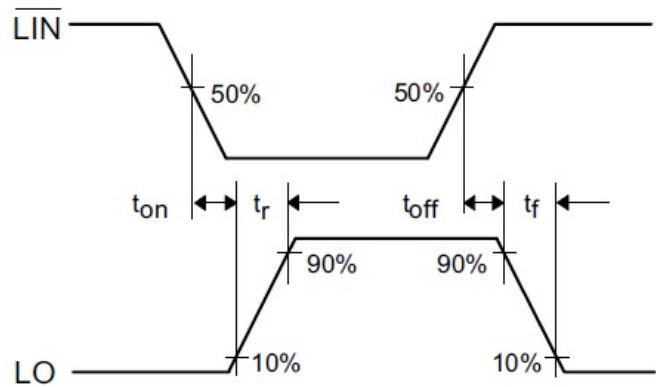

Figure 2. Switching Time Waveform Definitions

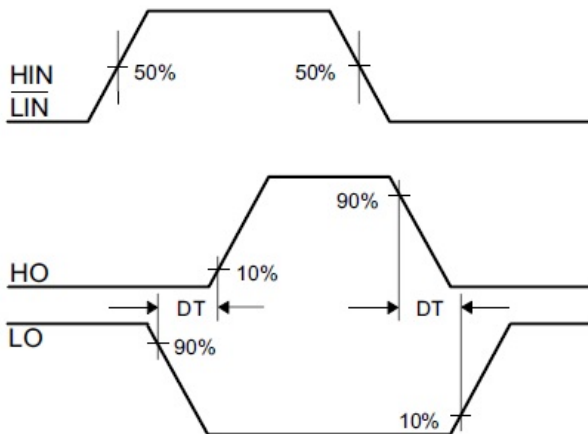
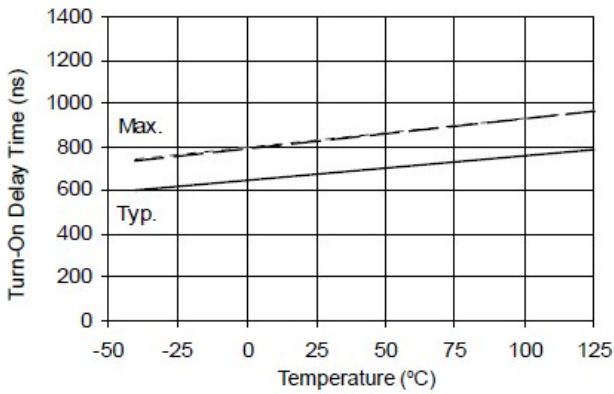
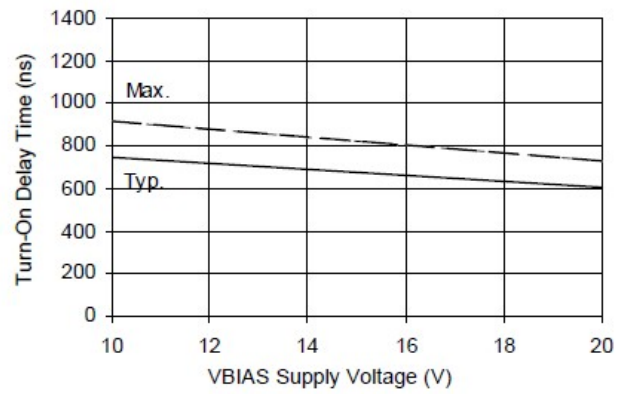
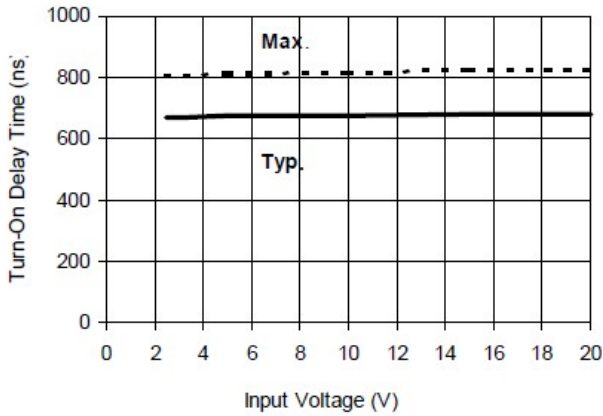
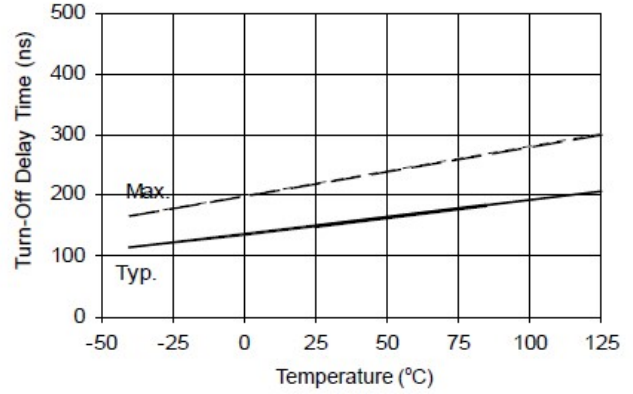
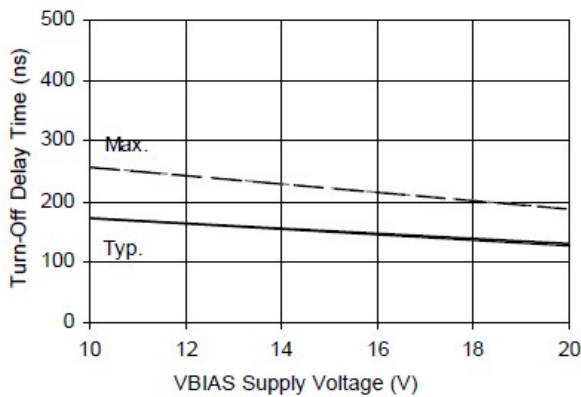
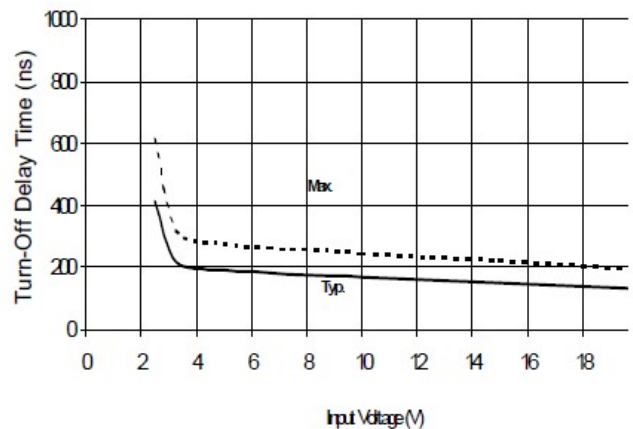

Figure 3. Deadtime Waveform Definitions

Figure 4A. Turn-On Time vs. Temperature

Figure 4B. Turn-On Time vs. Supply Voltage

Figure 4C. Turn-On Time vs. Input Voltage

Figure 5A. Turn-Off Time vs. Temperature

Figure 5B. Turn-Off Time vs. Supply Voltage

Figure 5C. Turn-Off Time vs. Input Voltage

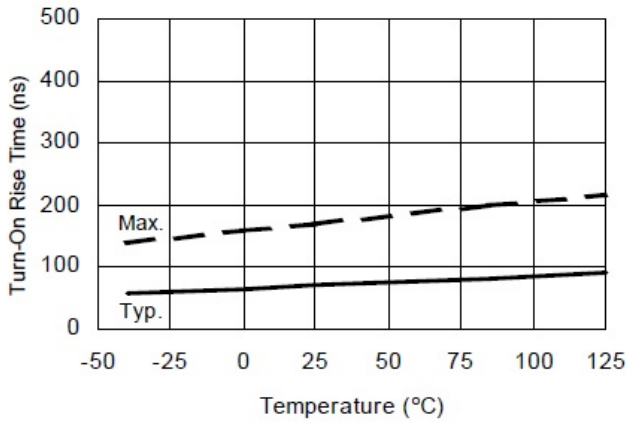

Figure 6A. Turn-On Rise Time vs. Temperature

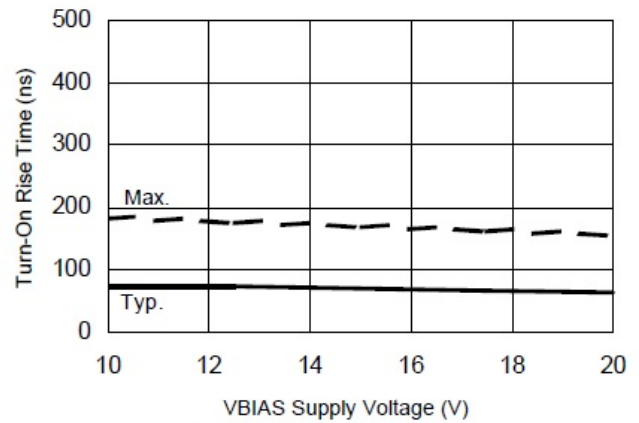

Figure 6B. Turn-On Rise Time vs. Voltage

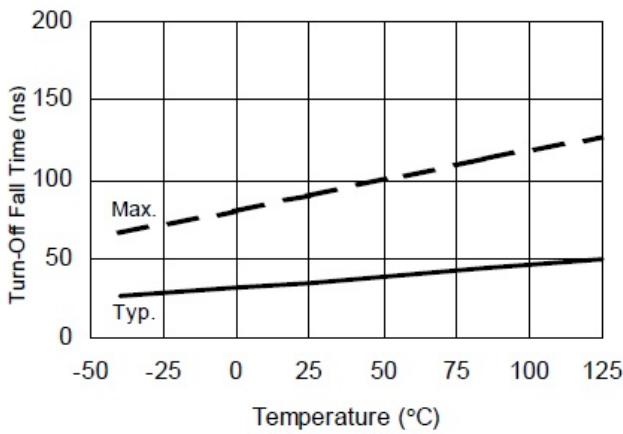

Figure 7A. Turn-Off Fall Time vs. Temperature

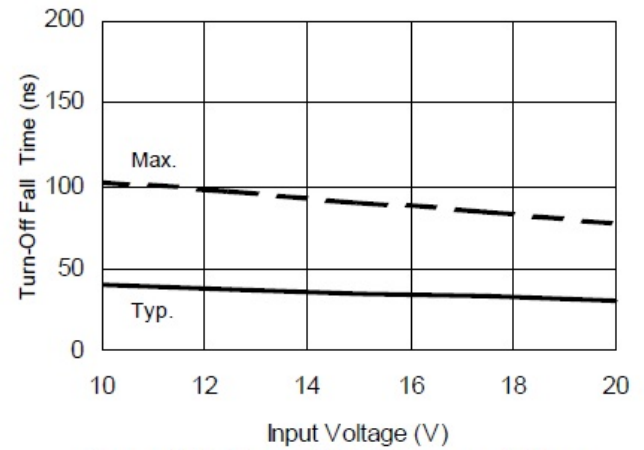

Figure 7B. Turn-Off Fall Time vs. Voltage

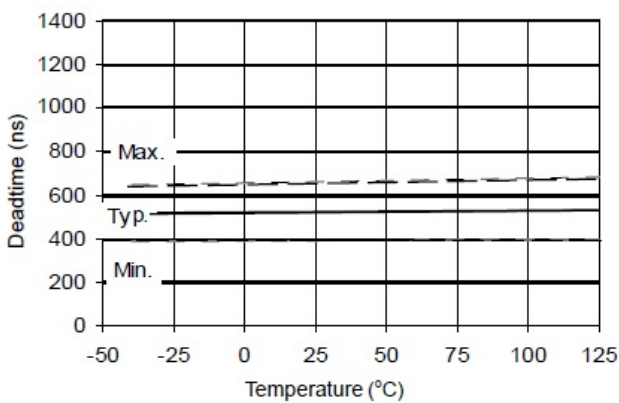

Figure 8A. Deadtime vs. Temperature

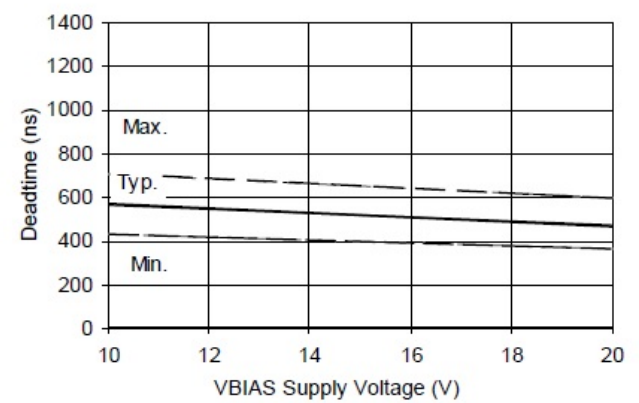

Figure 8B. Deadtime vs. Voltage

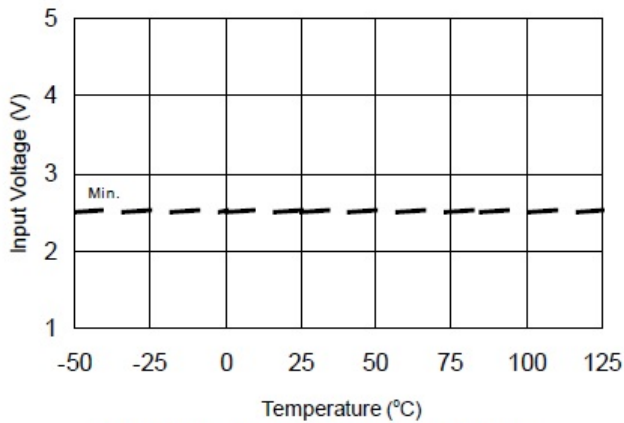

Figure 9A. Logic "1" Input Voltage vs. Temperature

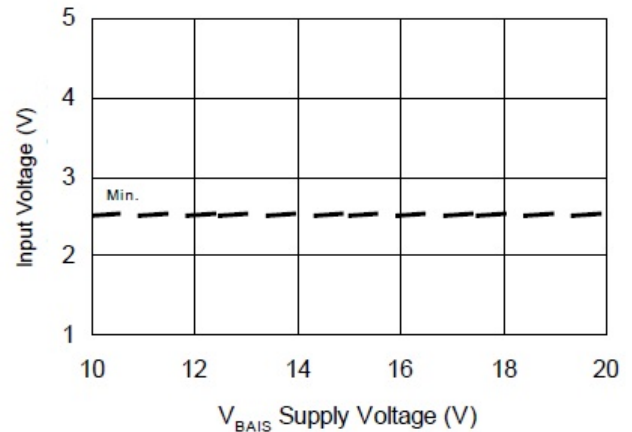

Figure 9B. Logic "1" Input Voltage vs. Supply Voltage

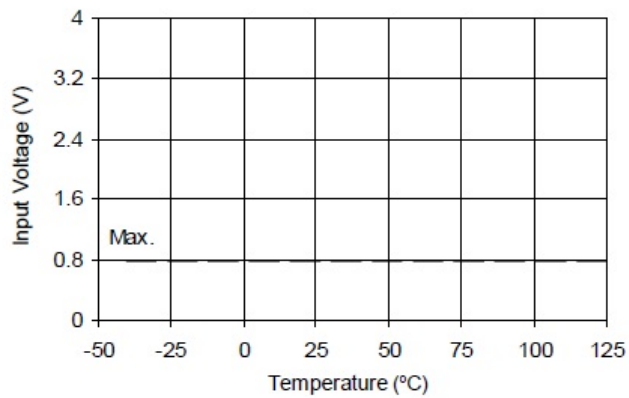

Figure 10A. Logic "0" (HIN) & Logic "1" (LIN) Input Voltage vs. Temperature

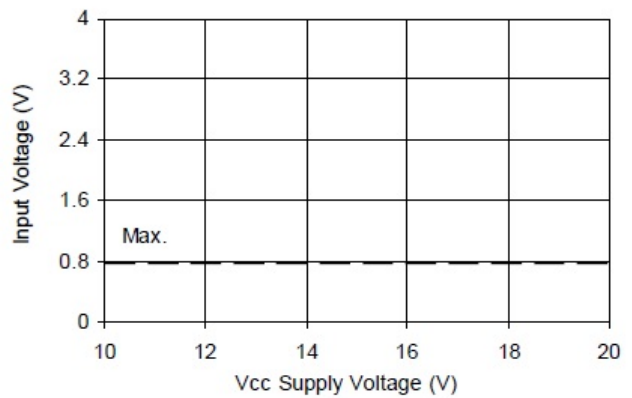

Figure 10B. Logic "0" (HIN) & Logic "1" (LIN) Input Voltage vs. Voltage

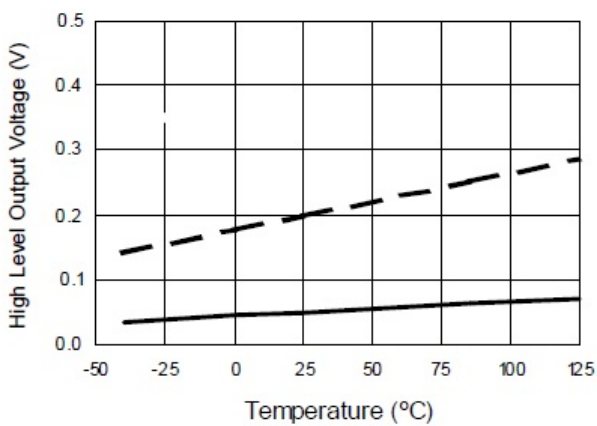

Figure 11A. High Level Output Voltage vs. Temperature

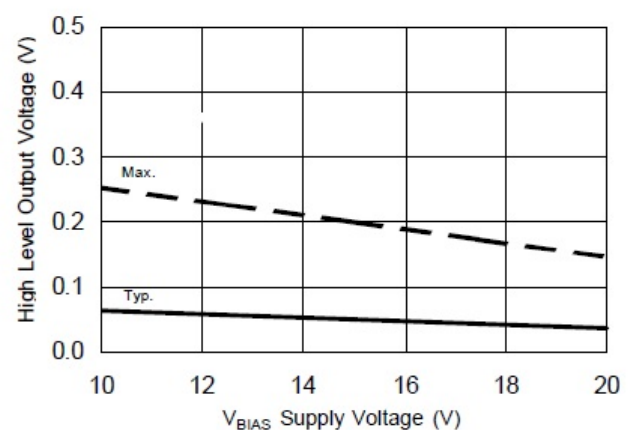

Figure 11B. High Level Output Voltage vs. Supply Voltage

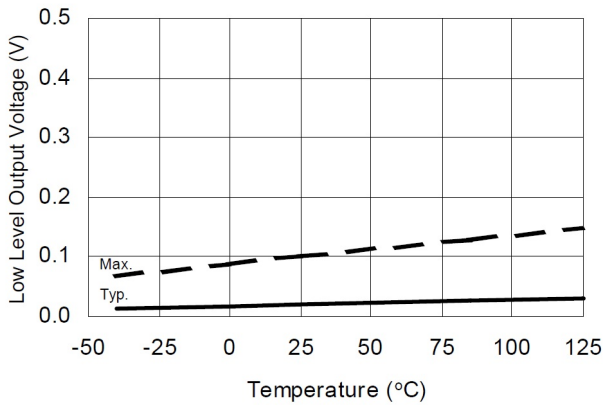

Figure 12A. Low Level Output Voltage vs. Temperature

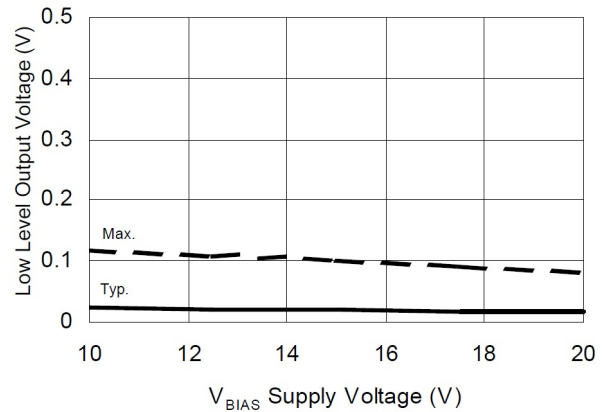

Figure 12B. Low Level Output Voltage vs. Supply Voltage

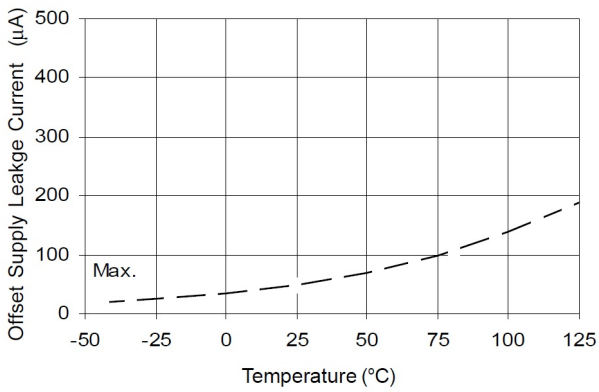

Figure 13A. Offset Supply Current vs. Temperature

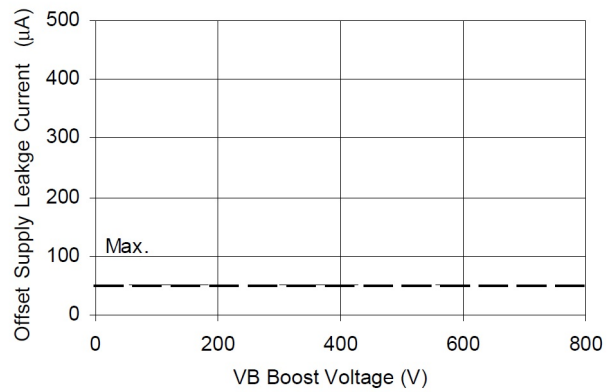

Figure 13B. Offset Supply Current vs. Voltage

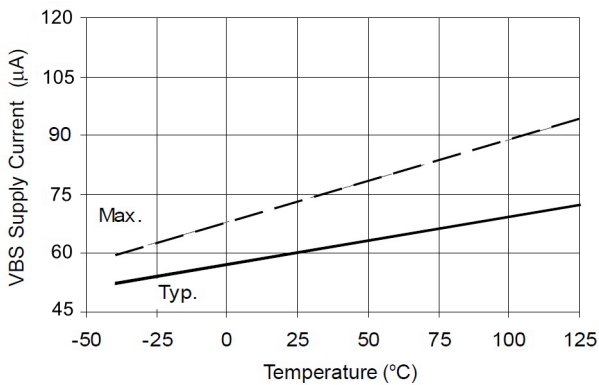

Figure 14A. V_{BS} Supply Current vs. Temperature

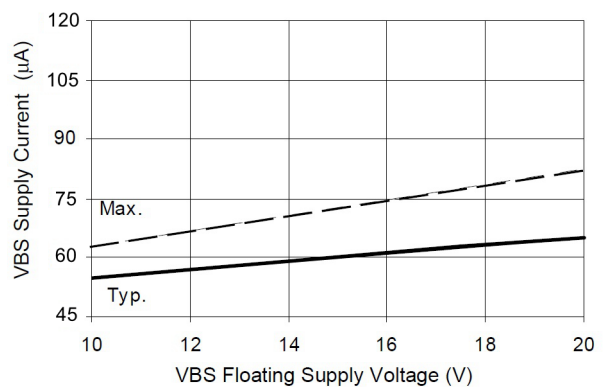

Figure 14B. V_{BS} Supply Current vs. Voltage

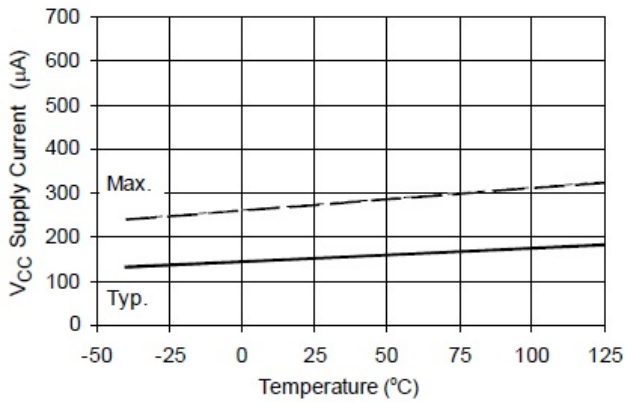

Figure 15A. V_{CC} Supply Current vs. Temperature

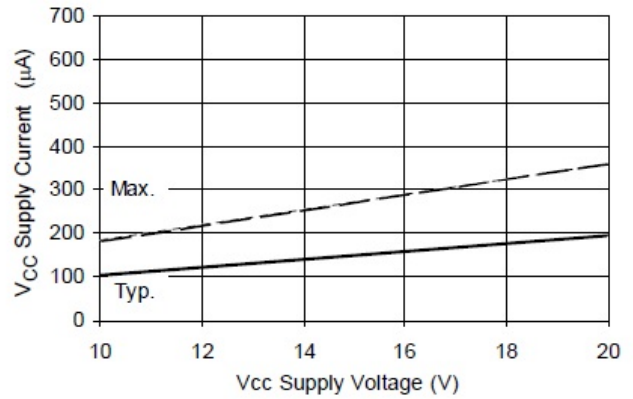

Figure 15B. V_{CC} Supply Current vs. Voltage

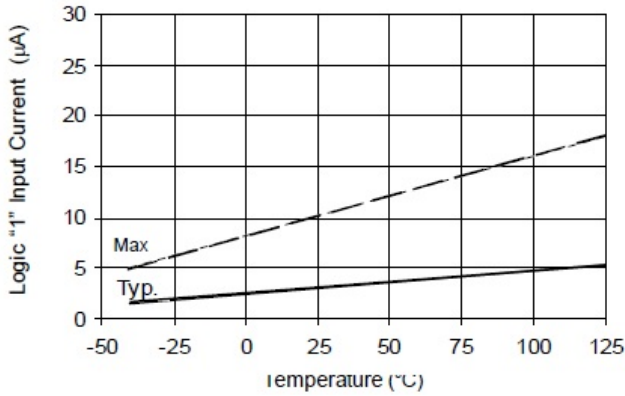

Figure 16A. Logic "1" Input Current vs. Temperature

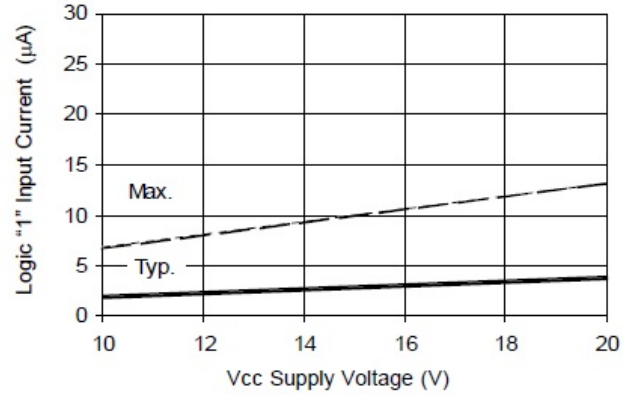

Figure 16B. Logic "1" Input Current vs. Voltage

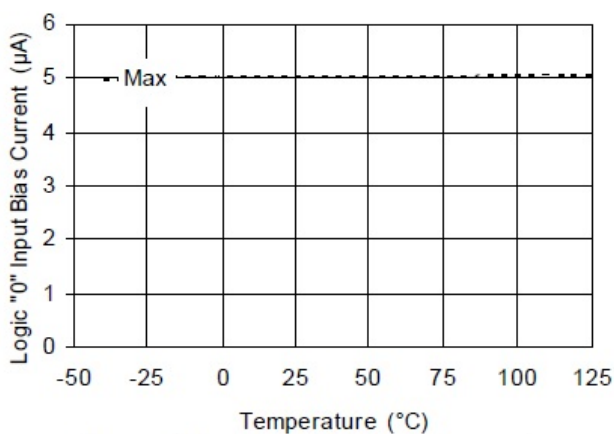

Figure 17A. Logic "0" Input Current vs. Temperature

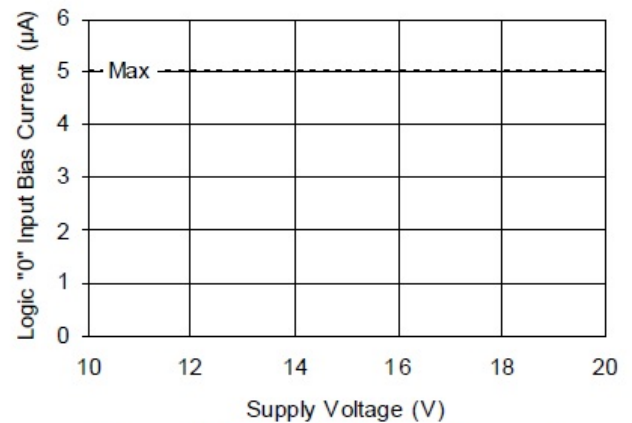

Figure 17B. Logic "0" Input Current vs. Voltage

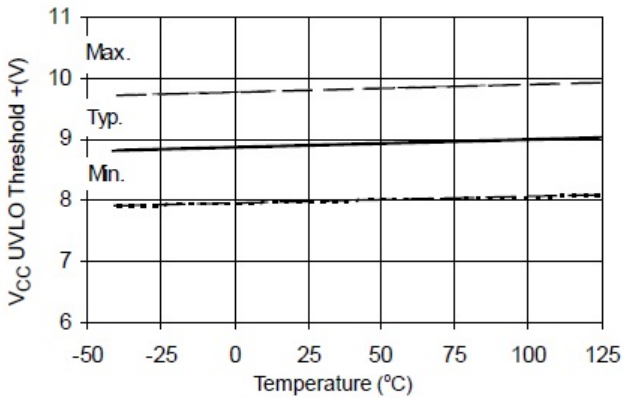

Figure 18A. V_{CC} Undervoltage Threshold(+) vs. Temperature

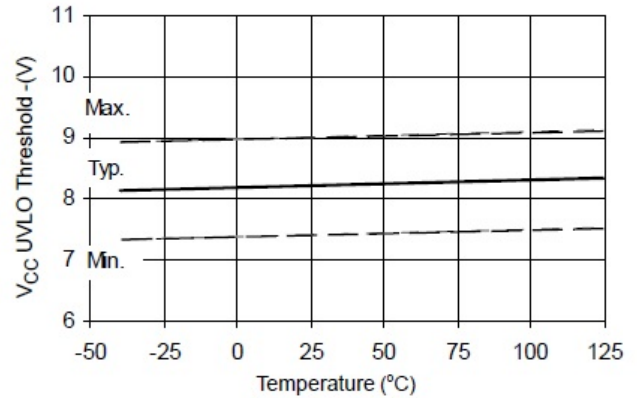

Figure 18B. V_{CC} Undervoltage Threshold (-) vs. Temperature

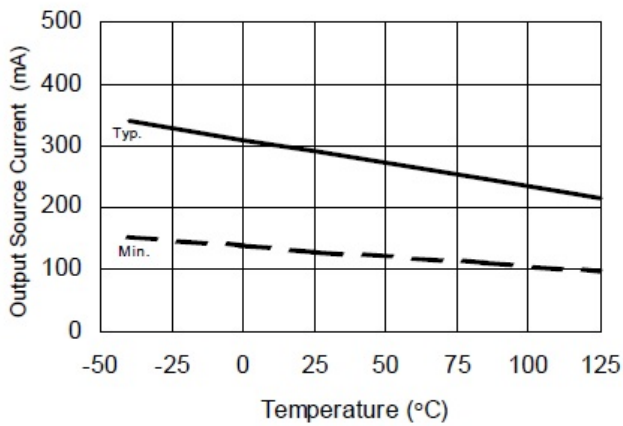

Figure 19A. Output Source Current vs. Temperature

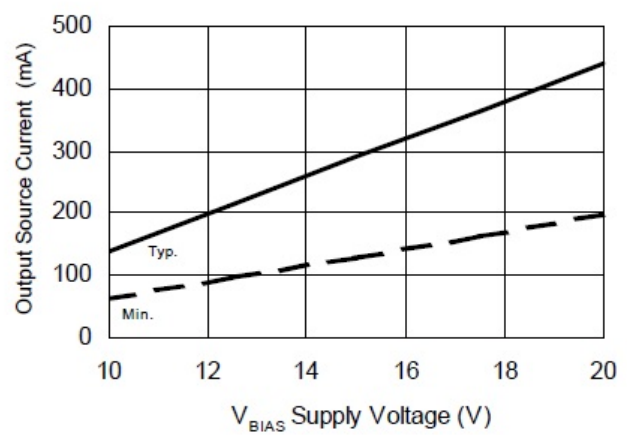

Figure 19B. Output Source Current vs. Supply Voltage

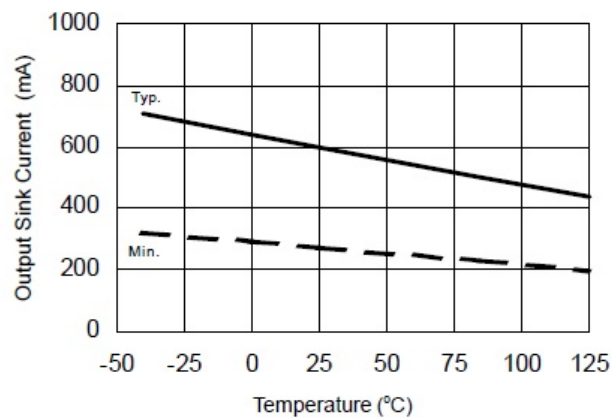

Figure 20A. Output Sink Current vs. Temperature

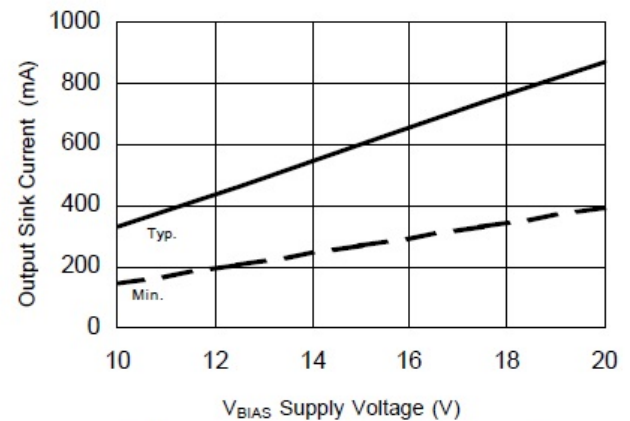
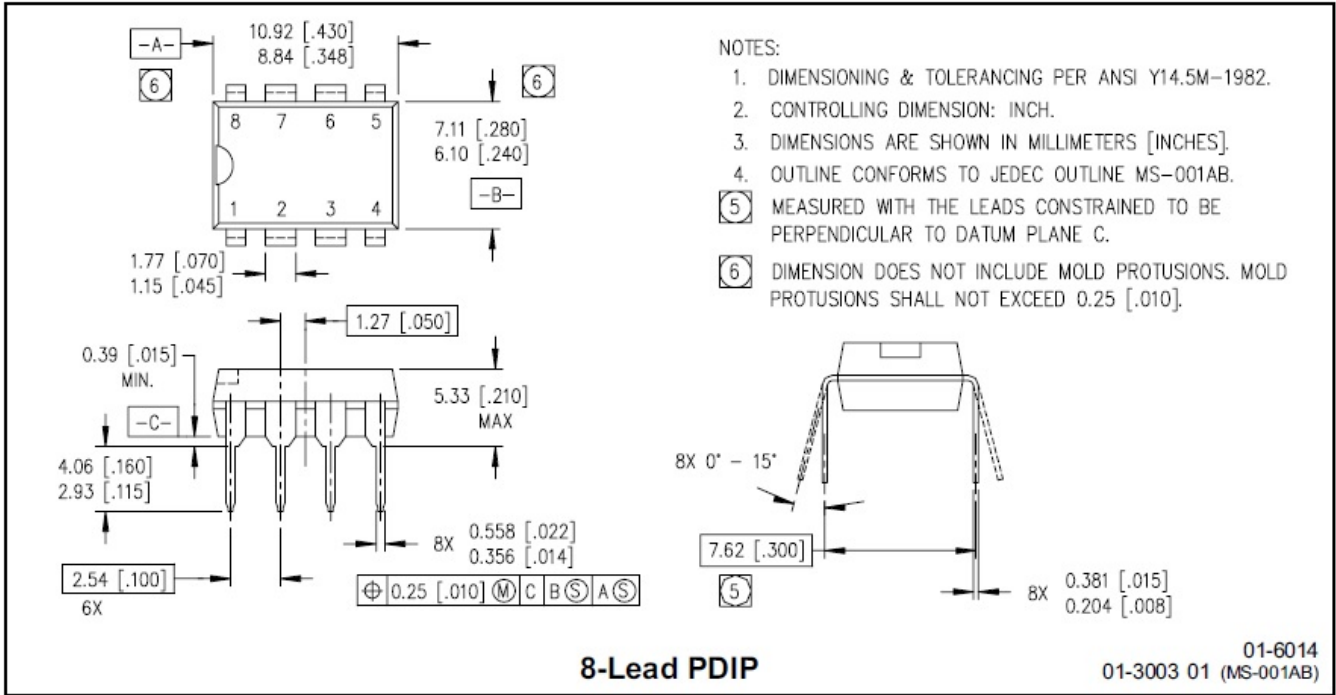
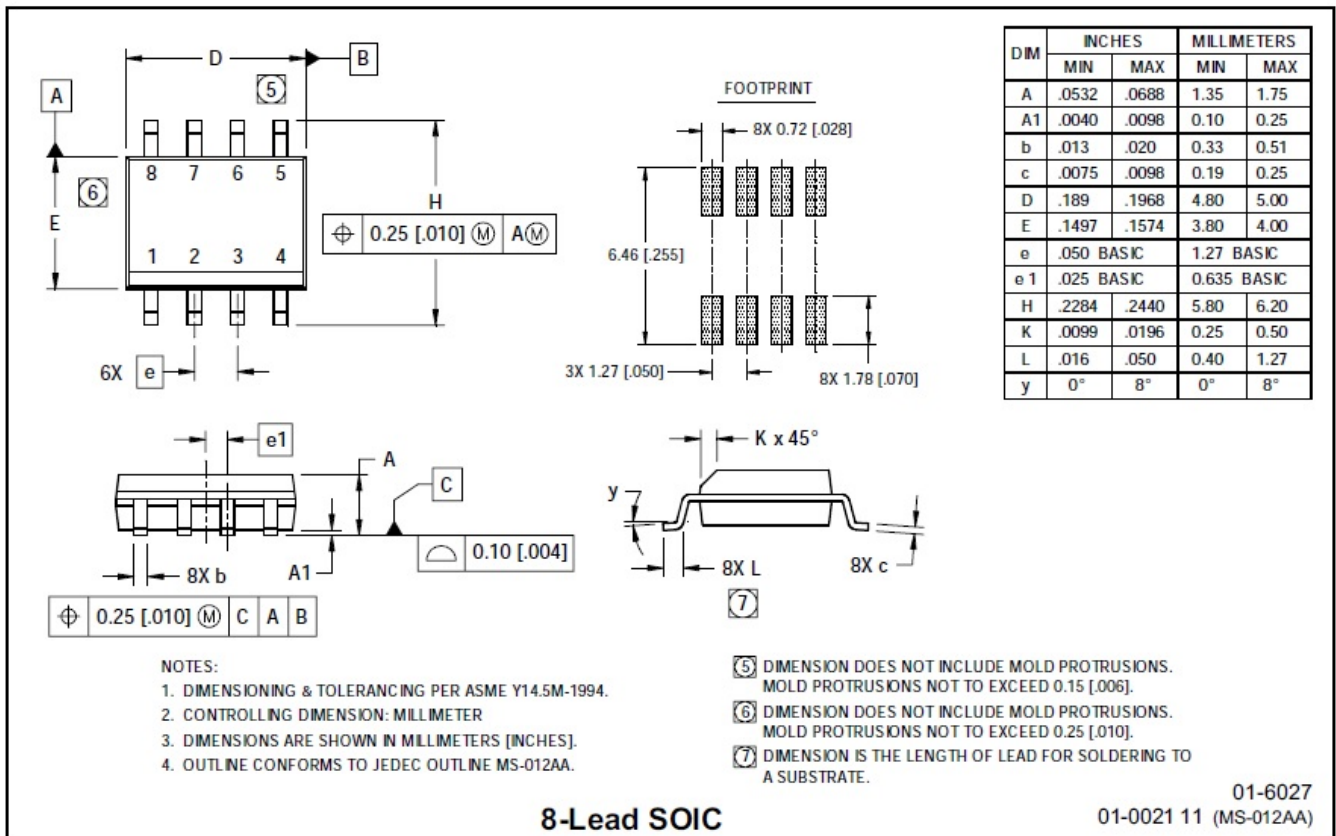

Figure 20B. Output Sink Current vs. Supply Voltage

PACKAGE CASE OUTLINES



8-Lead PDIP

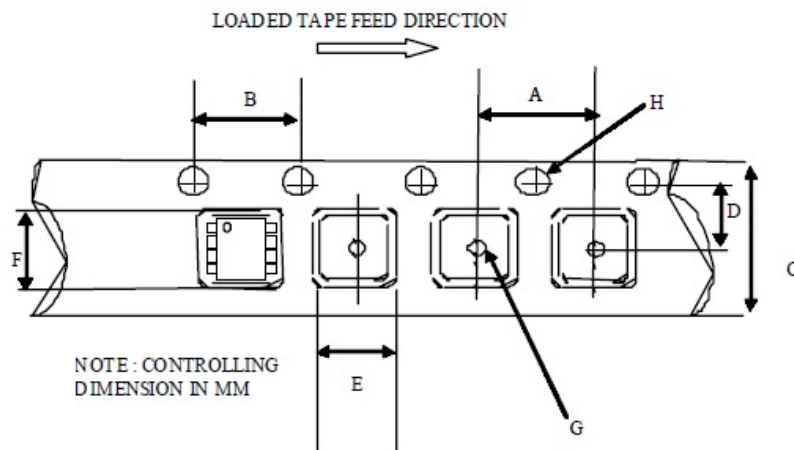

8-Lead SOIC

**Tape & Reel
8-lead SOIC**

CARRIER TAPE DIMENSION FOR 8SOICN

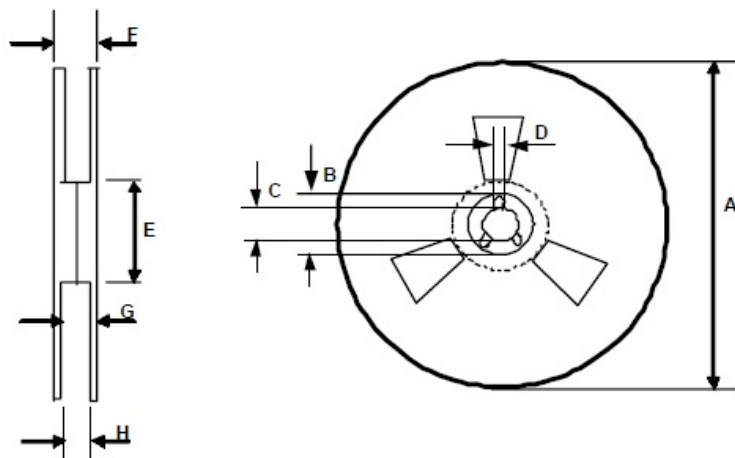
Code	Metric		Imperial	
	Min	Max	Min	Max
A	7.90	8.10	0.311	0.318
B	3.90	4.10	0.153	0.161
C	11.70	12.30	0.46	0.484
D	5.45	5.55	0.214	0.218
E	6.30	6.50	0.248	0.255
F	5.10	5.30	0.200	0.208
G	1.50	n/a	0.059	n/a
H	1.50	1.60	0.059	0.062

REEL DIMENSIONS FOR 8SOICN

Code	Metric		Imperial	
	Min	Max	Min	Max
A	329.60	330.25	12.976	13.001
B	20.95	21.45	0.824	0.844
C	12.80	13.20	0.503	0.519
D	1.95	2.45	0.767	0.096
E	98.00	102.00	3.858	4.015
F	n/a	18.40	n/a	0.724
G	14.50	17.10	0.570	0.673
H	12.40	14.40	0.488	0.566

Revision History

Note: page numbers for previous revisions may differ from page numbers in current version

Page or Item	Subjects (major changes since previous revision)
Rev 1.0 datasheet, August,2019	
Whole document	New company logo released
Page 1	Remove "Fig1."