

IRFP250N

HEXFET® Power MOSFET

- Advanced Process Technology
- Dynamic dv/dt Rating
- 175°C Operating Temperature
- Fast Switching
- Fully Avalanche Rated
- Ease of Paralleling
- Simple Drive Requirements

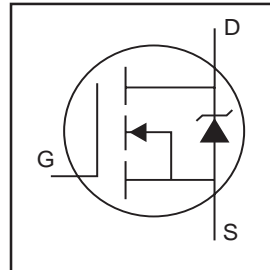

$V_{DS} = 200V$
$R_{DS(on)} = 0.075\Omega$
$I_D = 30A$

Description

Fifth Generation HEXFETs from International Rectifier utilize advanced processing techniques to achieve extremely low on-resistance per silicon area. This benefit, combined with the fast switching speed and ruggedized device design that HEXFET Power MOSFETs are well known for, provides the designer with an extremely efficient and reliable device for use in a wide variety of applications.

The TO-247 package is preferred for commercial-industrial applications where higher power levels preclude the use of TO-220 devices. The TO-247 is similar but superior to the earlier TO-218 package because of its isolated mounting hole.



Absolute Maximum Ratings

	Parameter	Max.	Units
$I_D @ T_C = 25^\circ C$	Continuous Drain Current, $V_{GS} @ 10V$	30	A
$I_D @ T_C = 100^\circ C$	Continuous Drain Current, $V_{GS} @ 10V$	21	
I_{DM}	Pulsed Drain Current ①	120	
$P_D @ T_C = 25^\circ C$	Power Dissipation	214	W
	Linear Derating Factor	1.4	W/°C
V_{GS}	Gate-to-Source Voltage	± 20	V
E_{AS}	Single Pulse Avalanche Energy②	315	mJ
I_{AR}	Avalanche Current①	30	A
E_{AR}	Repetitive Avalanche Energy①	21	mJ
dv/dt	Peak Diode Recovery dv/dt ③	8.6	V/ns
T_J	Operating Junction and	-55 to +175	°C
T_{STG}	Storage Temperature Range		
	Soldering Temperature, for 10 seconds		
	Mounting torque, 6-32 or M3 screw	10 lbf•in (1.1N•m)	

Thermal Resistance

	Parameter	Typ.	Max.	Units
$R_{\theta JC}$	Junction-to-Case	—	0.7	°C/W
$R_{\theta CS}$	Case-to-Sink, Flat, Greased Surface	0.24	—	
$R_{\theta JA}$	Junction-to-Ambient	—	40	

IRFP250N

International
IR Rectifier

Electrical Characteristics @ $T_J = 25^\circ\text{C}$ (unless otherwise specified)

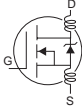
	Parameter	Min.	Typ.	Max.	Units	Conditions
$V_{(BR)DSS}$	Drain-to-Source Breakdown Voltage	200	—	—	V	$V_{GS} = 0V, I_D = 250\mu A$
$\Delta V_{(BR)DSS}/\Delta T_J$	Breakdown Voltage Temp. Coefficient	—	0.26	—	V/ $^\circ\text{C}$	Reference to $25^\circ\text{C}, I_D = 1\text{mA}$
$R_{DS(on)}$	Static Drain-to-Source On-Resistance	—	—	0.075	Ω	$V_{GS} = 10V, I_D = 18A$ ④
$V_{GS(th)}$	Gate Threshold Voltage	2.0	—	4.0	V	$V_{DS} = V_{GS}, I_D = 250\mu A$
g_{fs}	Forward Transconductance	17	—	—	S	$V_{DS} = 50V, I_D = 18A$ ④
I_{DSS}	Drain-to-Source Leakage Current	—	—	25	μA	$V_{DS} = 200V, V_{GS} = 0V$
		—	—	250		$V_{DS} = 160V, V_{GS} = 0V, T_J = 150^\circ\text{C}$
I_{GSS}	Gate-to-Source Forward Leakage	—	—	100	nA	$V_{GS} = 20V$
	Gate-to-Source Reverse Leakage	—	—	-100		$V_{GS} = -20V$
Q_g	Total Gate Charge	—	—	123	nC	$I_D = 18A$
Q_{gs}	Gate-to-Source Charge	—	—	21		$V_{DS} = 160V$
Q_{gd}	Gate-to-Drain ("Miller") Charge	—	—	57		$V_{GS} = 10V$, See Fig. 6 and 13 ④
$t_{d(on)}$	Turn-On Delay Time	—	14	—	ns	$V_{DD} = 100V$
t_r	Rise Time	—	43	—		$I_D = 18A$
$t_{d(off)}$	Turn-Off Delay Time	—	41	—		$R_G = 3.9\Omega$
t_f	Fall Time	—	33	—		$R_D = 5.5\Omega$, See Fig. 10 ④
L_D	Internal Drain Inductance	—	4.5	—	nH	Between lead, 6mm (0.25in.) from package and center of die contact
L_S	Internal Source Inductance	—	7.5	—		
C_{iss}	Input Capacitance	—	2159	—	pF	$V_{GS} = 0V$
C_{oss}	Output Capacitance	—	315	—		$V_{DS} = 25V$
C_{rss}	Reverse Transfer Capacitance	—	83	—		$f = 1.0\text{MHz}$, See Fig. 5

Source-Drain Ratings and Characteristics

	Parameter	Min.	Typ.	Max.	Units	Conditions
I_S	Continuous Source Current (Body Diode)	—	—	30	A	MOSFET symbol showing the integral reverse p-n junction diode.
I_{SM}	Pulsed Source Current (Body Diode)①	—	—	120		
V_{SD}	Diode Forward Voltage	—	—	1.3	V	$T_J = 25^\circ\text{C}, I_S = 18A, V_{GS} = 0V$ ④
t_{rr}	Reverse Recovery Time	—	186	279	ns	$T_J = 25^\circ\text{C}, I_F = 18A$
Q_{rr}	Reverse Recovery Charge	—	1.3	2.0	μC	$di/dt = 100A/\mu s$ ④
t_{on}	Forward Turn-On Time	Intrinsic turn-on time is negligible (turn-on is dominated by L_S+L_D)				

Notes:

- ① Repetitive rating; pulse width limited by max. junction temperature. (See Fig. 11)
- ② Starting $T_J = 25^\circ\text{C}$, $L = 1.9\text{mH}$, $R_G = 25\Omega$, $I_{AS} = 18A$. (See Figure 12)
- ③ $I_{SD} \leq 18A$, $di/dt \leq 374A/\mu s$, $V_{DD} \leq V_{(BR)DSS}$, $T_J \leq 175^\circ\text{C}$
- ④ Pulse width $\leq 300\mu s$; duty cycle $\leq 2\%$.

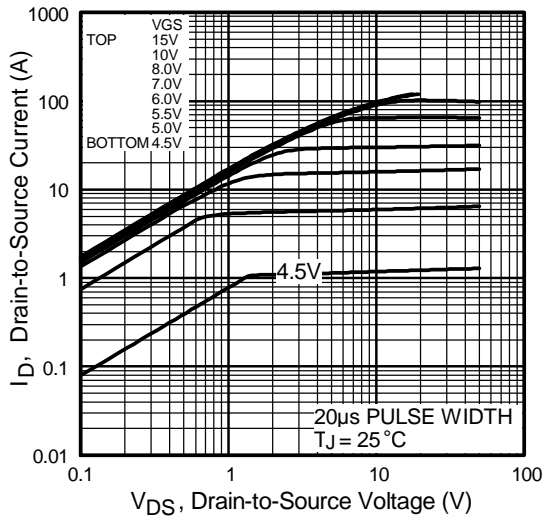

Fig 1. Typical Output Characteristics

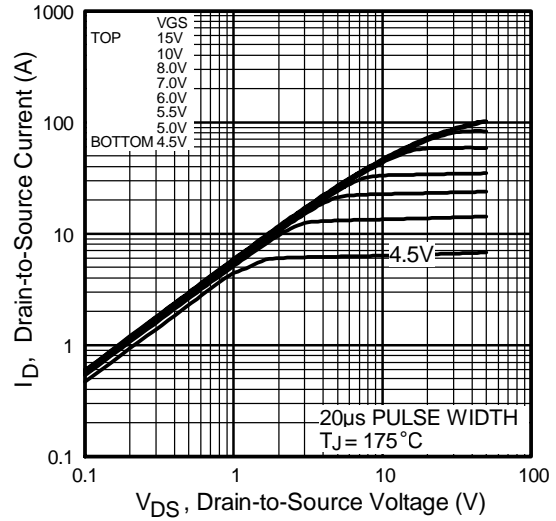

Fig 2. Typical Output Characteristics

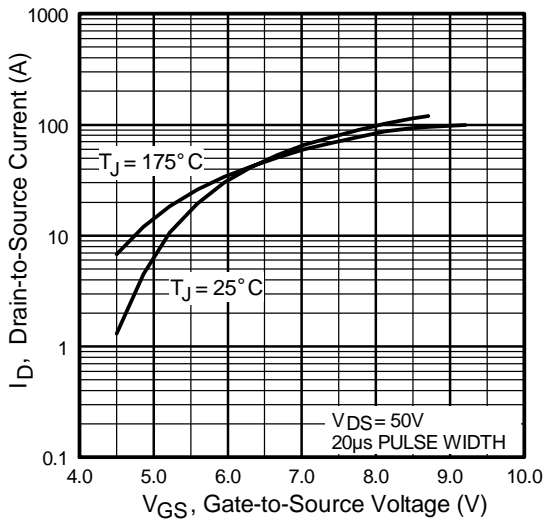

Fig 3. Typical Transfer Characteristics

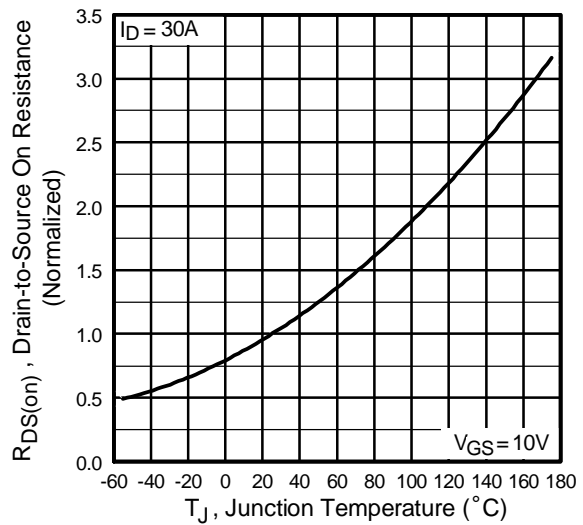

Fig 4. Normalized On-Resistance Vs. Temperature

IRFP250N

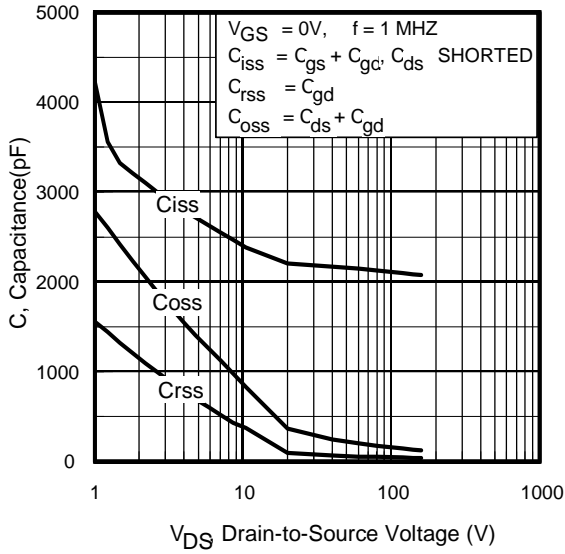

Fig 5. Typical Capacitance Vs. Drain-to-Source Voltage

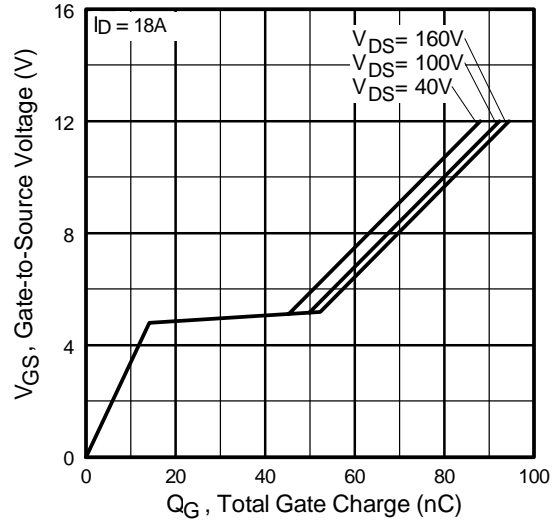

Fig 6. Typical Gate Charge Vs. Gate-to-Source Voltage

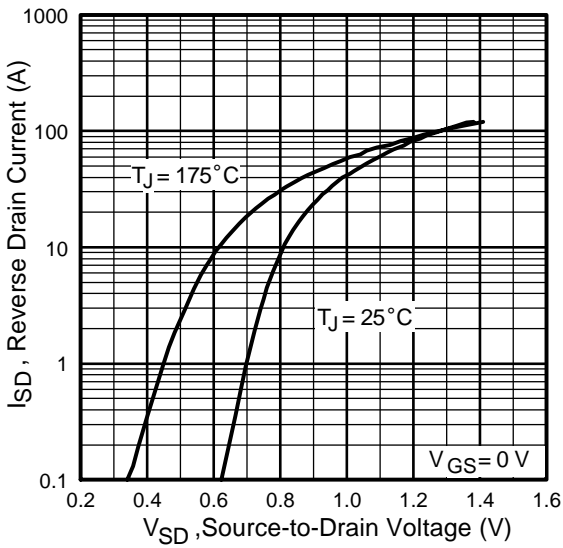

Fig 7. Typical Source-Drain Diode Forward Voltage

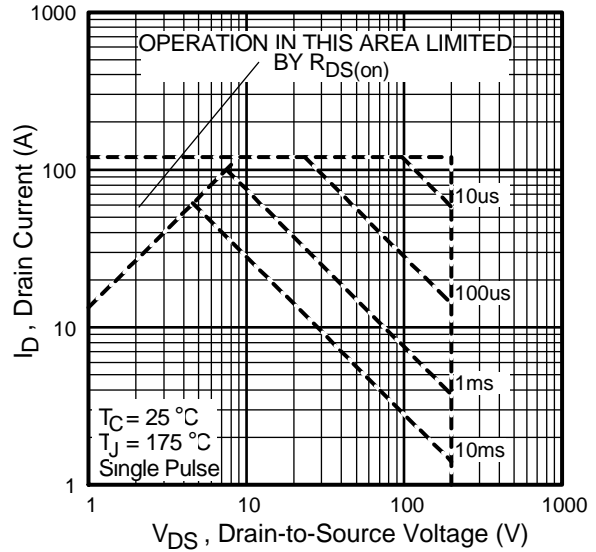

Fig 8. Maximum Safe Operating Area

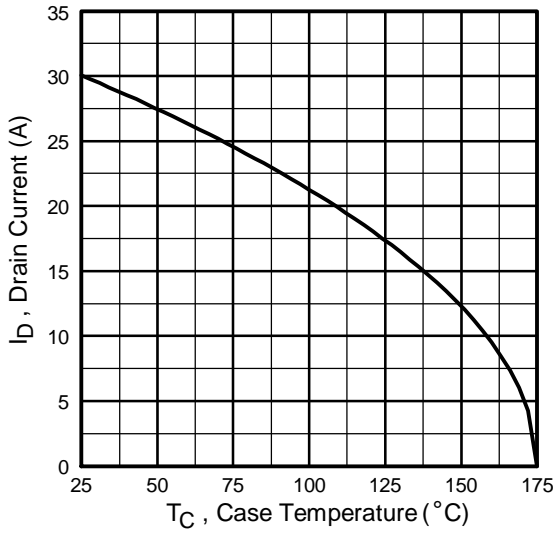

Fig 9. Maximum Drain Current Vs. Case Temperature

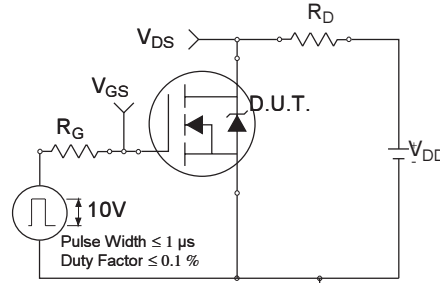

Fig 10a. Switching Time Test Circuit

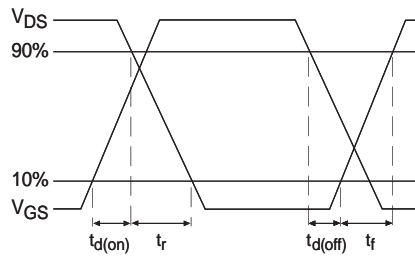

Fig 10b. Switching Time Waveforms

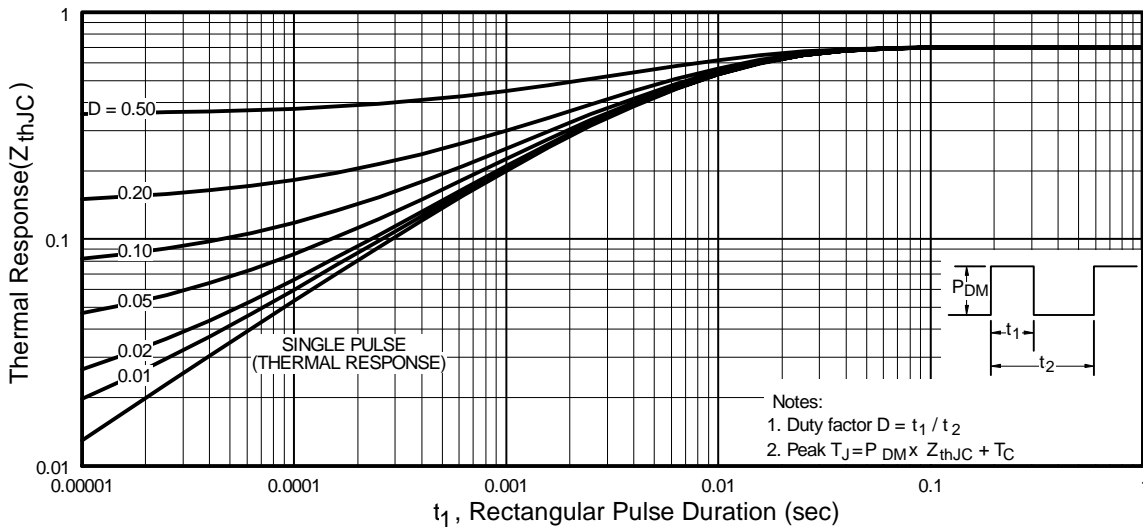

Fig 11. Maximum Effective Transient Thermal Impedance, Junction-to-Case

IRFP250N

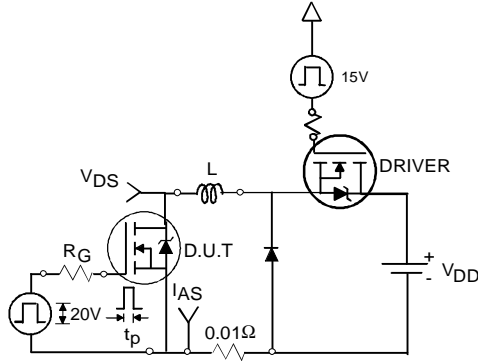

Fig 12a. Unclamped Inductive Test Circuit



Fig 12b. Unclamped Inductive Waveforms

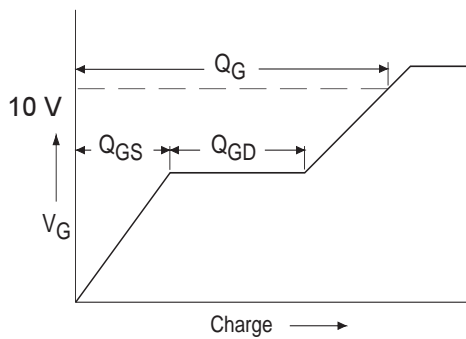

Fig 13a. Basic Gate Charge Waveform

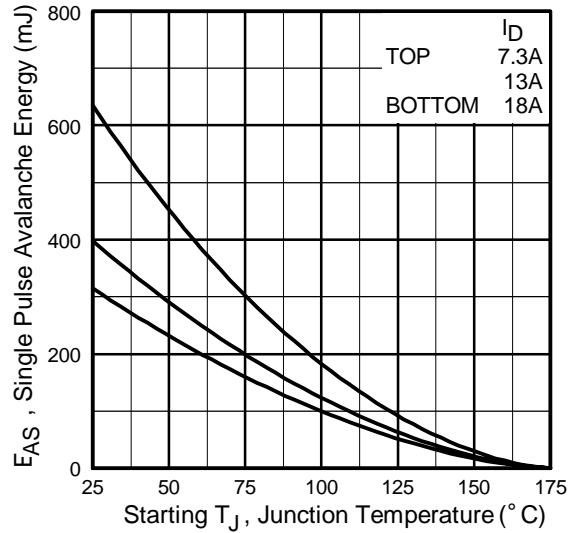

Fig 12c. Maximum Avalanche Energy Vs. Drain Current

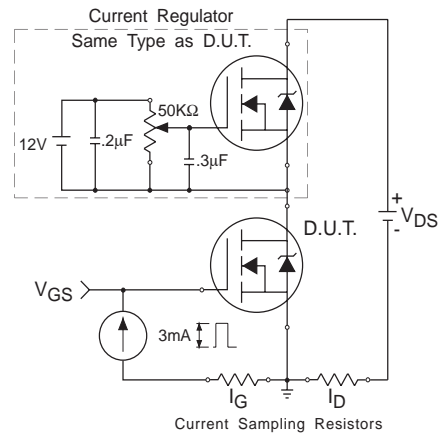
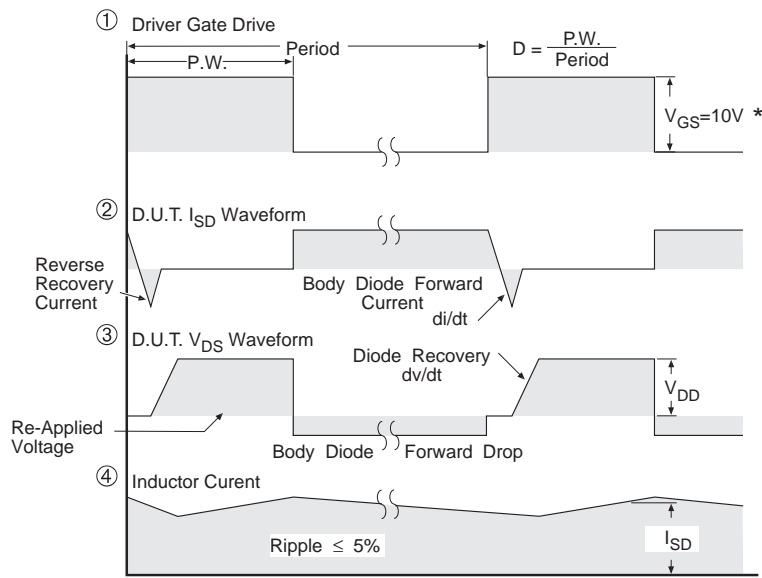

Fig 13b. Gate Charge Test Circuit

Peak Diode Recovery dv/dt Test Circuit



* $V_{GS} = 5V$ for Logic Level Devices

Fig 14. For N-Channel HEXFETS

IRFP250N

International
IR Rectifier

TO-247AC Package Outline Dimensions are shown in millimeters (inches)

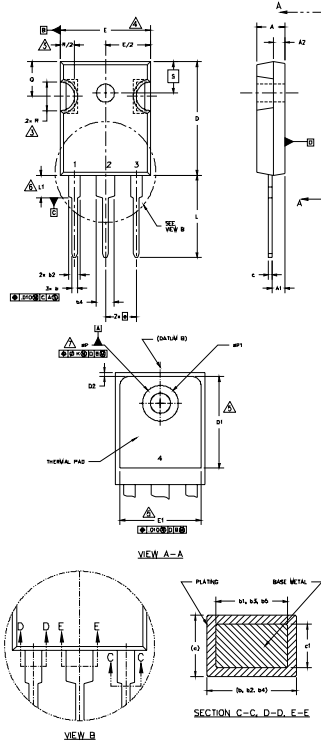

NOTES:

1. DIMENSIONING AND TOLERANCING PER ASME Y14.5M 1994.
2. DIMENSIONS ARE SHOWN IN INCHES [MILLIMETERS]

△ CONTOUR OF SLOT OPTIONAL.

△ DIMENSION D & E DO NOT INCLUDE MOLD FLASH. MOLD FLASH SHALL NOT EXCEED .005" (0.127) PER SIDE. THESE DIMENSIONS ARE MEASURED AT THE OUTERMOST EXTREMES OF THE PLASTIC BODY.

△ THERMAL PAD CONTOUR OPTIONAL WITHIN DIMENSIONS D1 & E1.

△ LEAD FINISH UNCONTROLLED IN L1.

△ φP TO HAVE A MAXIMUM DRAFT ANGLE OF 1.5° TO THE TOP OF THE PART WITH A MAXIMUM HOLE DIAMETER OF .154" [3.91]

B. OUTLINE CONFORMS TO JEDEC OUTLINE TO-247 WITH THE EXCEPTION OF DIMENSION C.

SYMBOL	DIMENSIONS				NOTES
	INCHES		MILLIMETERS		
A	.183	.209	4.65	5.31	
A1	.087	.102	2.21	2.59	
A2	.059	.098	1.50	2.49	
b	.039	.055	0.99	1.40	
b1	.039	.053	0.99	1.35	
b2	.065	.094	1.65	2.39	
b3	.065	.092	1.65	2.37	
b4	.102	.135	2.59	3.43	
b5	.102	.133	2.59	3.38	
c	.015	.034	0.38	0.86	
cl	.015	.030	0.38	0.76	
D	.736	.815	19.21	20.70	4
D1	.515	-	13.08	-	5
D2	.020	.030	0.51	0.76	
E	.602	.625	15.29	15.87	4
E1	.540	-	13.72	-	
e	.215 BSC		5.46 BSC		
φK	.010		2.54		
L	.559	.634	14.20	16.10	
L1	.146	.169	3.71	4.29	
N	3		7.62 BSC		
φP	.140	.144	3.56	3.66	
φP1	-	.275	-	6.98	
O	.209	.224	5.31	5.69	
R	.178	.216	4.52	5.49	
S	.217 BSC		5.51 BSC		

LEAD ASSIGNMENTS

HEXFEET

- 1.- GATE
- 2.- DRAIN
- 3.- SOURCE
- 4.- DRAIN

UGB1s, CoPACK

- 1.- GATE
- 2.- COLLECTOR
- 3.- EMITTER
- 4.- COLLECTOR

DIODES

- 1.- ANODE/OPEN
- 2.- CATHODE
- 3.- ANODE

TO-247AC Part Marking Information

EXAMPLE: THIS IS AN IRFPE30
WITH ASSEMBLY
LOT CODE 5657
ASSEMBLED ON VVV 35, 2000
IN THE ASSEMBLY LINE "H"

Note: "P" in assembly line
position indicates "Lead-Free"

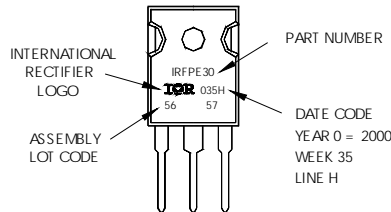

Data and specifications subject to change without notice.
This product has been designed and qualified for the Automotive [Q101] market.
Qualification Standards can be found on IR's Web site.

International
IR Rectifier

IR WORLD HEADQUARTERS: 233 Kansas St., El Segundo, California 90245, USA Tel: (310) 252-7105
TAC Fax: (310) 252-7903

Visit us at www.irf.com for sales contact information. 10/04