

600V Half Bridge Driver
PRODUCT SUMMARY

- V_{OFFSET} 600 V max.
- $I_{\text{O}+/-}$ 130 mA/270 mA
- V_{OUT} 10 V - 20 V
- $t_{\text{on/off}}$ (typ.) 220 ns/200 ns
- **Deadtime** (typ.) none

GENERAL DESCRIPTION

The SLM2106S is a high voltage, high speed power MOSFET and IGBT drivers with dependent high- and low-side referenced output channels. Proprietary HVIC and latch immune CMOS technologies enable ruggedized monolithic construction. The logic input is compatible with standard CMOS or LSTTL output, down to 3.3 V logic. The output drivers feature a high pulse current buffer stage designed for minimum driver cross conduction. The floating channel can be used to drive an N-channel power MOSFET or IGBT in the high-side configuration which operates up to 600 V.

FEATURES

- Floating channel designed for bootstrap operation
- Fully operational to +600 V
- Tolerant to negative transient voltage, dV/dt immune
- Gate drive supply range from 10 V to 20 V
- Undervoltage lockout for both channels
- 3.3 V, 5 V, and 15 V logic compatible
- Matched propagation delay for both channels
- Logic and power ground +/- 5 V offset
- Lower di/dt gate driver for better noise immunity
- Outputs in phase with inputs
- RoHS compliant
- SOIC8 and DIP8 package
- SOIC-14 package

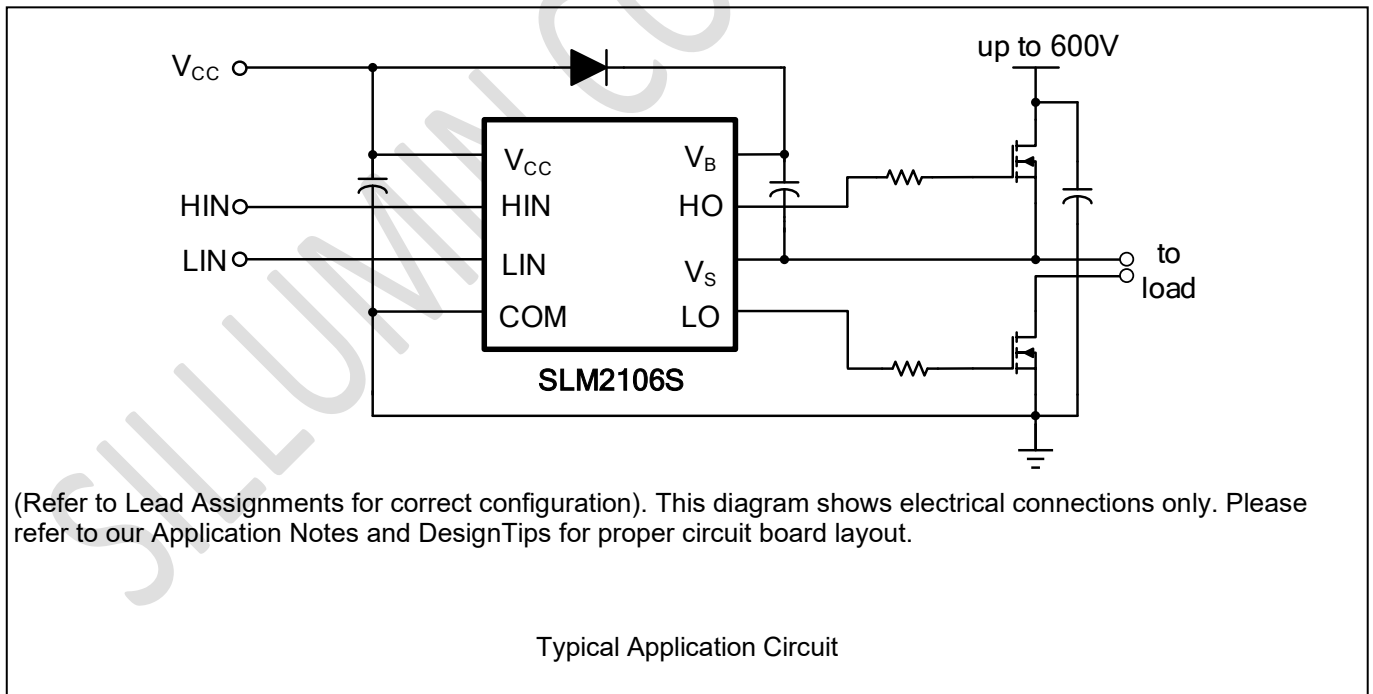
TYPICAL APPLICATION CIRCUIT

PIN CONFIGURATION

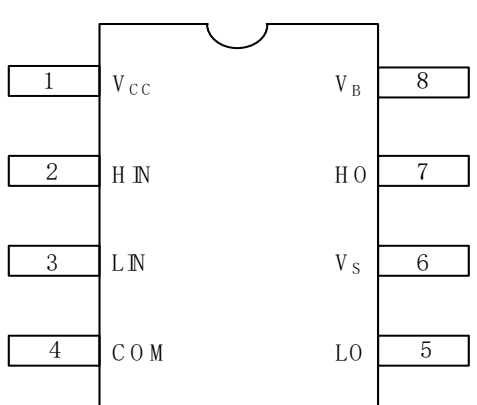
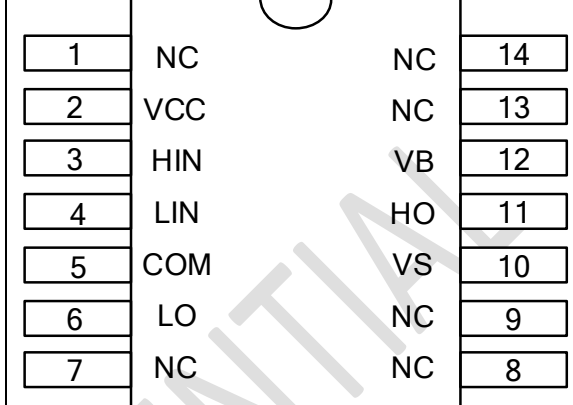
Package	SOIC-8 and PDIP-8	SOIC-14
Pin Configuration (Top View)		

PIN DESCRIPTION

No.		Pin	Description
SOIC-8 and PDIP-8	SOIC-14		
1	2	V _{CC}	Low-side and logic fixed supply
2	3	HIN	Logic input for high-side gate driver output (HO), in phase
3	4	LIN	Logic input for low-side gate driver output (LO), in phase
4	5	COM	Low-side return
5	6	LO	Low-side gate drive output
6	10	V _S	High-side floating supply return
7	11	HO	High-side gate drive output
8	12	V _B	High-side floating supply
	1,7,8,9,13,14	NC	Floating, no internal connection

ORDERING INFORMATION
Industrial Range: -40°C to +125°C

Order Part No.	Package	QTY
SLM2106SCA-13GTR	SOIC8, Pb-Free	2500/Reel
SLM2106SCA-GT	SOIC8, Pb-Free	100/Tube
SLM2106SDA-GT	PDIP8, Pb-Free	100/Tube
SLM2106SCJ-13GTR	SOIC14, Pb-Free	4000/Reel

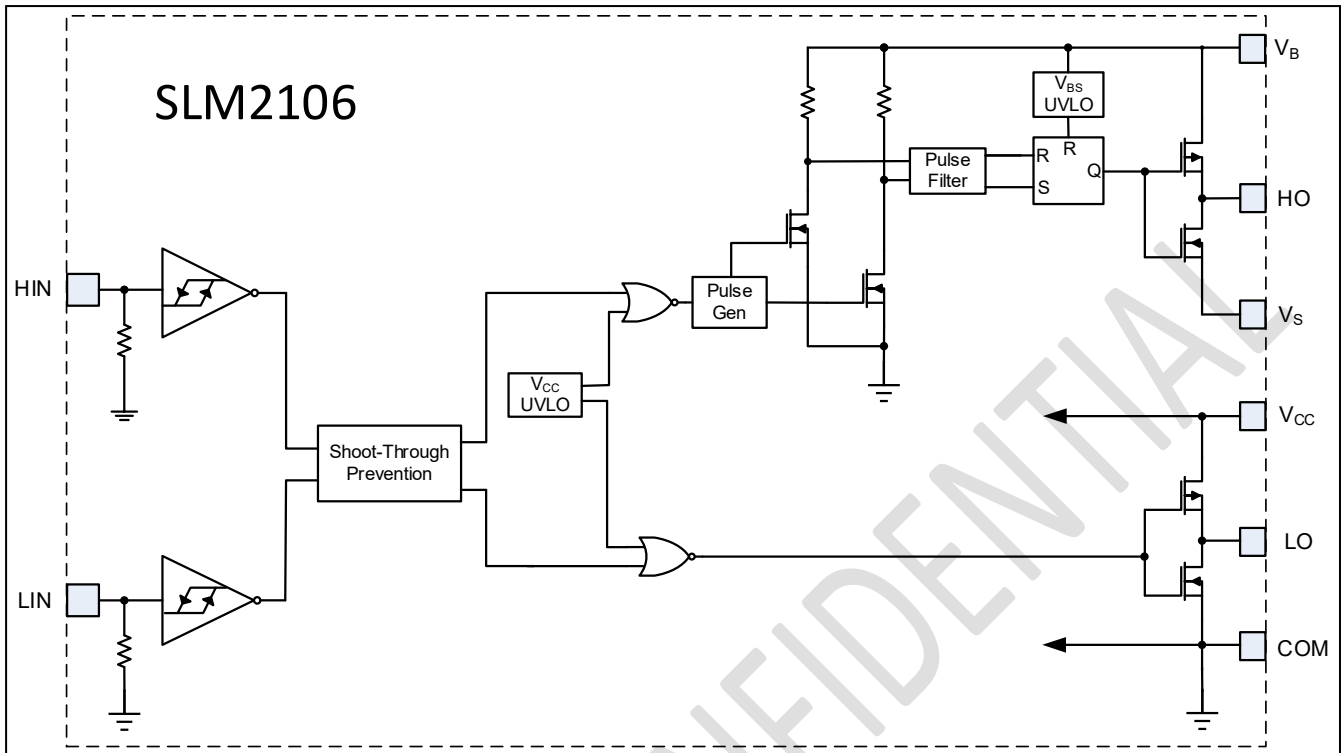
FUNCTIONAL BLOCK DIAGRAM

ABSOLUTE MAXIMUM RATINGS

Symbol	Definition	Min.	Max.	Units	
V _B	High-side floating absolute voltage	-0.3	625	V	
V _S	High-side floating supply offset voltage	V _B - 25	V _B + 0.3		
V _{HO}	High-side floating output voltage	V _S - 0.3	V _B + 0.3		
V _{CC}	Low-side and logic fixed supply voltage	-0.3	25		
V _{LO}	Low-side output voltage	-0.3	V _{CC} + 0.3		
V _{IN}	Logic input voltage (HIN & $\overline{\text{LIN}}$)	-0.3	V _{CC} + 0.3		
dV _S /dt	Allowable offset supply voltage transient	---	50	V/ns	
P _D	Package power dissipation @ T _A ≤ +25°C	PDIP-8	---	1.0	W
		SOIC-8	---	0.625	
		SOIC-14	---	0.892	
R _{thJA}	Thermal resistance, junction to ambient	PDIP-8	---	125	°C/W
		SOIC-8	---	200	
		SOIC-14	---	140	
T _J	Junction temperature	---	150	°C	
T _S	Storage temperature	-55	150		
T _L	Lead temperature (soldering, 10 seconds)	---	300		

Note:

Absolute maximum ratings indicate sustained limits beyond which damage to the device may occur. All voltage parameters are absolute voltages referenced to COM. The thermal resistance and power dissipation ratings are measured under board mounted and still air conditions.

RECOMMENDED OPERATING CONDITIONS

Symbol	Definition	Min.	Max.	Units
V _B	High-side floating absolute voltage	V _S + 10	V _S + 20	V
V _S	High-side floating supply offset voltage	Note 1	600	
V _{HO}	High-side floating output voltage	V _S	V _B	
V _{CC}	Low-side and logic fixed supply voltage	10	20	
V _{LO}	Low-side output voltage	0	V _{CC}	
V _{IN}	Logic input voltage	V _{SS}	V _{CC}	
T _A	Ambient temperature	- 40	125	°C

Note:

The input/output logic timing diagram is shown in Fig. 1. For proper operation the device should be used within the recommended conditions. The V_S offset rating is tested with all supplies biased at a 15 V differential.

DYNAMIC ELECTRICAL CHARACTERISTICS
 $V_{BIAS} (V_{CC}, V_{BS}) = 15\text{ V}$, $C_L = 1000\text{ pF}$ and $T_A = 25^\circ\text{C}$ unless otherwise specified.

Symbol	Parameter	Condition	Min.	Typ.	Max.	Unit
t_{on}	Turn-on propagation delay	$V_S = 0\text{ V}$	---	220	300	ns
t_{off}	Turn-off propagation delay	$V_S = 0\text{ V}$ or 600 V	---	200	280	
t_r	Turn-on rise time	$V_S = 0\text{ V}$	---	100	220	
t_f	Turn-off fall time		---	35	80	
MT	Delay matching, HS & LS turn-on/off		---	0	30	

STATIC ELECTRICAL CHARACTERISTICS
 $V_{BIAS} (V_{CC}, V_{BS}) = 15\text{ V}$ and $T_A = 25^\circ\text{C}$ unless otherwise specified. The V_{IN} , V_{TH} , and I_{IN} parameters are referenced to COM. The V_O and I_O parameters are referenced to COM and are applicable to the respective output leads: HO or LO.

Symbol	Parameter	Condition	Min	Typ.	Max.	Unit
V_{IH}	Logic "1" input voltage	$V_{CC} = 10\text{ V}$ to 20 V	2.5	---	---	V
V_{IL}	Logic "0" input voltage		---	---	0.8	
V_{OH}	High level output voltage, $V_{BIAS} - V_O$	$I_O = 2\text{ mA}$	---	0.05	0.2	
V_{OL}	Low level output voltage, V_O		---	0.02	0.1	
I_{LK}	Offset supply leakage current	$V_B = V_S = 600\text{ V}$	---	---	50	μA
I_{QBS}	Quiescent V_{BS} supply current	$V_{IN} = 0\text{ V}$ or 5 V	20	75	130	
I_{QCC}	Quiescent V_{CC} supply current		60	120	180	
I_{IN+}	Logic "1" input bias current $V_{IN} = 5\text{ V}$		---	5	20	
I_{IN-}	Logic "0" input bias current $V_{IN} = 0\text{ V}$		---	---	5	
V_{CCUV+} V_{BSUV+}	V_{CC} and V_{BS} supply undervoltage positive going threshold		8.0	8.9	9.8	V
V_{CCUV-} V_{BSUV-}	V_{CC} and V_{BS} supply undervoltage negative going threshold		7.4	8.2	9.0	
I_{O+}	Output high short circuit pulsed current	$V_O = 0\text{ V}$, $PW \leq 10\text{ }\mu\text{s}$	130	290		mA
I_{O-}	Output low short circuit pulsed current	$V_O = 15\text{ V}$, $PW \leq 10\text{ }\mu\text{s}$	270	600		

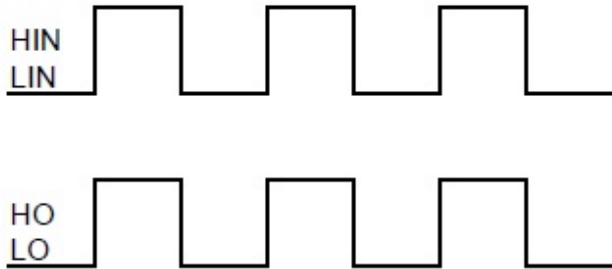

Figure 1. Input/Output Timing Diagram

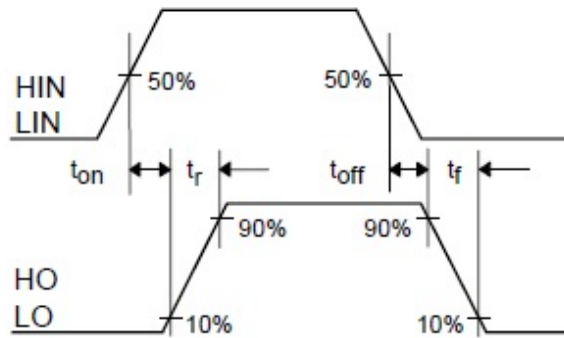

Figure 2. Switching Time Waveform Definitions

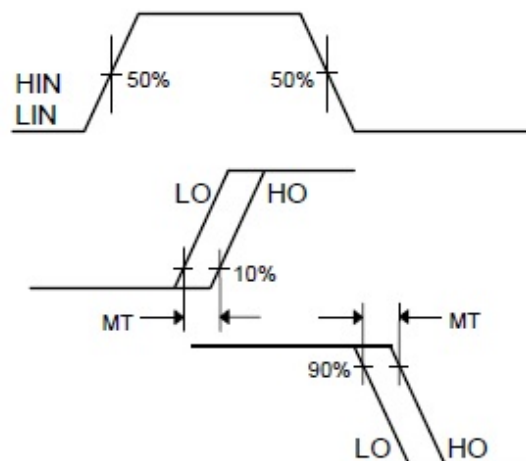

Figure 3. Delay Matching Waveform Definitions

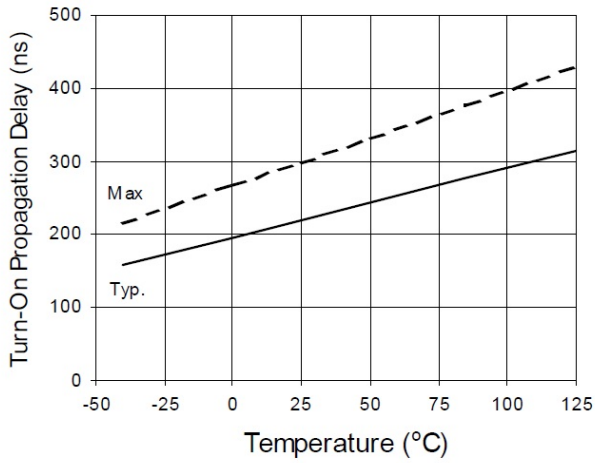

Figure 4A. Turn-On Propagation Delay vs. Temperature

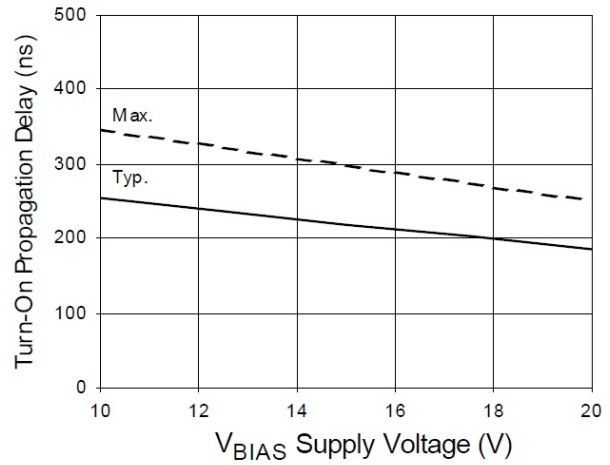

Figure 4B. Turn-On Propagation Delay vs. Supply Voltage

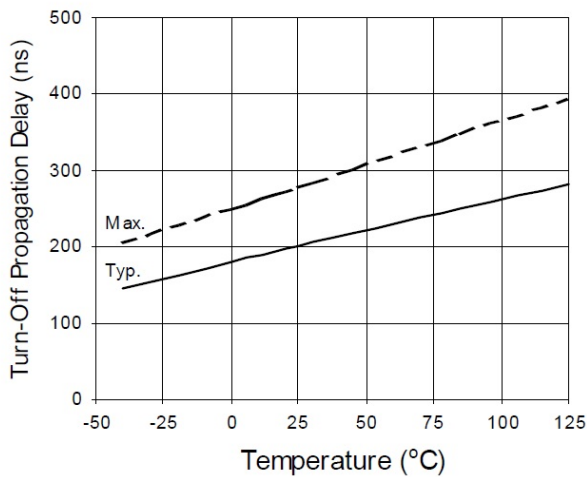

Figure 5A. Turn-Off Propagation Delay vs. Temperature

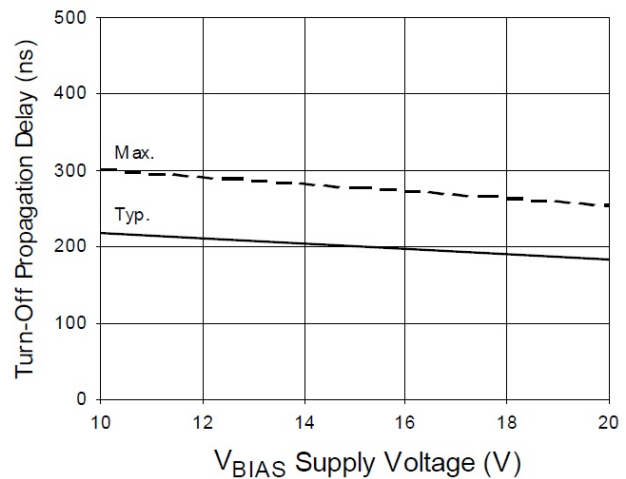

Figure 5B. Turn-Off Propagation Delay vs. Supply Voltage

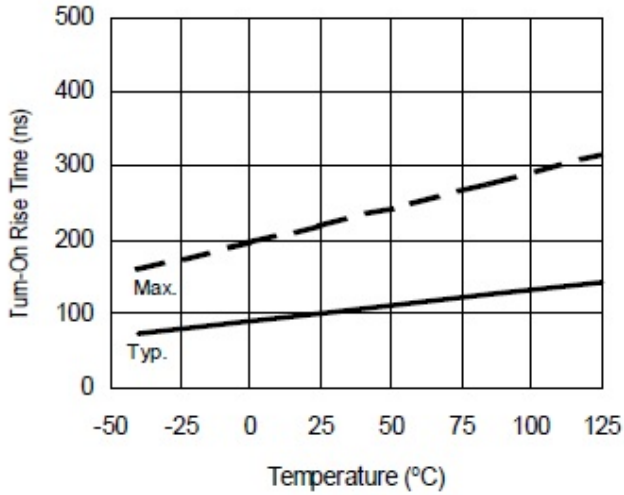

Figure 6A. Turn-On Rise Time vs. Temperature

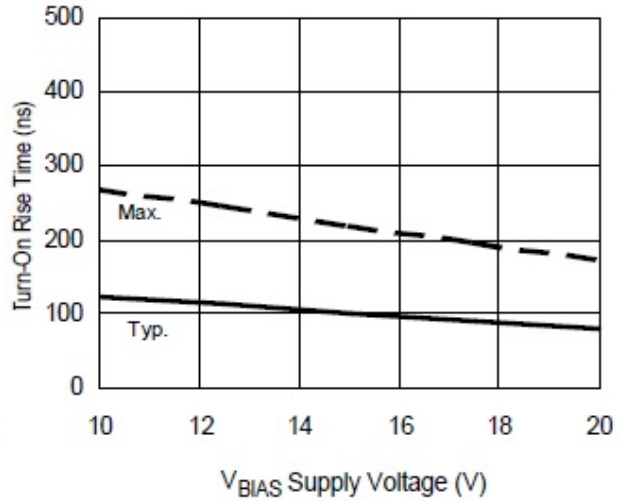

Figure 6B. Turn-On Rise Time vs. Supply Voltage

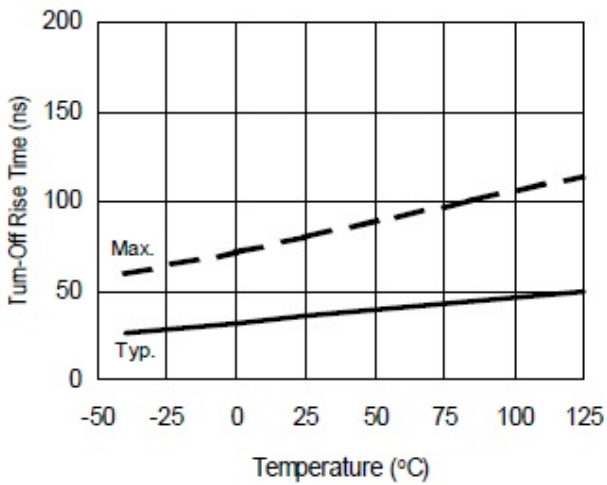

Figure 7A. Turn-Off Fall Time vs. Temperature

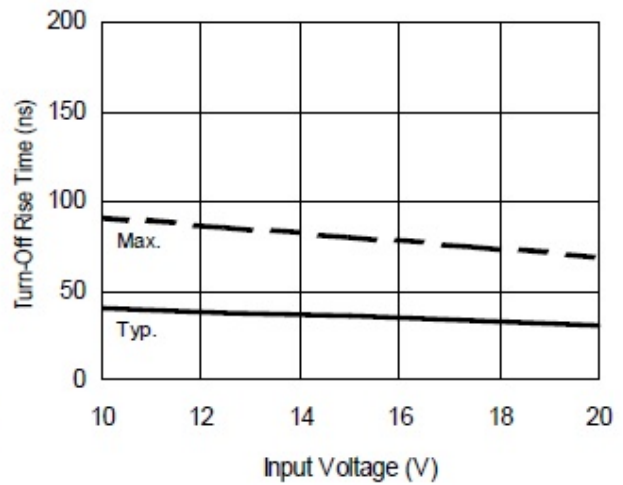

Figure 7B. Turn-Off Fall Time vs. Supply Voltage

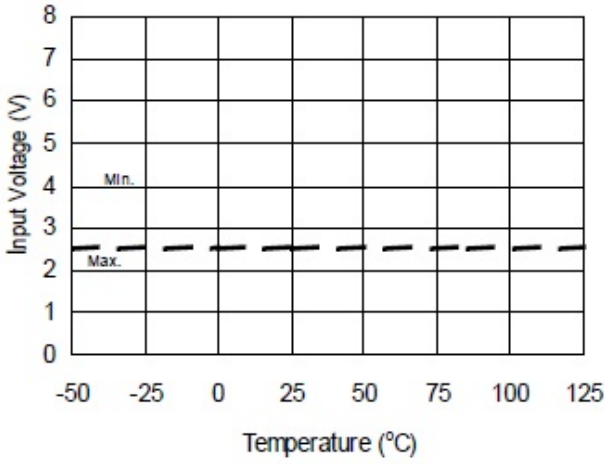

Figure 8A. Logic "1" Input Voltage vs. Temperature

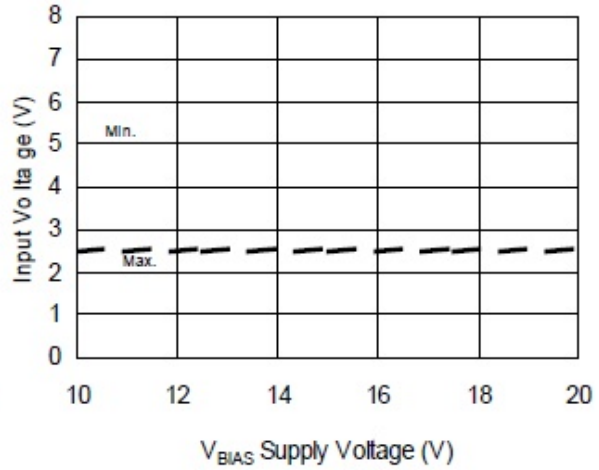

Figure 8B. Logic "1" Input Voltage vs. Supply Voltage

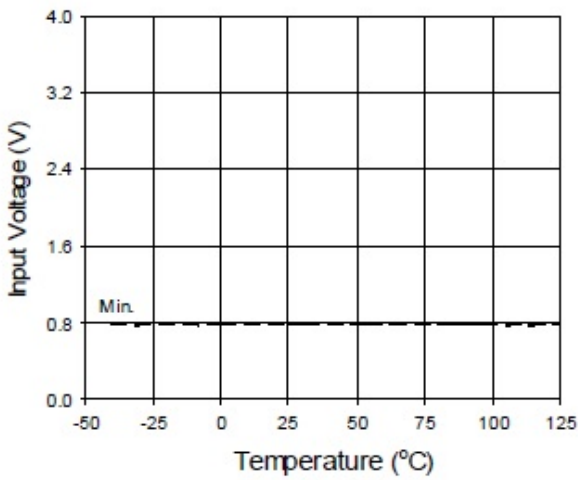

Figure 9A. Logic "0" Input Voltage vs. Temperature

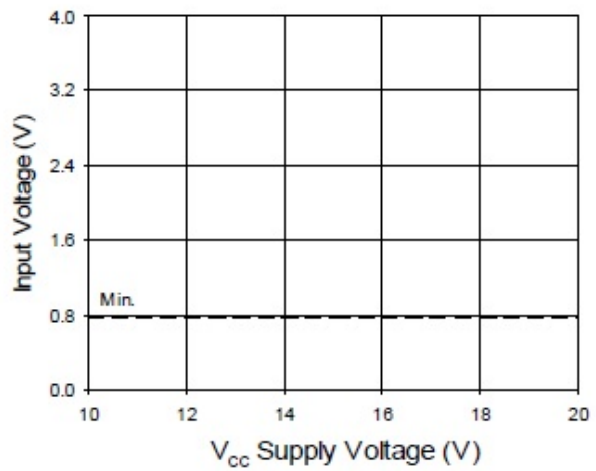

Figure 9B. Logic "0" Input Voltage vs. Supply Voltage

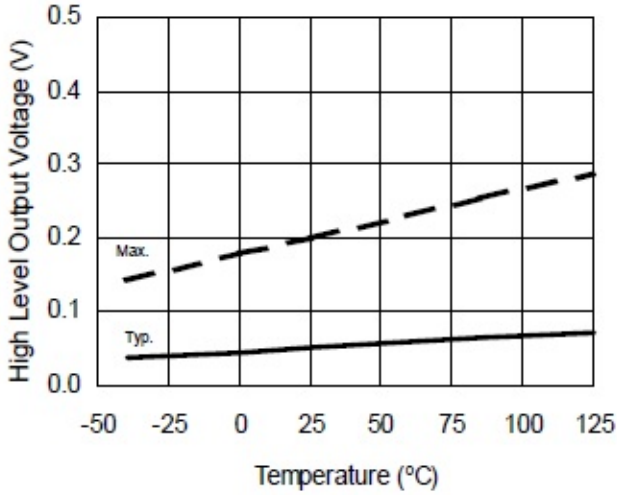

Figure 10A. High Level Output Voltage vs. Temperature

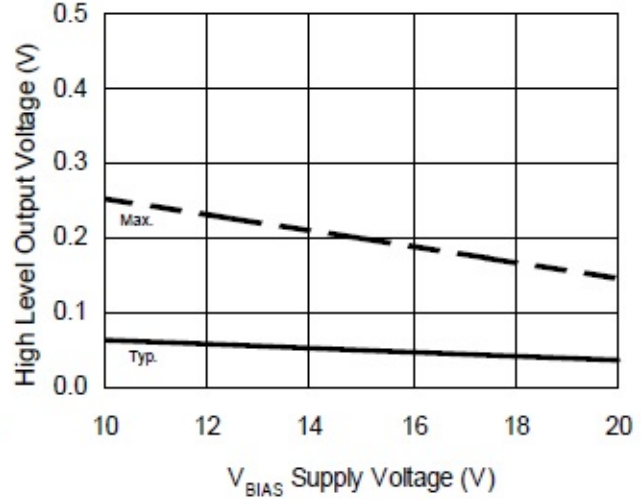

Figure 10B. High Level Output Voltage vs. Supply Voltage

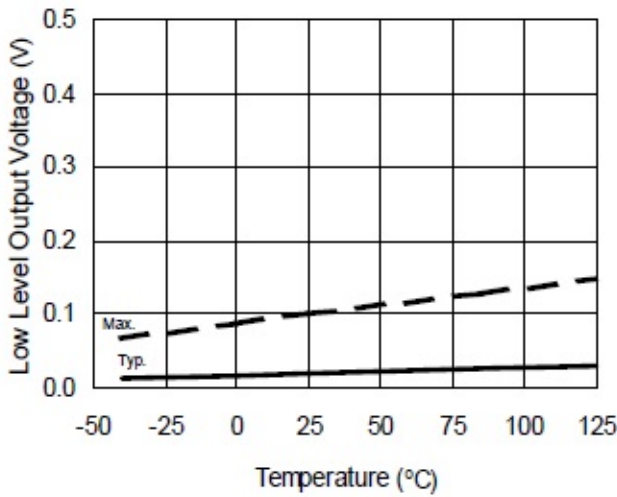

Figure 11A. Low Level Output Voltage vs. Temperature

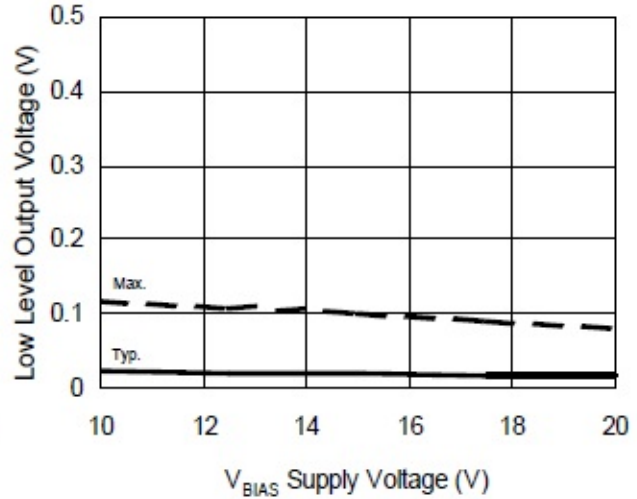

Figure 11B. Low Level Output Voltage vs. Supply Voltage

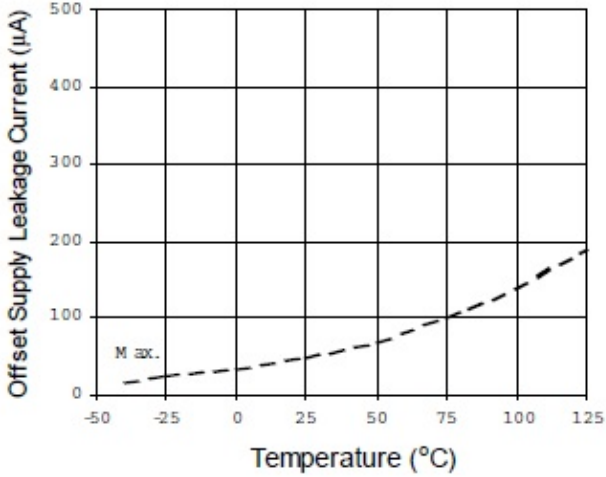

Figure 12A. Offset Supply Leakage Current vs. Temperature

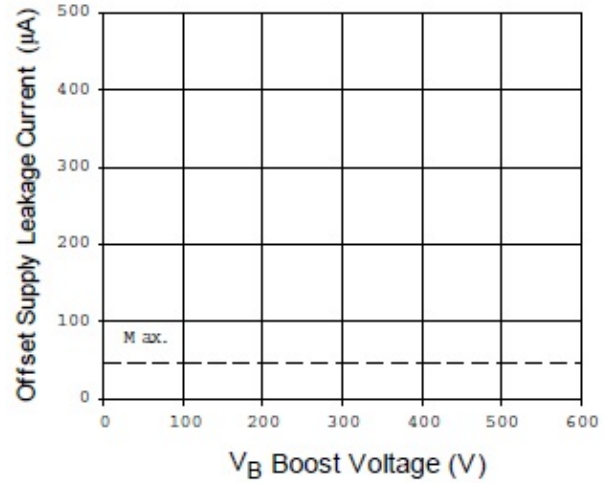

Figure 12B. Offset Supply Leakage Current vs. Supply Voltage

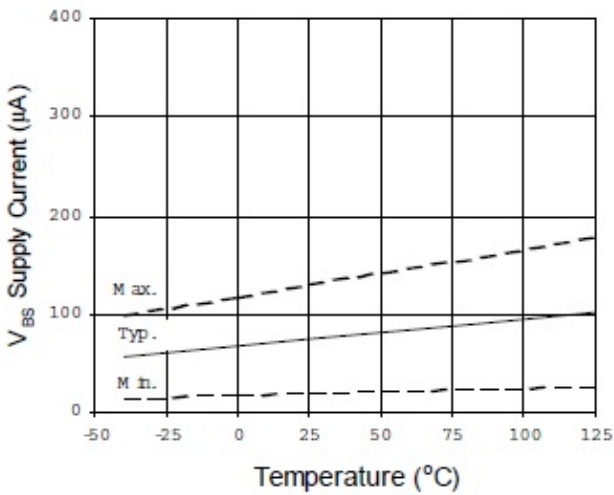

Figure 13A. VBS Supply Current vs. Temperature

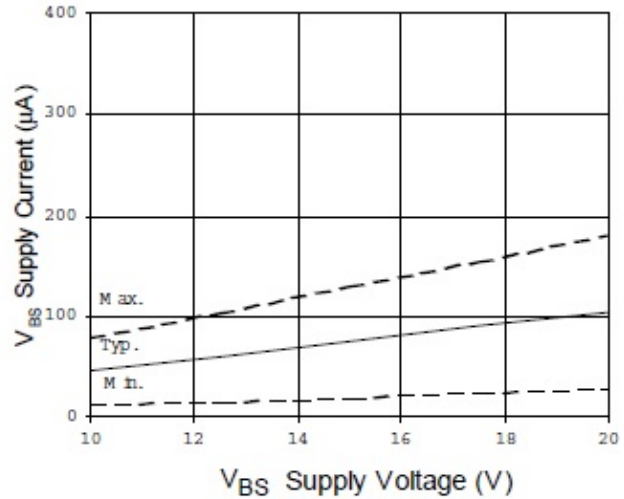

Figure 13B. VBS Supply Current vs. Supply Voltage

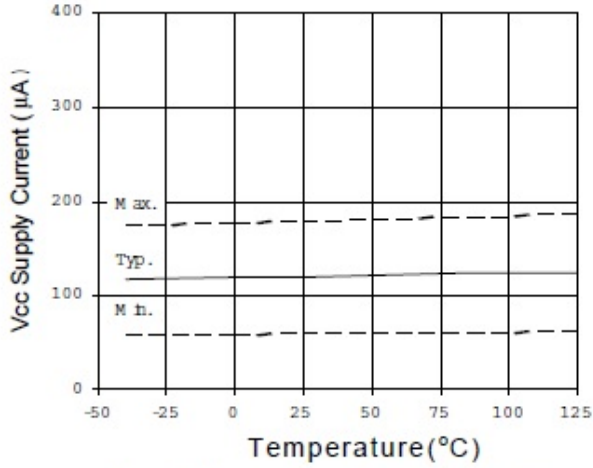

Figure 14A. Quiescent V_{CC} Supply Current vs. Temperature

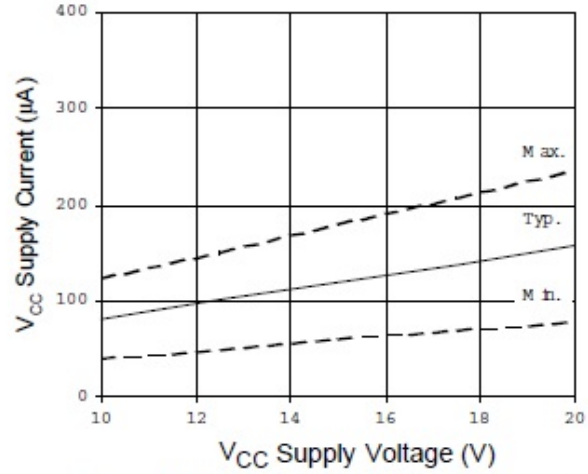

Figure 14B. Quiescent V_{CC} Supply Current vs. V_{CC} Supply Voltage

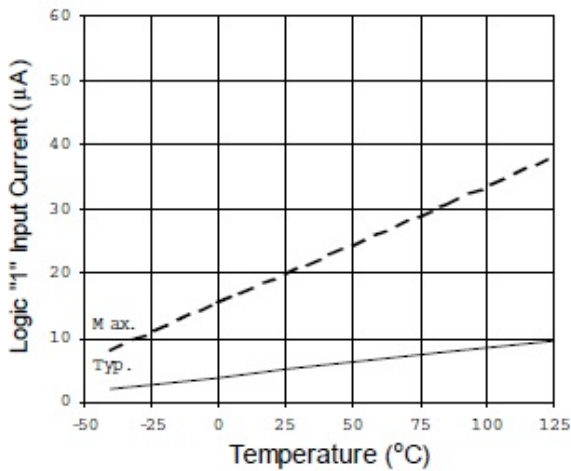

Figure 15A. Logic "1" Input Current vs. Temperature

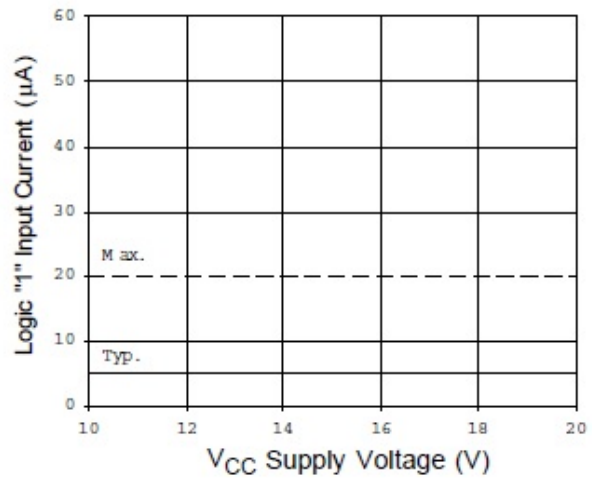

Figure 15B. Logic "1" Bias Current vs. Supply Voltage

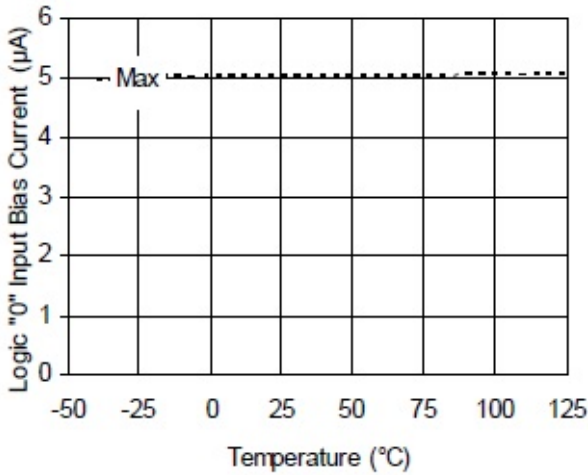

Figure 16A. Logic "0" Input Bias Current vs. Temperature

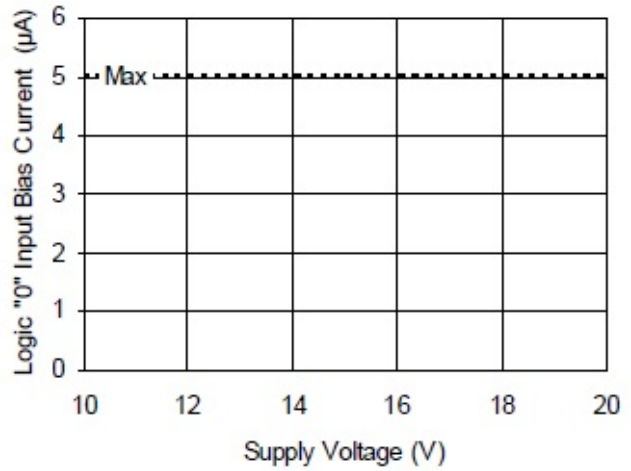

Figure 16B. Logic "0" Input Bias Current vs. Voltage

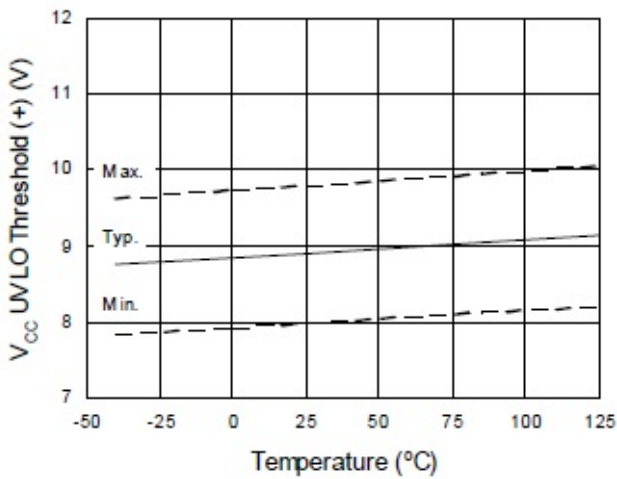

Figure 17. V_{CC} Undervoltage Threshold (+) vs. Temperature

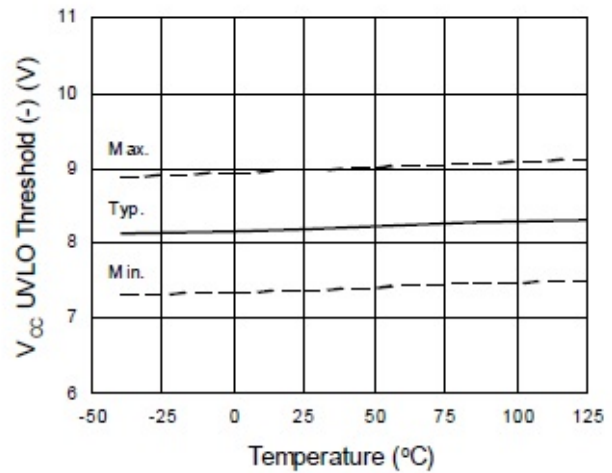

Figure 18. V_{CC} Undervoltage Threshold (-) vs. Temperature

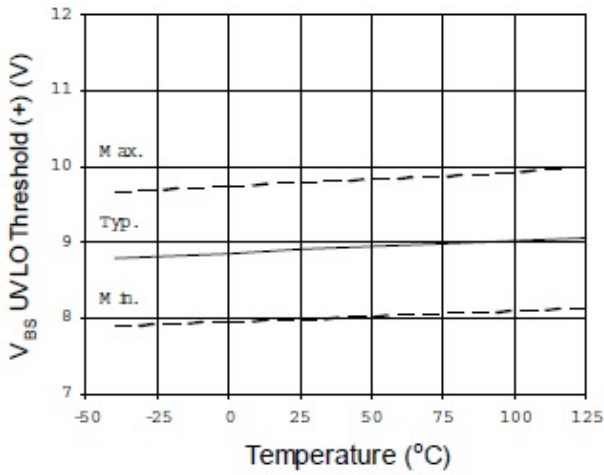

Figure 19. V_{BS} Undervoltage Threshold (+) vs. Temperature

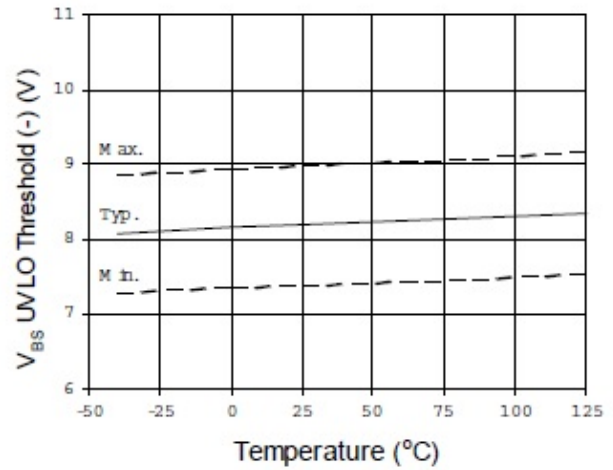

Figure 20. V_{BS} Undervoltage Threshold (-) vs. Temperature

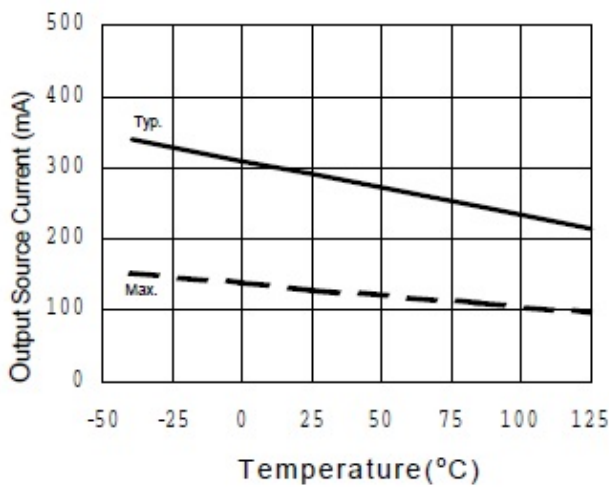

Figure 21A. Output Source Current vs. Temperature

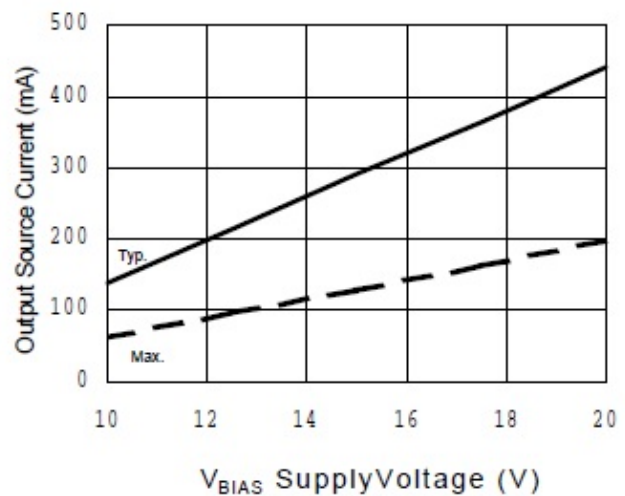

Figure 21B. Output Source Current vs. Supply Voltage

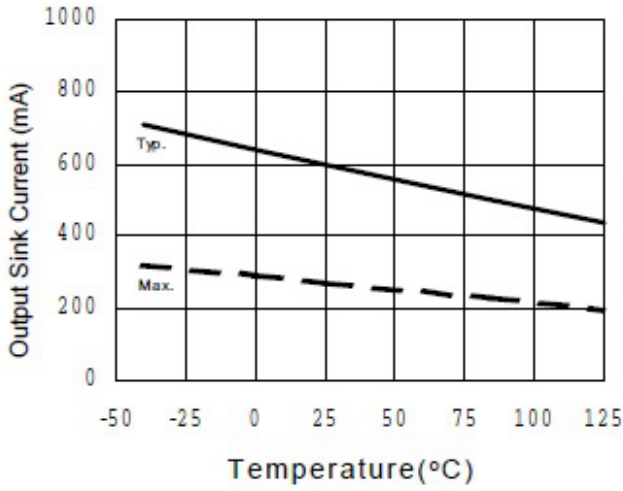

Figure 22A. Output Sink Current vs. Temperature

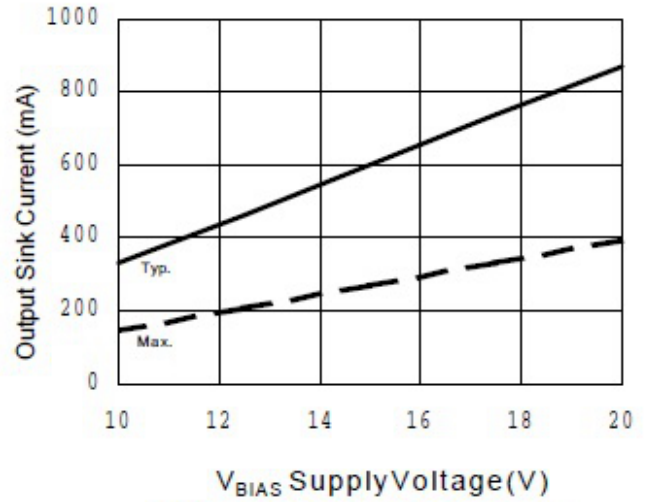

Figure 22B. Output Sink Current vs. Supply Voltage

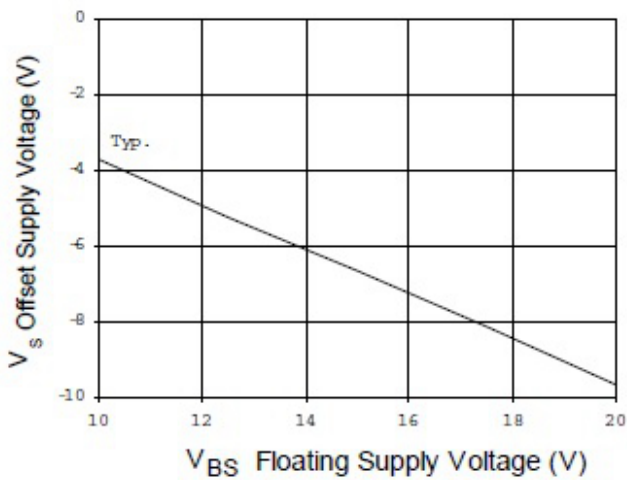
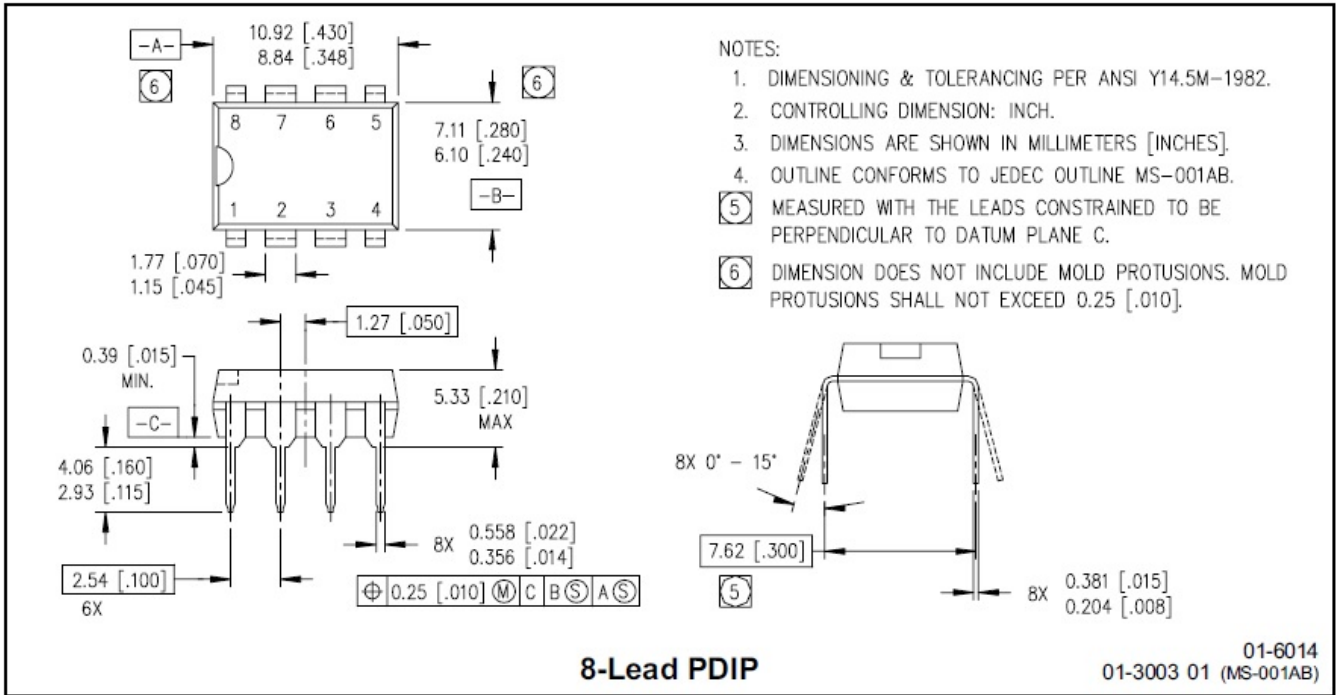
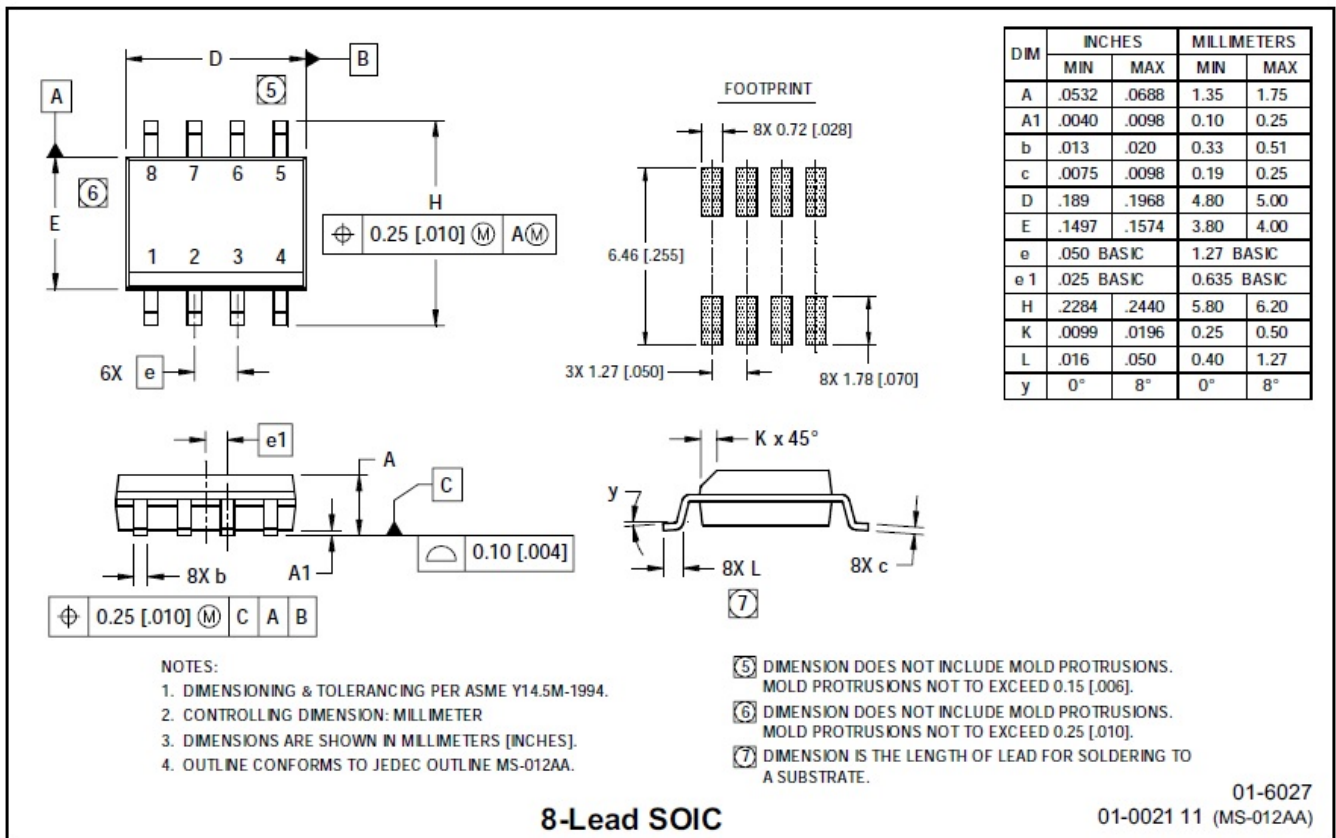

Figure 23. Maximum V_S Negative Offset vs. Supply Voltage

PACKAGE CASE OUTLINES



8-Lead PDIP



8-Lead SOIC

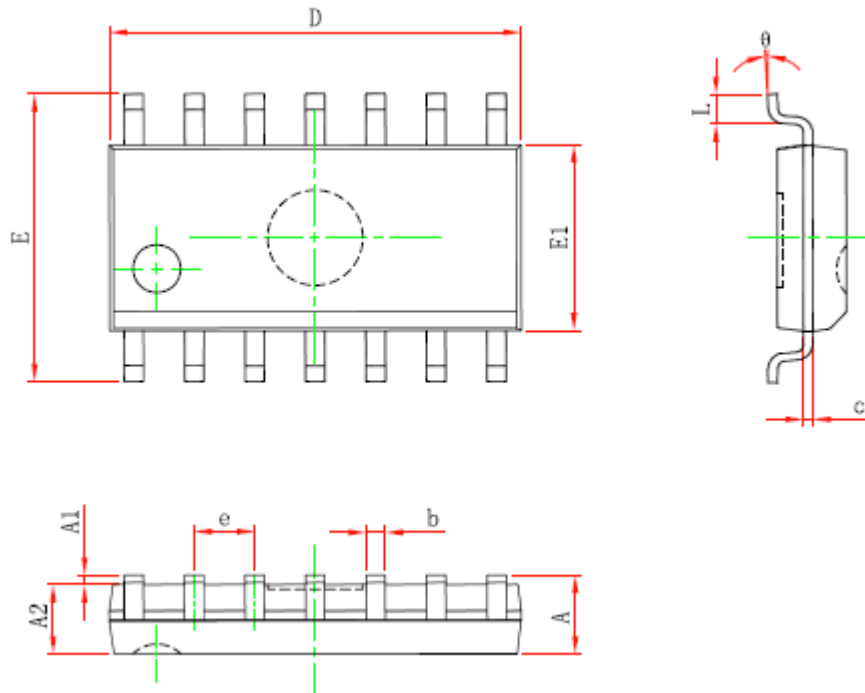

Symbol	Dimensions In Millimeters		Dimensions In Inches	
	Min	Max	Min	Max
A	—	1.750	—	0.069
A1	0.100	0.250	0.004	0.010
A2	1.250	—	0.049	—
b	0.310	0.510	0.012	0.020
c	0.100	0.250	0.004	0.010
D	8.450	8.850	0.333	0.348
E	5.800	6.200	0.228	0.244
E1	3.800	4.000	0.150	0.157
e	1.270(BSC)		0.050(BSC)	
L	0.400	1.270	0.016	0.050
θ	0°	8°	0°	8°

14-Lead SOIC
TAPE AND REEL INFORMATION

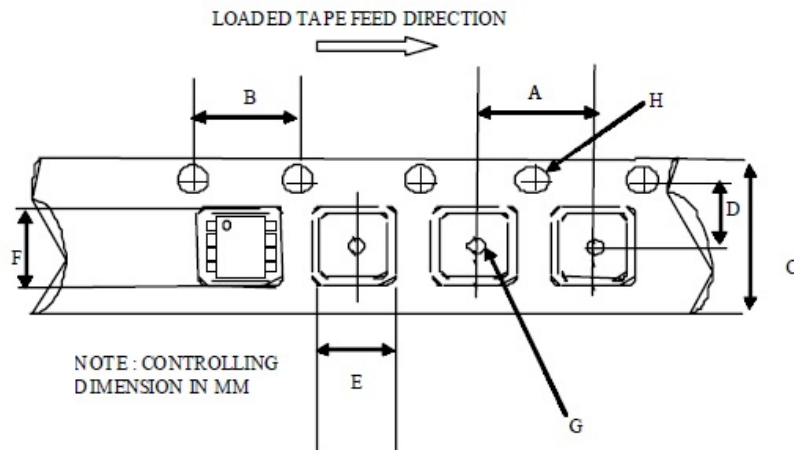
**Tape & Reel
8-lead SOIC**

CARRIER TAPE DIMENSION FOR 8SOICN

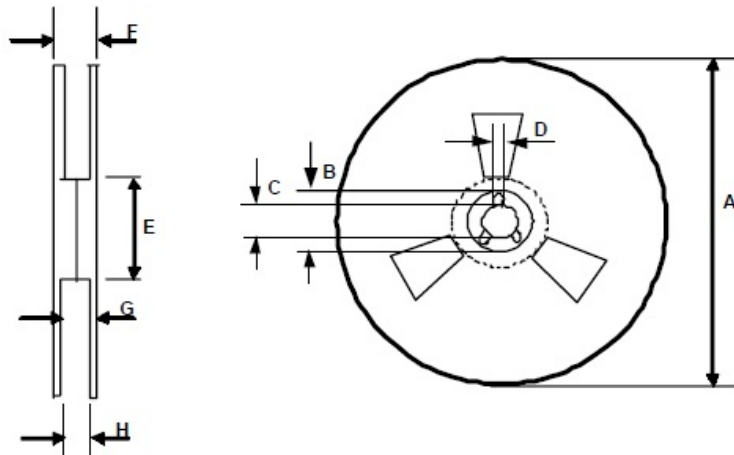
Code	Metric		Imperial	
	Min	Max	Min	Max
A	7.90	8.10	0.311	0.318
B	3.90	4.10	0.153	0.161
C	11.70	12.30	0.46	0.484
D	5.45	5.55	0.214	0.218
E	6.30	6.50	0.248	0.255
F	5.10	5.30	0.200	0.208
G	1.50	n/a	0.059	n/a
H	1.50	1.60	0.059	0.062

REEL DIMENSIONS FOR 8SOICN

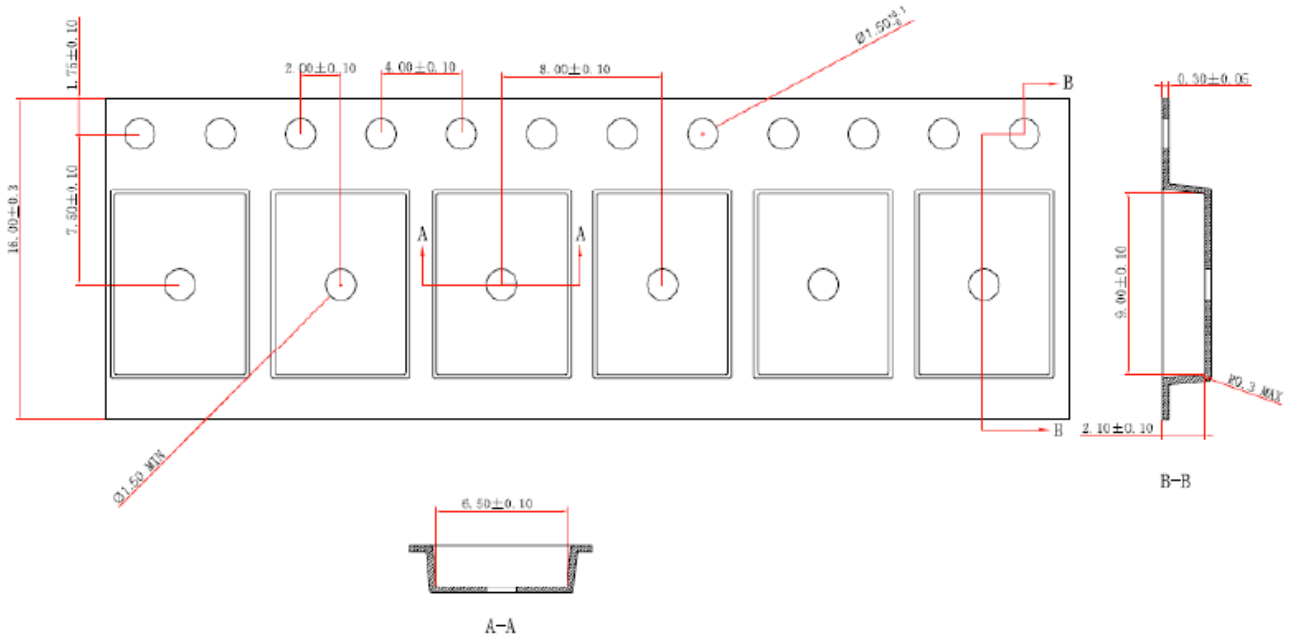
Code	Metric		Imperial	
	Min	Max	Min	Max
A	329.60	330.25	12.976	13.001
B	20.95	21.45	0.824	0.844
C	12.80	13.20	0.503	0.519
D	1.95	2.45	0.767	0.096
E	98.00	102.00	3.858	4.015
F	n/a	18.40	n/a	0.724
G	14.50	17.10	0.570	0.673
H	12.40	14.40	0.488	0.566



SOP14 卷盘尺寸:

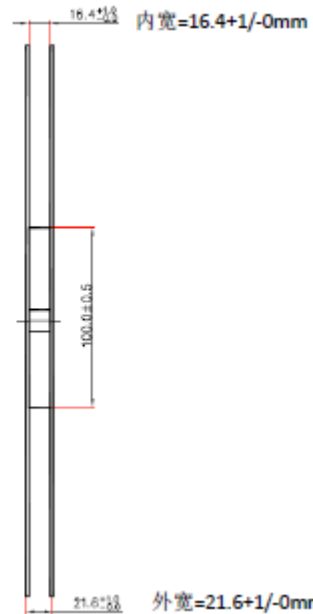
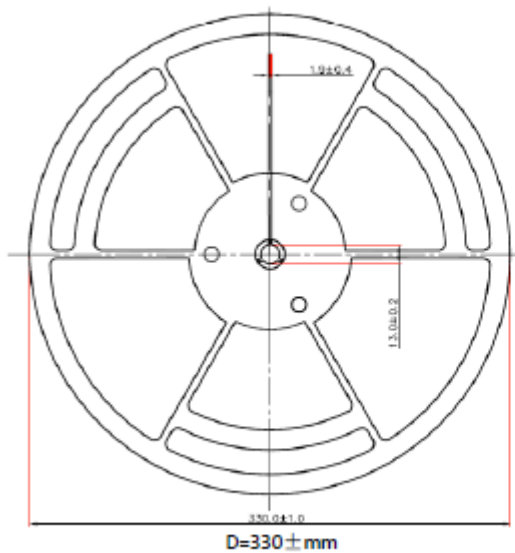

Note: page numbers for previous revisions may differ from page numbers in current version

Page or Item	Subjects (major changes since previous revision)
Rev 1.0 datasheet, 2019-8-27	
Whole document	New company logo released
Page 1	Remove "Figure 1. " and "May 2019"
Rev 1.1 datasheet, 2019-10-21	
Page 1	Change "high side and low side driver" to "600V half bridge driver"
Page 1	Change "independent" to "dependent"