

Power TVS in DO-15

Features

- 600Watts peak pulse power (10/1000μs)
- Class passivated junction
- High accuracy, 5% tolerance
- Uni and Bidirectional unit
- Low clamping voltage
- Low Leakage current
- Very fast response time

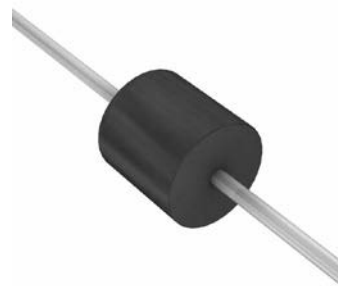

Mechanical Data

- **Case:** DO-15 (plastic package).
Lead free; RoHS compliant
- **Molding Compound Flammability Rating:**
UL 94 V-0
- **Terminals:** High temperature soldering guaranteed:
260 °C/10 sec. at terminals

Applications

- Computers
- Telecom systems
- Industrial equipments
- Consumer electronic applications
- Other VCC bus and I/O interfaces

Absolute Maximum Ratings

Ratings at 25 °C, ambient temperature unless otherwise specified

| Parameter | Symbols | Value | Unit |
|---|-----------------------------------|----------------|------|
| Peak power dissipation with a 10/1000us waveform ⁽¹⁾ (Fig. 1) | P _{PPM} | 600 | W |
| Peak pulse current with a 10/1000us waveform ⁽¹⁾ | I _{PPM} | See Next Table | A |
| Steady state power dissipation at T _L =75°C, lead lengths 0.375" (9.5mm) ⁽²⁾ | P _{M(AV)} | 5.0 | W |
| Peak forward surge current 8.3ms single half sine-wave ⁽³⁾ | I _{FSM} | 100 | A |
| Maximum instantaneous forward voltage @ 50A for unidirectional only ⁽⁴⁾ | V _F | 3.5/5.0 | V |
| Typical thermal resistance junction-to-lead | R _{θJL} | 20 | °C/W |
| Typical thermal resistance junction-to-ambient | R _{θJA} | 75 | °C/W |
| Operating junction and storage temperature range | T _J , T _{STG} | -55 to +150 | °C |

Notes:1.Non-repetitive current pulse, per Fig.3 and derated above T_A=25°C per Fig. 2

2. Mounted on copper pad area of 1.6 x 1.6" (40 x 40mm) per Fig. 5

3. Meas ed on 8.3ms single half sine-wave or equivalent square wave, duty cycle = 4 pulses per minute maximum

4. V_F=3.5 V for devices of V_(BR) < 220V, and V_F=5.0 Volt max. for devices of V_(BR)>220V

Electrical Characteristics

(T_A=25°C, Unless otherwise specified.)

| Part Number | Direction | Breakdown voltage V _(BR) (Volts) ⁽¹⁾ | | Test current at I _T (mA) | Stand-off voltage V _{WM} (Volts) | Maximum reverse leakage at V _{WM} I _D ⁽³⁾ (uA) | Maximum peak pulse current I _{PPM} ⁽²⁾ (A) | Maximum clamping voltage at I _{PPM} V _C (Volts) | Maximum temperature coefficient of V _{BR} (% /°C) |
|-------------|-----------|---|------|--|--|--|---|--|---|
| | | Min. | Max. | | | | | | |
| P6KE6.8A | Uni-Dir | 6.45 | 7.14 | 10 | 5.80 | 1000 | 57.1 | 10.5 | 0.057 |
| P6KE6.8CA | Bi-Dir | 6.45 | 7.14 | 10 | 5.80 | 1000 | 57.1 | 10.5 | 0.057 |
| P6KE7.5A | Uni-Dir | 7.13 | 7.88 | 10 | 6.40 | 500 | 53.1 | 11.3 | 0.061 |
| P6KE7.5CA | Bi-Dir | 7.13 | 7.88 | 10 | 6.40 | 500 | 53.1 | 11.3 | 0.061 |
| P6KE8.2A | Uni-Dir | 7.79 | 8.61 | 10 | 7.02 | 200 | 49.6 | 12.1 | 0.065 |
| P6KE8.2CA | Bi-Dir | 7.79 | 8.61 | 10 | 7.02 | 200 | 49.6 | 12.1 | 0.065 |
| P6KE9.1A | Uni-Dir | 8.65 | 9.55 | 1.0 | 7.78 | 50 | 44.8 | 13.4 | 0.068 |
| P6KE9.1CA | Bi-Dir | 8.65 | 9.55 | 1.0 | 7.78 | 50 | 44.8 | 13.4 | 0.068 |
| P6KE10A | Uni-Dir | 9.50 | 10.5 | 1.0 | 8.55 | 10 | 41.4 | 14.5 | 0.073 |
| P6KE10CA | Bi-Dir | 9.50 | 10.5 | 1.0 | 8.55 | 10 | 41.4 | 14.5 | 0.073 |
| P6KE11A | Uni-Dir | 10.5 | 11.6 | 1.0 | 9.40 | 5.0 | 38.5 | 15.6 | 0.075 |
| P6KE11CA | Bi-Dir | 10.5 | 11.6 | 1.0 | 9.40 | 5.0 | 38.5 | 15.6 | 0.075 |
| P6KE12A | Uni-Dir | 11.4 | 12.6 | 1.0 | 10.2 | 5.0 | 35.9 | 16.7 | 0.078 |
| P6KE12CA | Bi-Dir | 11.4 | 12.6 | 1.0 | 10.2 | 5.0 | 35.9 | 16.7 | 0.078 |
| P6KE13A | Uni-Dir | 12.4 | 13.7 | 1.0 | 11.1 | 5.0 | 33.0 | 18.2 | 0.081 |
| P6KE13CA | Bi-Dir | 12.4 | 13.7 | 1.0 | 11.1 | 5.0 | 33.0 | 18.2 | 0.081 |
| P6KE15A | Uni-Dir | 14.3 | 15.8 | 1.0 | 12.8 | 1.0 | 28.3 | 21.2 | 0.084 |
| P6KE15CA | Bi-Dir | 14.3 | 15.8 | 1.0 | 12.8 | 1.0 | 28.3 | 21.2 | 0.084 |
| P6KE16A | Uni-Dir | 15.2 | 16.8 | 1.0 | 13.6 | 1.0 | 26.7 | 22.5 | 0.086 |
| P6KE16CA | Bi-Dir | 15.2 | 16.8 | 1.0 | 13.6 | 1.0 | 26.7 | 22.5 | 0.086 |
| P6KE18A | Uni-Dir | 17.1 | 18.9 | 1.0 | 15.3 | 1.0 | 23.8 | 25.2 | 0.088 |
| P6KE18CA | Bi-Dir | 17.1 | 18.9 | 1.0 | 15.3 | 1.0 | 23.8 | 25.2 | 0.088 |
| P6KE20A | Uni-Dir | 19.0 | 21.0 | 1.0 | 17.1 | 1.0 | 21.7 | 27.7 | 0.090 |
| P6KE20CA | Bi-Dir | 19.0 | 21.0 | 1.0 | 17.1 | 1.0 | 21.7 | 27.7 | 0.090 |
| P6KE22A | Uni-Dir | 20.9 | 23.1 | 1.0 | 18.8 | 1.0 | 19.6 | 30.6 | 0.092 |
| P6KE22CA | Bi-Dir | 20.9 | 23.1 | 1.0 | 18.8 | 1.0 | 19.6 | 30.6 | 0.092 |
| P6KE24A | Uni-Dir | 22.8 | 25.2 | 1.0 | 20.5 | 1.0 | 18.1 | 33.2 | 0.094 |
| P6KE24CA | Bi-Dir | 22.8 | 25.2 | 1.0 | 20.5 | 1.0 | 18.1 | 33.2 | 0.094 |
| P6KE27A | Uni-Dir | 25.7 | 28.4 | 1.0 | 23.1 | 1.0 | 16.0 | 37.5 | 0.096 |
| P6KE27CA | Bi-Dir | 25.7 | 28.4 | 1.0 | 23.1 | 1.0 | 16.0 | 37.5 | 0.096 |
| P6KE30A | Uni-Dir | 28.5 | 31.5 | 1.0 | 25.6 | 1.0 | 14.5 | 41.4 | 0.097 |
| P6KE30CA | Bi-Dir | 28.5 | 31.5 | 1.0 | 25.6 | 1.0 | 14.5 | 41.4 | 0.097 |
| P6KE33A | Uni-Dir | 31.4 | 34.7 | 1.0 | 28.2 | 1.0 | 13.1 | 45.7 | 0.098 |
| P6KE33CA | Bi-Dir | 31.4 | 34.7 | 1.0 | 28.2 | 1.0 | 13.1 | 45.7 | 0.098 |
| P6KE36A | Uni-Dir | 34.2 | 37.8 | 1.0 | 30.8 | 1.0 | 12.0 | 49.9 | 0.099 |
| P6KE36CA | Bi-Dir | 34.2 | 37.8 | 1.0 | 30.8 | 1.0 | 12.0 | 49.9 | 0.099 |
| P6KE39A | Uni-Dir | 37.1 | 41.0 | 1.0 | 33.3 | 1.0 | 11.1 | 53.9 | 0.100 |
| P6KE39CA | Bi-Dir | 37.1 | 41.0 | 1.0 | 33.3 | 1.0 | 11.1 | 53.9 | 0.100 |
| P6KE43A | Uni-Dir | 40.9 | 45.2 | 1.0 | 36.8 | 1.0 | 10.1 | 59.3 | 0.101 |
| P6KE43CA | Bi-Dir | 40.9 | 45.2 | 1.0 | 36.8 | 1.0 | 10.1 | 59.3 | 0.101 |
| P6KE47A | Uni-Dir | 44.7 | 49.4 | 1.0 | 40.2 | 1.0 | 9.3 | 64.8 | 0.101 |

| Part Number | Direction | Breakdown voltage V_{BR} (Volts) ⁽¹⁾ | | Test current at I_T (mA) | Stand-off voltage V_{WM} (Volts) | Maximum reverse leakage at V_{WM} $I_D^{(3)}$ (uA) | Maximum peak pulse current $I_{PPM}^{(2)}$ (A) | Maximum clamping voltage at I_{PPM} V_C (Volts) | Maximum temperature coefficient of V_{BR} (%/°C) |
|-------------|-----------|---|------|----------------------------|------------------------------------|--|--|---|--|
| | | Min. | Max. | | | | | | |
| P6KE47CA | Bi-Dir | 44.7 | 49.4 | 1.0 | 40.2 | 1.0 | 9.3 | 64.8 | 0.101 |
| P6KE51A | Uni-Dir | 48.5 | 53.6 | 1.0 | 43.6 | 1.0 | 8.6 | 70.1 | 0.102 |
| P6KE51CA | Bi-Dir | 48.5 | 53.6 | 1.0 | 43.6 | 1.0 | 8.6 | 70.1 | 0.102 |
| P6KE56A | Uni-Dir | 53.2 | 58.8 | 1.0 | 47.8 | 1.0 | 7.8 | 77.0 | 0.103 |
| P6KE56CA | Bi-Dir | 53.2 | 58.8 | 1.0 | 47.8 | 1.0 | 7.8 | 77.0 | 0.103 |
| P6KE62A | Uni-Dir | 58.9 | 65.1 | 1.0 | 53.0 | 1.0 | 7.1 | 85.0 | 0.104 |
| P6KE62CA | Bi-Dir | 58.9 | 65.1 | 1.0 | 53.0 | 1.0 | 7.1 | 85.0 | 0.104 |
| P6KE68A | Uni-Dir | 64.6 | 71.4 | 1.0 | 58.1 | 1.0 | 6.5 | 92.0 | 0.104 |
| P6KE68CA | Bi-Dir | 64.6 | 71.4 | 1.0 | 58.1 | 1.0 | 6.5 | 92.0 | 0.104 |
| P6KE75A | Uni-Dir | 71.3 | 78.8 | 1.0 | 64.1 | 1.0 | 5.8 | 103 | 0.105 |
| P6KE75CA | Bi-Dir | 71.3 | 78.8 | 1.0 | 64.1 | 1.0 | 5.8 | 103 | 0.105 |
| P6KE82A | Uni-Dir | 77.9 | 86.1 | 1.0 | 70.1 | 1.0 | 5.3 | 113 | 0.105 |
| P6KE82CA | Bi-Dir | 77.9 | 86.1 | 1.0 | 70.1 | 1.0 | 5.3 | 113 | 0.105 |
| P6KE91A | Uni-Dir | 86.5 | 95.5 | 1.0 | 77.8 | 1.0 | 4.8 | 125 | 0.106 |
| P6KE91CA | Bi-Dir | 86.5 | 95.5 | 1.0 | 77.8 | 1.0 | 4.8 | 125 | 0.106 |
| P6KE100A | Uni-Dir | 95.0 | 105 | 1.0 | 85.5 | 1.0 | 4.4 | 137 | 0.106 |
| P6KE100CA | Bi-Dir | 95.0 | 105 | 1.0 | 85.5 | 1.0 | 4.4 | 137 | 0.106 |
| P6KE110A | Uni-Dir | 105 | 116 | 1.0 | 94.0 | 1.0 | 3.9 | 152 | 0.107 |
| P6KE110CA | Bi-Dir | 105 | 116 | 1.0 | 94.0 | 1.0 | 3.9 | 152 | 0.107 |
| P6KE120A | Uni-Dir | 114 | 126 | 1.0 | 102 | 1.0 | 3.6 | 165 | 0.107 |
| P6KE120CA | Bi-Dir | 114 | 126 | 1.0 | 102 | 1.0 | 3.6 | 165 | 0.107 |
| P6KE130A | Uni-Dir | 124 | 137 | 1.0 | 111 | 1.0 | 3.4 | 179 | 0.107 |
| P6KE130CA | Bi-Dir | 124 | 137 | 1.0 | 111 | 1.0 | 3.4 | 179 | 0.107 |
| P6KE150A | Uni-Dir | 143 | 158 | 1.0 | 128 | 1.0 | 2.9 | 207 | 0.108 |
| P6KE150CA | Bi-Dir | 143 | 158 | 1.0 | 128 | 1.0 | 2.9 | 207 | 0.108 |
| P6KE160A | Uni-Dir | 152 | 168 | 1.0 | 136 | 1.0 | 2.7 | 219 | 0.108 |
| P6KE160CA | Bi-Dir | 152 | 168 | 1.0 | 136 | 1.0 | 2.7 | 219 | 0.108 |
| P6KE170A | Uni-Dir | 162 | 179 | 1.0 | 145 | 1.0 | 2.6 | 234 | 0.108 |
| P6KE170CA | Bi-Dir | 162 | 179 | 1.0 | 145 | 1.0 | 2.6 | 234 | 0.108 |
| P6KE180A | Uni-Dir | 171 | 189 | 1.0 | 154 | 1.0 | 2.4 | 246 | 0.108 |
| P6KE180CA | Bi-Dir | 171 | 189 | 1.0 | 154 | 1.0 | 2.4 | 246 | 0.108 |
| P6KE200A | Uni-Dir | 190 | 210 | 1.0 | 171 | 1.0 | 2.2 | 274 | 0.108 |
| P6KE200CA | Bi-Dir | 190 | 210 | 1.0 | 171 | 1.0 | 2.2 | 274 | 0.108 |
| P6KE220A | Uni-Dir | 209 | 231 | 1.0 | 185 | 1.0 | 1.8 | 328 | 0.108 |
| P6KE220CA | Bi-Dir | 209 | 231 | 1.0 | 185 | 1.0 | 1.8 | 328 | 0.108 |
| P6KE250A | Uni-Dir | 237 | 263 | 1.0 | 214 | 1.0 | 1.7 | 344 | 0.110 |
| P6KE250CA | Bi-Dir | 237 | 263 | 1.0 | 214 | 1.0 | 1.7 | 344 | 0.110 |
| P6KE300A | Uni-Dir | 285 | 315 | 1.0 | 256 | 1.0 | 1.4 | 414 | 0.110 |
| P6KE300CA | Bi-Dir | 285 | 315 | 1.0 | 256 | 1.0 | 1.4 | 414 | 0.110 |
| P6KE350A | Uni-Dir | 333 | 368 | 1.0 | 300 | 1.0 | 1.2 | 482 | 0.110 |
| P6KE350CA | Bi-Dir | 333 | 368 | 1.0 | 300 | 1.0 | 1.2 | 482 | 0.110 |
| P6KE400A | Uni-Dir | 380 | 420 | 1.0 | 342 | 1.0 | 1.1 | 548 | 0.110 |
| P6KE400CA | Bi-Dir | 380 | 420 | 1.0 | 342 | 1.0 | 1.1 | 548 | 0.110 |
| P6KE440A | Uni-Dir | 418 | 462 | 1.0 | 376 | 1.0 | 1.0 | 602 | 0.110 |
| P6KE440CA | Bi-Dir | 418 | 462 | 1.0 | 376 | 1.0 | 1.0 | 602 | 0.110 |

| Part Number | Direction | Breakdown voltage $V_{(BR)}$ (Volts) ⁽¹⁾ | | Test current at I_T (mA) | Stand-off voltage V_{WM} (Volts) | Maximum reverse leakage at V_{WM} $I_D^{(3)}$ (uA) | Maximum peak pulse current $I_{PPM}^{(2)}$ (A) | Maximum clamping voltage at I_{PPM} V_C (Volts) | Maximum temperature coefficient of V_{BR} (%/°C) |
|-------------|-----------|---|-------|----------------------------|------------------------------------|--|--|---|--|
| | | Min. | Max. | | | | | | |
| P6KE480A | Uni-Dir | 456 | 504 | 1.0 | 408 | 1.0 | 0.9 | 658 | 0.110 |
| P6KE480CA | Bi-Dir | 456 | 504 | 1.0 | 408 | 1.0 | 0.9 | 658 | 0.110 |
| P6KE510A | Uni-Dir | 485 | 535 | 1.0 | 434 | 1.0 | 0.9 | 698 | 0.110 |
| P6KE510CA | Bi-Dir | 485 | 535 | 1.0 | 434 | 1.0 | 0.9 | 698 | 0.110 |
| P6KE530A | Uni-Dir | 503.5 | 556.5 | 1.0 | 450 | 1.0 | 0.8 | 725 | 0.110 |
| P6KE530CA | Bi-Dir | 503.5 | 556.5 | 1.0 | 450 | 1.0 | 0.8 | 725 | 0.110 |
| P6KE540A | Uni-Dir | 513 | 567 | 1.0 | 459 | 1.0 | 0.8 | 740 | 0.110 |
| P6KE540CA | Bi-Dir | 513 | 567 | 1.0 | 459 | 1.0 | 0.8 | 740 | 0.110 |
| P6KE550A | Uni-Dir | 522.5 | 577.5 | 1.0 | 467 | 1.0 | 0.8 | 760 | 0.110 |
| P6KE550CA | Bi-Dir | 522.5 | 577.5 | 1.0 | 467 | 1.0 | 0.8 | 760 | 0.110 |

- Notes: 1. $V_{(BR)}$ measured after I_T applied for 300us, I_T =square wave pulse or equivalent
 2. Surge current waveform per Fig. 3 and derate per Fig. 2
 3. For bidirectional types with V_{WM} of 10 volts and less, the I_D limit is doubled
 4. All terms and symbols are consistent with ANSI/IEEE C62.35
 5. For parts without A, the V_{BR} is $\pm 10\%$

Typical Characteristics ($T_{amb} = 25^\circ\text{C}$ unless otherwise specified)

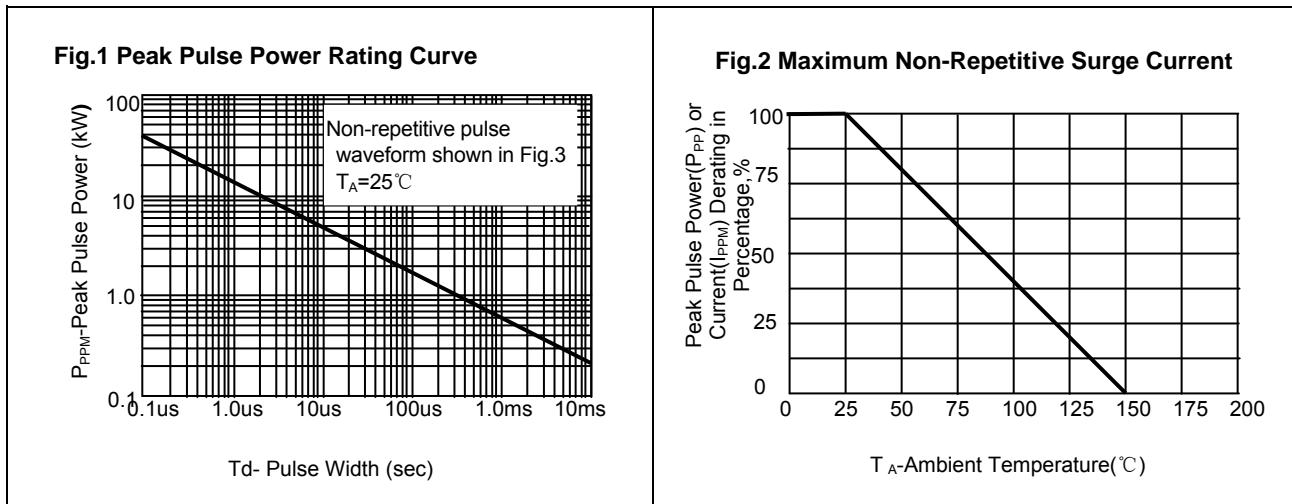

Fig.3 Typical Forward Characteristics

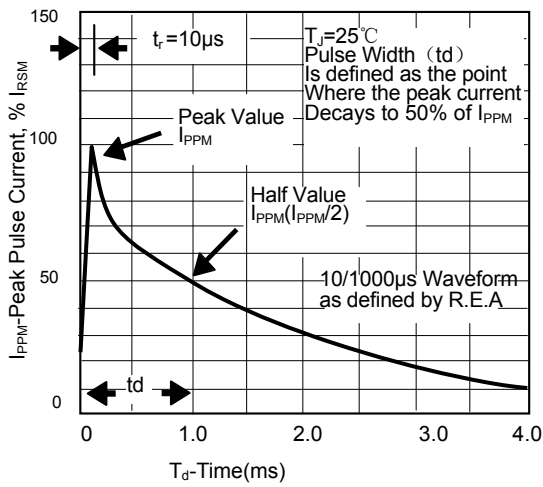

Fig.4 Typ. Junction Capacitance Uni-Directional



Fig.5 Steady State Power Derating Curve

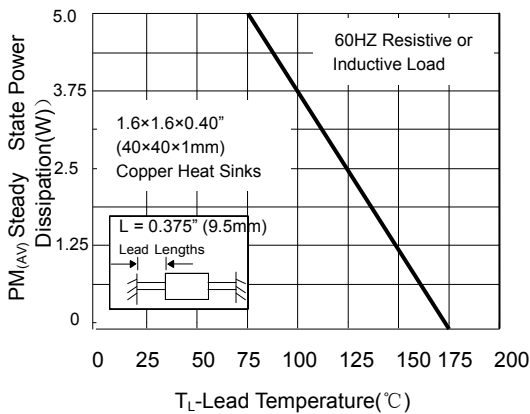

Fig.6 Max. Non-Repetitive Forward Surge Curren Uni-Directional Only

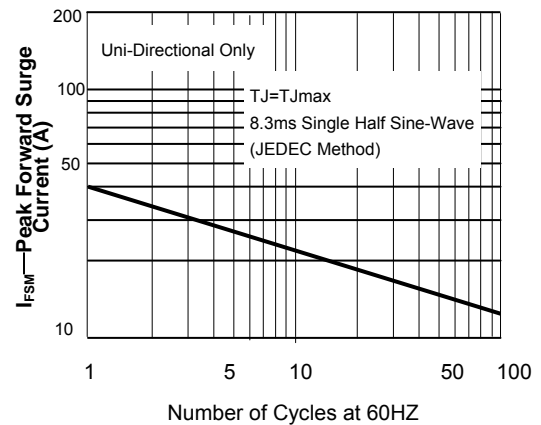
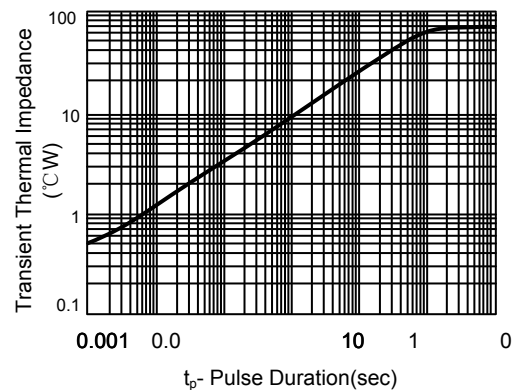

Fig.7 Typical Reverse Leakage Characteristics



Fig.8 Typ. Transient Thermal Impedance



Package Dimensions

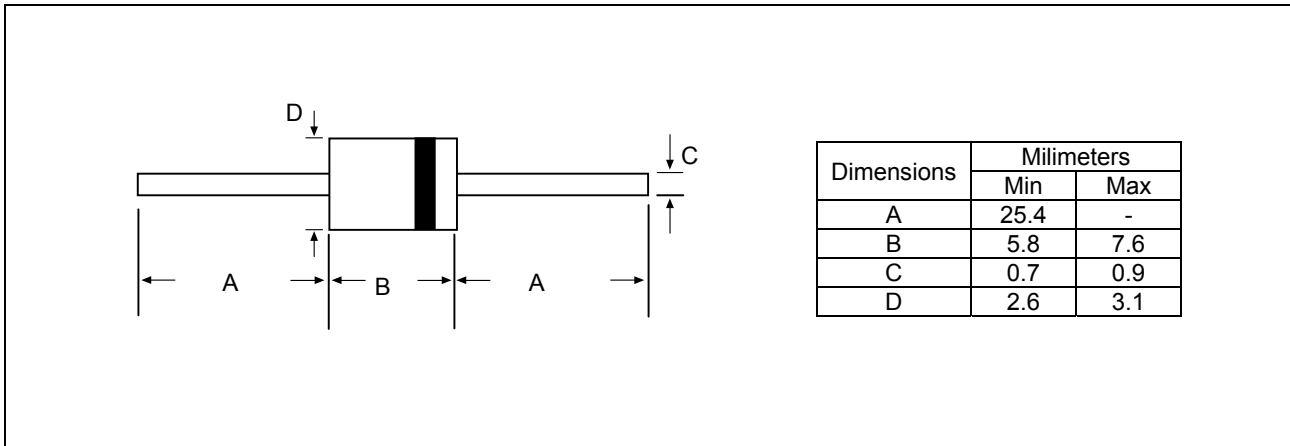

Part number system

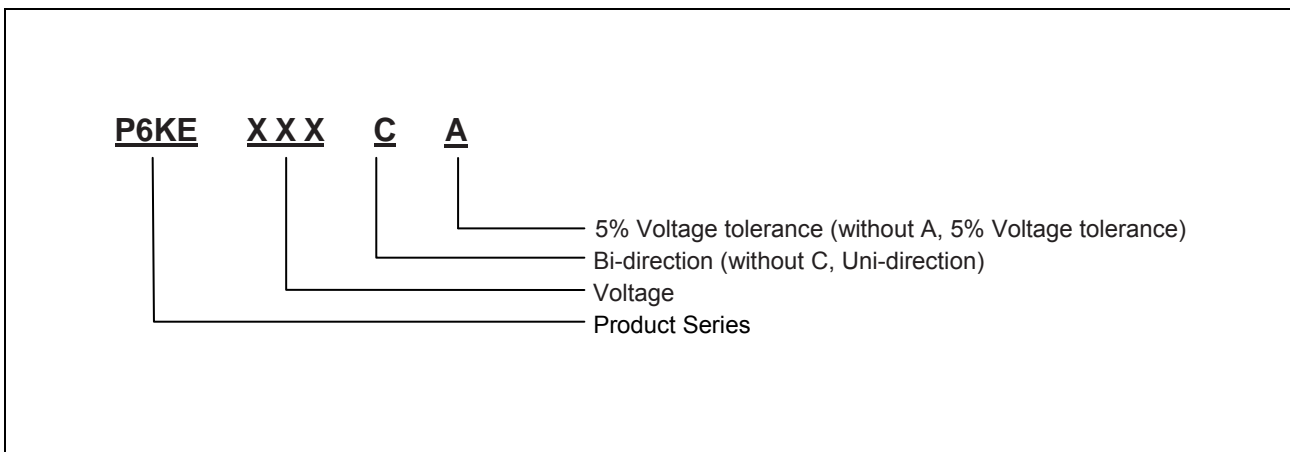

Ordering information

| Order code | Package | Packaging option | Base quantity | Packaging specification |
|-------------|---------|------------------|---------------|-------------------------|
| P6KExxA(CA) | DO-15 | Tape and BOX | 3000pcs | EIA STD RS-481 |

Reision history

| Date | Revision | Changes |
|-------------|----------|-----------------|
| 23-May-2012 | 1.0 | Initial release |

CAUTION / WARNING

Information in this document is believed to be accurate and reliable. However, CREATEK does not give any representations or warranties, expressed or implied, as to the accuracy or completeness of such information and shall have no liability for the consequences of use of such information.

Users should independently evaluate the suitability of and test each product selected for their own applications, and CREATEK assumes no liability whatsoever relating to the choice, selection or use of the CREATEK products and services described herein.

CREATEK reserves the right to change or update, without notice, any information contained in this publication; to change, without notice, the design, construction, processing, or specification of any product; and to discontinue or limit production or distribution of any product.

Information in this document supersedes and replaces all information previously supplied.

Products are not designed, authorized or warranted to be suitable for use in medical, military, aircraft, space or life support equipment, nor in applications where failure or malfunction of an CREATEK product can reasonably be expected to result in personal injury, death or severe property or environmental damage. CREATEK accepts no liability for inclusion and/or use of CREATEK products in such equipment or applications and therefore such inclusion and/or use is at the customer's own risk.

This document as well as the item(s) described herein may be subject to export control regulations. Export might require a prior authorization from national authorities.

Resale of CREATEK products with provisions different from the statements and/or technical features set forth in this document shall immediately void any warranty granted by CREATEK for the CREATEK product or service described herein and shall not create or extend in any manner whatsoever, any liability of CREATEK.

CREATEK expressly disclaims all implied warranties regarding the information contained herein, including, but not limited to, any implied warranties of merchantability or fitness for a particular purpose. CREATEK only obligations are those in the CREATEK Standard Terms and Conditions of Sale and in no case will CREATEK be liable for any incidental, indirect, or consequential damages arising from the sale, resale, use, or misuse of its products.

Specifications are subject to change without notice

© Copyright 2009, CREATEK Microelectronics

 CREATEK® is a registered trademark of CREATEK Microelectronics

All rights reserved