



Single/Dual/Quad, +1.8V/750nA, SC70, Rail-to-Rail Op Amps

General Description

The MAX4464/MAX4470/MAX4471/MAX4472/MAX4474 family of micropower op amps operate from a single +1.8V to +5.5V supply and draw only 750nA of supply current. The MAX4470 family feature ground-sensing inputs and rail-to-rail output. The ultra-low supply current, low-operating voltage, and rail-to-rail output capabilities make these operational amplifiers ideal for use in single lithium ion (Li+), or two-cell NiCd or alkaline battery systems.

The rail-to-rail output stage of the MAX4464/MAX4470/MAX4471/MAX4472/MAX4474 amplifiers is capable of driving the output voltage to within 4mV of the rail with a 100kΩ load, and can sink and source 11mA with a +5V supply. These amplifiers are available in both fully compensated and decompensated versions. The single MAX4470, dual MAX4471, and the quad MAX4472 are unity-gain stable. The single MAX4464 and the dual MAX4474 are stable for closed-loop gain configurations of $\geq +5V/V$. These amplifiers are available in space-saving WLP, SC70, SOT23, μ MAX®, and TSSOP packages.

Applications

Battery-Powered Systems	Electrometer Amplifiers
Portable Instrumentation	Solar-Powered Systems
Pagers and Cellphones	Remote Sensor Active Badges
Micropower Thermostats	pH Meters

Pin Configurations

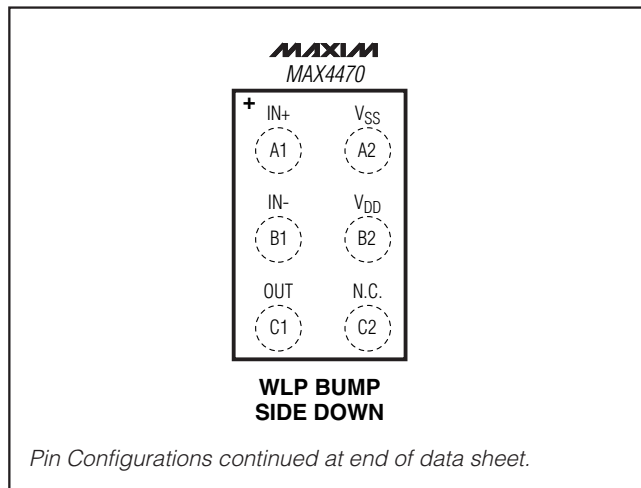

μ MAX is a registered trademark of Maxim Integrated Products, Inc.

Features

- ◆ Ultra-Low 750nA Supply Current Per Amplifier
- ◆ Ultra-Low +1.8V Supply Voltage Operation
- ◆ Ground-Sensing Input Common-Mode Range
- ◆ Outputs Swing Rail-to-Rail
- ◆ Outputs Source and Sink 11mA of Load Current
- ◆ No Phase Reversal for Overdriven Inputs
- ◆ High 120dB Open-Loop Voltage Gain
- ◆ Low 500 μ V Input Offset Voltage
- ◆ 9kHz Gain-Bandwidth Product (MAX4470/MAX4471/MAX4472)
- ◆ 40kHz Gain-Bandwidth Product (MAX4464/MAX4474)
- ◆ 250pF (min) Capacitive Load Capability
- ◆ Available in Tiny, 6-Bump WLP, 5-Pin SC70, and 8-Pin SOT23 Packages

Ordering Information

PART	TEMP RANGE	PIN-PACKAGE	TOP MARK
MAX4464EXK+T	-40°C to +85°C	5 SC70	+ABT
MAX4464EUK+T	-40°C to +85°C	5 SOT23	+ADPI
MAX4470EXK+T	-40°C to +85°C	5 SC70	+ABS
MAX4470EUK+T	-40°C to +85°C	5 SOT23	+ADPH
MAX4470EWT+	-40°C to +85°C	6 WLP	+BP
MAX4471EKA+T	-40°C to +85°C	8 SOT23	+AAEK
MAX4471ESA+	-40°C to +85°C	8 SO	—
MAX4472EUD+	-40°C to +85°C	14 TSSOP	—
MAX4472ESD+	-40°C to +85°C	14 SO	—
MAX4474EKA+T	-40°C to +85°C	8 SOT23	+AAEL
MAX4474EUA+	-40°C to +85°C	8 μ MAX	—
MAX4474ESA+	-40°C to +85°C	8 SO	—

+Denotes a lead(Pb)-free/RoHS-compliant package.

Selector Guide

PART	NO. OF AMPLIFIERS	GAIN-BANDWIDTH	MINIMUM STABLE GAIN
MAX4464	1	40kHz	5V/V
MAX4470	1	9kHz	1V/V
MAX4471	2	9kHz	1V/V
MAX4472	4	9kHz	1V/V
MAX4474	2	40kHz	5V/V

MAX4464/MAX4470/MAX4471/MAX4472/MAX4474



Single/Dual/Quad, +1.8V/750nA, SC70, Rail-to-Rail Op Amps

ABSOLUTE MAXIMUM RATINGS

V _{DD} to V _{SS}	-0.3V to +6V	8-Pin SO (derate 5.88mW/°C above +70°C).....	471mW
IN ₊ or IN ₋	(V _{SS} - 0.3V) to (V _{DD} + 0.3V)	14-Pin TSSOP (derate 9.1mW/°C above +70°C)	727mW
OUT ₋ Shorted to V _{SS} or V _{DD}	Continuous	14-Pin SO (derate 8.33mW/°C above +70°C).....	667mW
Continuous Power Dissipation (T _A = +70°C)		Operating Temperature Range	-40°C to +85°C
5-Pin SC70 (derate 3.1mW/°C above +70°C).....	.247mW	Junction Temperature	+150°C
5-Pin SOT23 (derate 7.1mW/°C above +70°C).....	.571mW	Storage Temperature Range	-65°C to +150°C
6-Bump WLP (derate 10.5mW/°C above +70°C)840mW	Lead Temperature (soldering, 10s)	+300°C
8-Pin SOT23 (derate 8.9mW/°C above +70°C).....	.714mW	Soldering Temperature (reflow)	+260°C
8-Pin μMAX (derate 4.5mW/°C above +70°C).....	.362mW		

Stresses beyond those listed under "Absolute Maximum Ratings" may cause permanent damage to the device. These are stress ratings only, and functional operation of the device at these or any other conditions beyond those indicated in the operational sections of the specifications is not implied. Exposure to absolute maximum rating conditions for extended periods may affect device reliability.

ELECTRICAL CHARACTERISTICS

(V_{DD} = +5V, V_{SS} = 0V, V_{CM} = 0V, V_{OUT} = V_{DD}/2, R_L = ∞ to V_{DD}/2, T_A = +25°C, unless otherwise noted.)

PARAMETER	SYMBOL	CONDITIONS	MIN	TYP	MAX	UNITS	
Supply Voltage Range	V _{DD}	Guaranteed by PSRR tests	1.8		5.5	V	
Supply Current (Per Amplifier)	I _{DD}	V _{DD} = +1.8V		0.6		μA	
		V _{DD} = +5.0V		0.75	1.2		
Input Offset Voltage	V _{OS}			±0.5	±7.0	mV	
Input Bias Current	I _B			±200	±1500	pA	
Input Offset Current	I _{OS}			±12.5		pA	
Input Common-Mode Voltage Range	V _{CM}	Guaranteed by the CMRR test	V _{SS}		V _{DD} -1.1	V	
Common-Mode Rejection Ratio	CMRR	Specified with V _{SS} ≤ V _{CM} ≤ (V _{DD} - 1.1V)	70	95		dB	
Power-Supply Rejection Ratio	PSRR	+1.8V ≤ V _{DD} ≤ +5.5V	70	90		dB	
Large-Signal Voltage Gain	A _{VOL}	R _L = 1MΩ, V _{OUT} = 50mV to V _{DD} - 50mV	90	120		dB	
		R _L = 100kΩ, V _{OUT} = 200mV to V _{DD} - 200mV	90	112			
		R _L = 10kΩ, V _{OUT} = 200mV to V _{DD} - 200mV		100			
Output Voltage Swing	V _{OH}	Swing high specified as V _{DD} - V _{OH}	R _L = 1MΩ		1	4	mV
			R _L = 100kΩ		4	10	
			R _L = 10kΩ		40		
	V _{VOL}	Swing low specified as V _{VOL} - V _{SS}	R _L = 1MΩ		0.5	5	
			R _L = 100kΩ		1	5	
			R _L = 10kΩ		10		
Gain-Bandwidth Product	GBW	MAX4470/MAX4471/MAX4472		9		kHz	
		MAX4464/MAX4474		40			
Phase Margin	φ _M	MAX4470/MAX4471/MAX4472		90		degrees	
		MAX4464/MAX4474		80			

Single/Dual/Quad, +1.8V/750nA, SC70, Rail-to-Rail Op Amps

MAX4464/MAX4470/MAX4471/MAX4472/MAX4474

ELECTRICAL CHARACTERISTICS (continued)

($V_{DD} = +5V$, $V_{SS} = 0V$, $V_{CM} = 0V$, $V_{OUT} = V_{DD}/2$, $R_L = \infty$ to $V_{DD}/2$, $T_A = +25^\circ C$, unless otherwise noted.)

PARAMETER	SYMBOL	CONDITIONS		MIN	TYP	MAX	UNITS
Slew Rate	SR	$V_{OUT} = 4V$ step	MAX4470/MAX4471/MAX4472		2		V/ms
			MAX4464/MAX4474		20		
Input Voltage Noise	e_n	f = 1kHz			150		nV/ \sqrt{Hz}
		f = 10kHz			120		
Output Short-Circuit Current		Shorted to V_{SS} (sourcing)			11		mA
		Shorted to V_{DD} (sinking)			36		
Power-On Time	t_{ON}				3		ms
Power-Off Time	t_{OFF}				2		μs
Capacitive Load	C_{LOAD}	No sustained oscillations		250			pF

ELECTRICAL CHARACTERISTICS

($V_{DD} = +5V$, $V_{SS} = 0V$, $V_{CM} = 0V$, $V_{OUT} = V_{DD}/2$, $R_L = \infty$ to $V_{DD}/2$, $T_A = T_{MIN}$ to T_{MAX} , unless otherwise noted.) (Note 1)

PARAMETER	SYMBOL	CONDITIONS		MIN	TYP	MAX	UNITS
Supply Voltage Range	V_{DD}	Guaranteed by PSRR tests		1.8		5.5	V
Supply Current (Per Amplifier)	I_{DD}	$V_{DD} = +5.0V$				1.5	μA
Input Offset Voltage	V_{OS}					± 15	mV
Input Offset Voltage Temperature Coefficient	TCV_{OS}				8		$\mu V/^\circ C$
Input Bias Current	I_B					4.25	nA
Input Common-Mode Voltage Range	V_{CM}	Guaranteed by the CMRR test		V_{SS}		$V_{DD} - 1.1$	V
Common-Mode Rejection Ratio	CMRR	$V_{SS} \leq V_{CM} \leq (V_{DD} - 1.1V)$		56			dB
Power-Supply Rejection Ratio	PSRR	$+1.8V \leq V_{DD} \leq +5.5V$, $0^\circ C \leq T_A \leq +85^\circ C$		65			dB
		$+2V \leq V_{DD} \leq +5.5V$, $-40^\circ C \leq T_A \leq +85^\circ C$		65			
Large-Signal Voltage Gain	A_{VOL}	$V_{OUT} = 50mV$ to $V_{DD} - 50mV$, $R_L = 1M\Omega$		75			dB
		$V_{OUT} = 200mV$ to $V_{DD} - 200mV$, $R_L = 100k\Omega$		75			
Output Voltage Swing	V_{OH}	Swing high specified as $V_{DD} - V_{OH}$	$R_L = 1M\Omega$			5	mV
			$R_L = 100k\Omega$			15	
	V_{OL}	Swing low specified as $V_{OL} - V_{SS}$	$R_L = 1M\Omega$			5	
			$R_L = 100k\Omega$			5	

Note 1: All devices are production tested at $T_A = +25^\circ C$. All temperature limits are guaranteed by design.

Single/Dual/Quad, +1.8V/750nA, SC70, Rail-to-Rail Op Amps

Typical Operating Characteristics

($V_{DD} = +5V$, $V_{SS} = 0V$, $V_{CM} = 0V$, $R_L = 100k\Omega$ to $V_{DD}/2$, $T_A = +25^\circ C$, unless otherwise noted.)

SUPPLY CURRENT PER AMPLIFIER vs. SUPPLY VOLTAGE

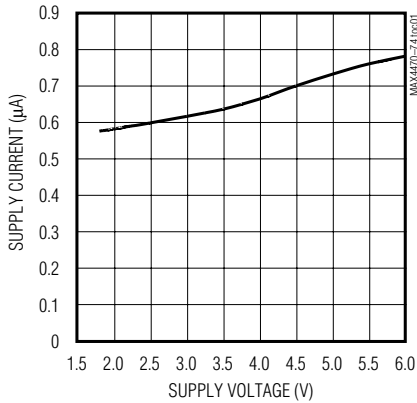

SUPPLY CURRENT PER AMPLIFIER vs. TEMPERATURE

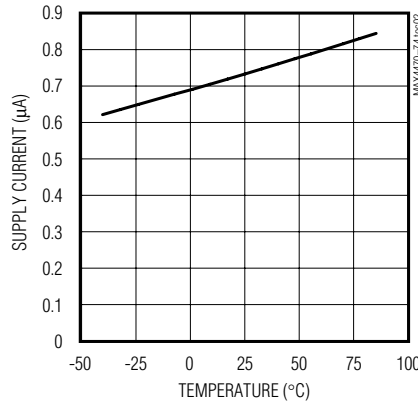

OFFSET VOLTAGE vs. TEMPERATURE

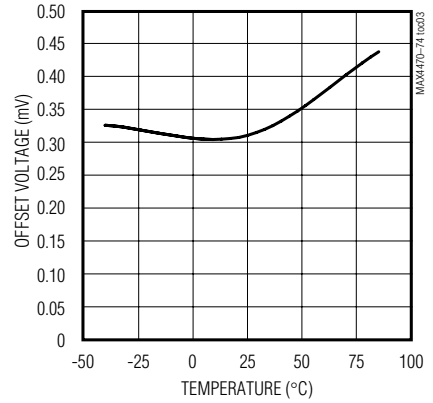

OFFSET VOLTAGE vs. COMMON-MODE VOLTAGE

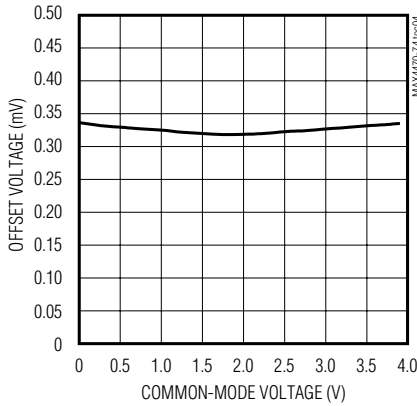

INPUT BIAS CURRENT vs. TEMPERATURE

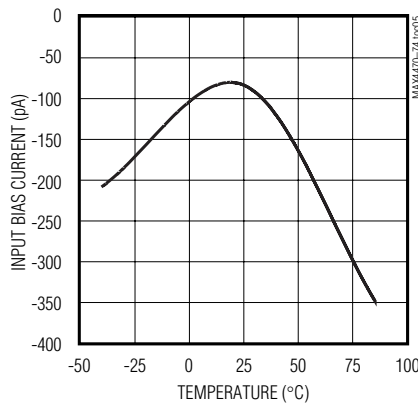

INPUT BIAS CURRENT vs. COMMON-MODE VOLTAGE

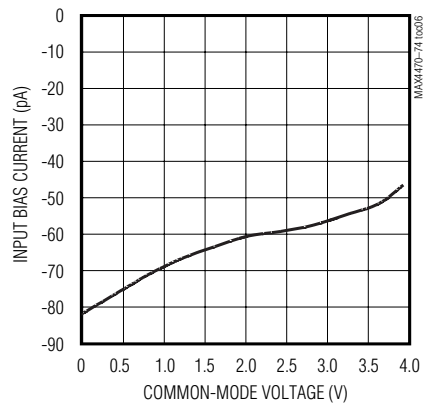

POWER-SUPPLY REJECTION RATIO vs. FREQUENCY

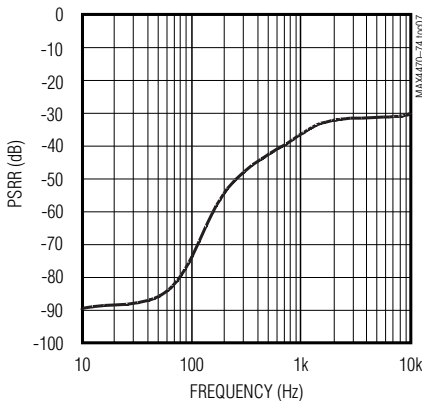

OUTPUT VOLTAGE SWING LOW vs. TEMPERATURE

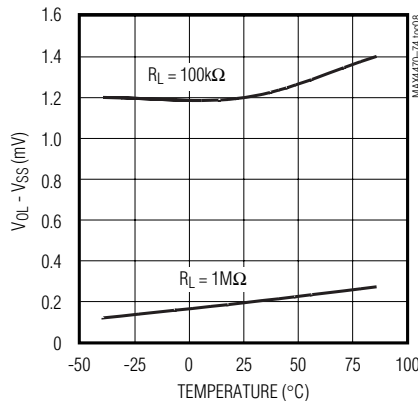

OUTPUT VOLTAGE SWING HIGH vs. TEMPERATURE

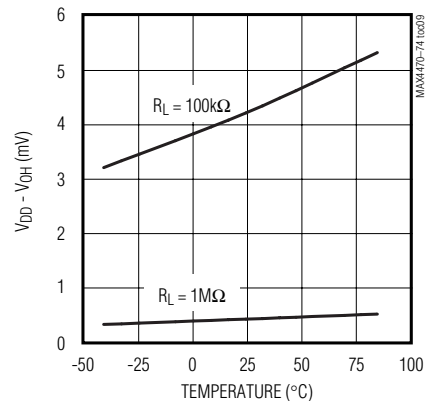

Single/Dual/Quad, +1.8V/750nA, SC70, Rail-to-Rail Op Amps

Typical Operating Characteristics (continued)

($V_{DD} = +5V$, $V_{SS} = 0V$, $V_{CM} = 0V$, $R_L = 100k\Omega$ to $V_{DD}/2$, $T_A = +25^\circ C$, unless otherwise noted.)

MAX4464/MAX4470/MAX4471/MAX4472/MAX4474

COMMON-MODE REJECTION RATIO vs. TEMPERATURE

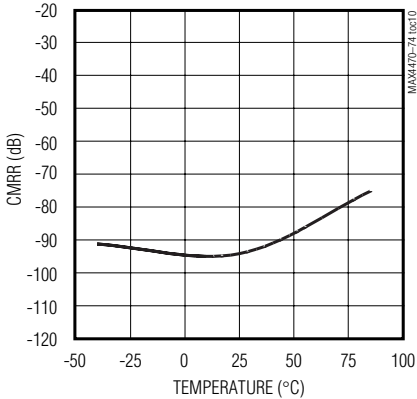

MINIMUM SUPPLY VOLTAGE vs. TEMPERATURE

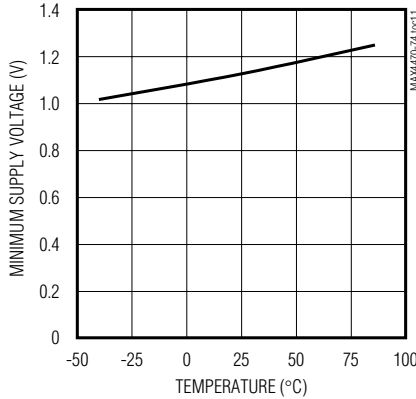

AVOL vs. OUTPUT VOLTAGE SWING

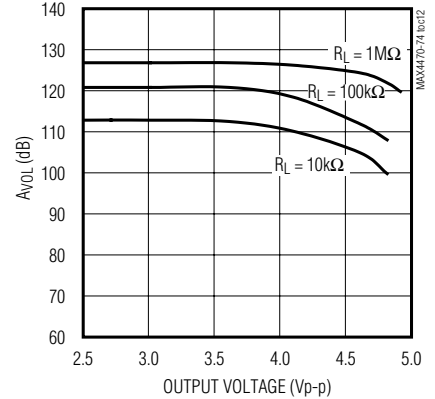

MAX4470/MAX4471/MAX4472 GAIN AND PHASE vs. FREQUENCY

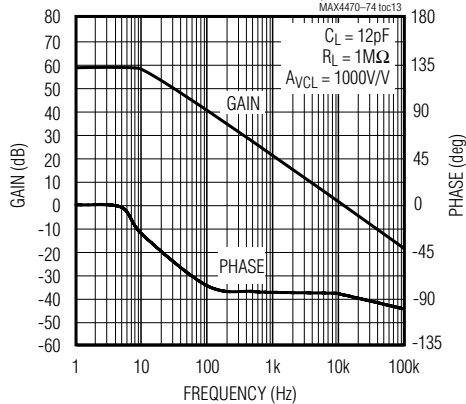

MAX4470/MAX4471/MAX4472 GAIN AND PHASE vs. FREQUENCY

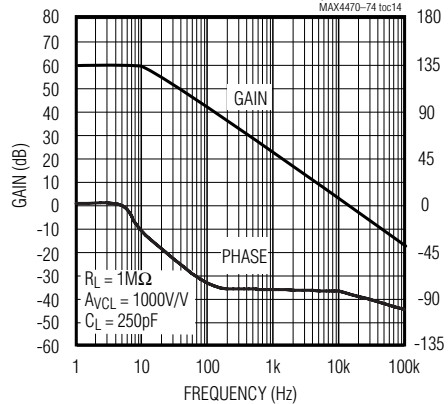

CROSSTALK vs. FREQUENCY

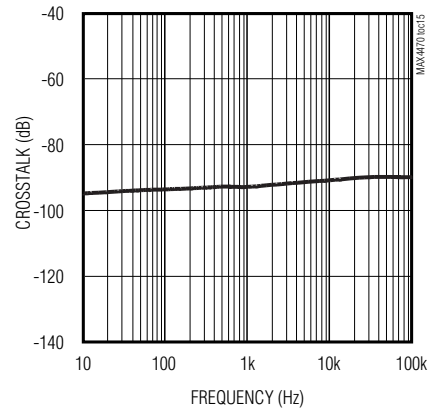

MAX4470/MAX4471/MAX4472 TOTAL HARMONIC DISTORTION PLUS NOISE vs. FREQUENCY

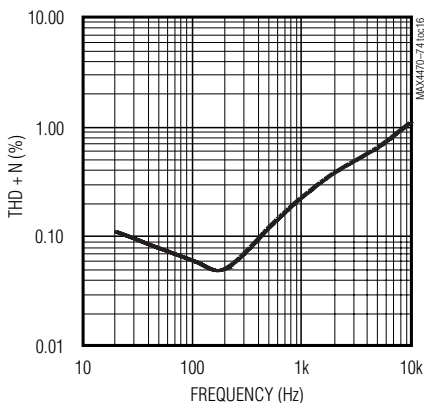

VOLTAGE NOISE DENSITY vs. FREQUENCY

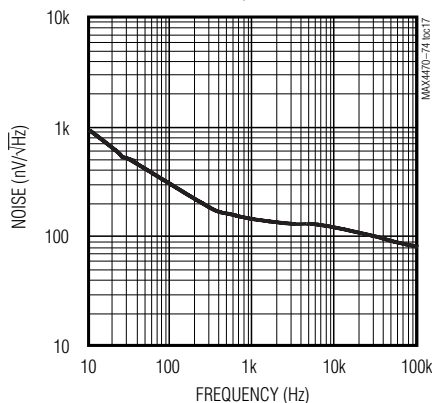

MAX4470/MAX4471/MAX4472 STABILITY vs. CAPACITIVE AND RESISTIVE LOADS

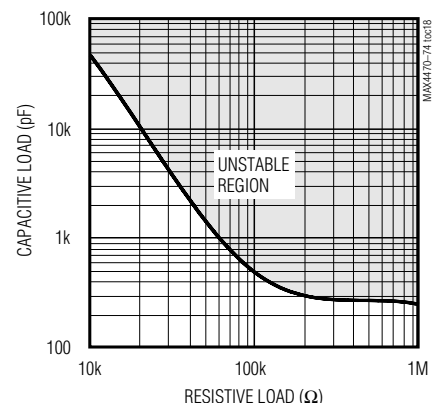

Single/Dual/Quad, +1.8V/750nA, SC70, Rail-to-Rail Op Amps

Typical Operating Characteristics (continued)

($V_{DD} = +5V$, $V_{SS} = 0V$, $V_{CM} = 0V$, $R_L = 100k\Omega$ to $V_{DD}/2$, $T_A = +25^\circ C$, unless otherwise noted.)

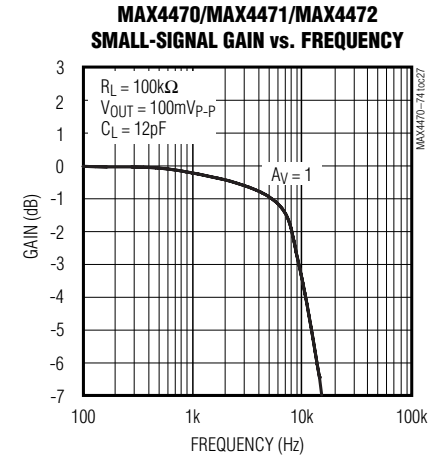
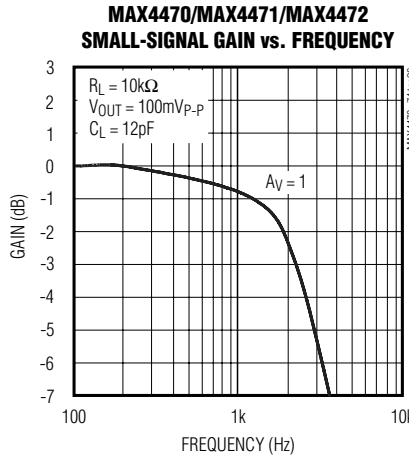
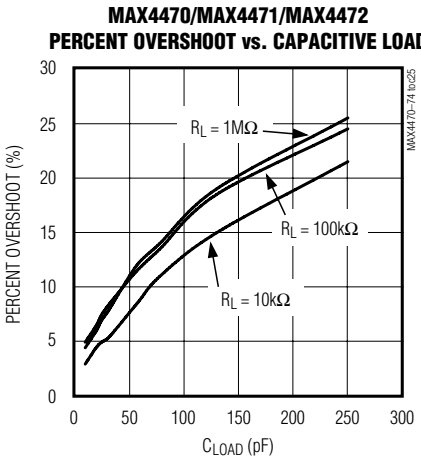
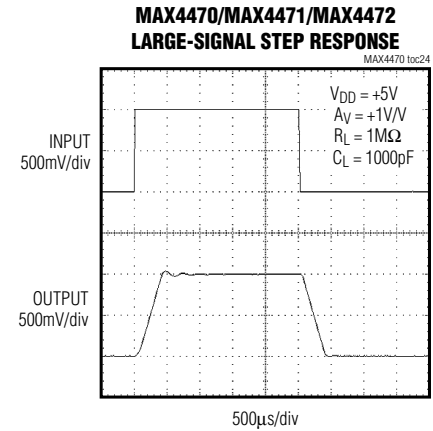
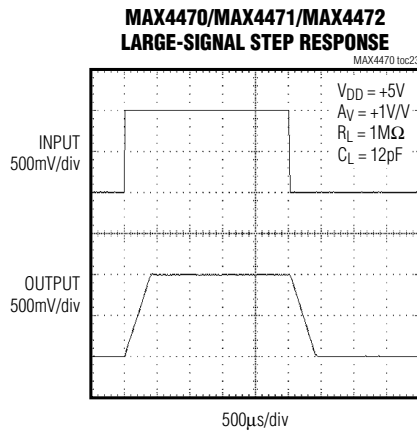
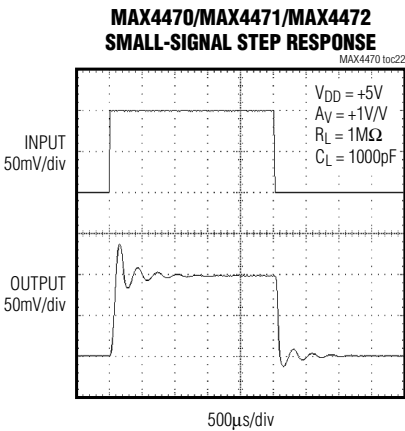
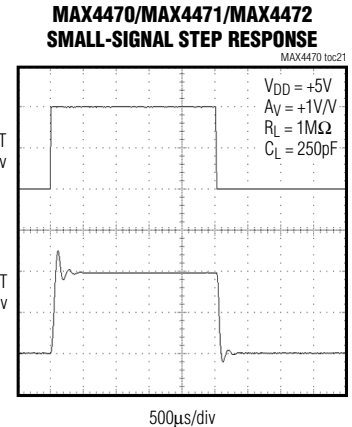
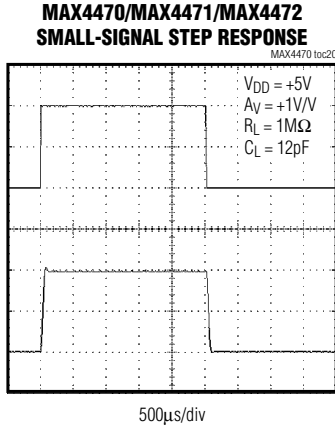
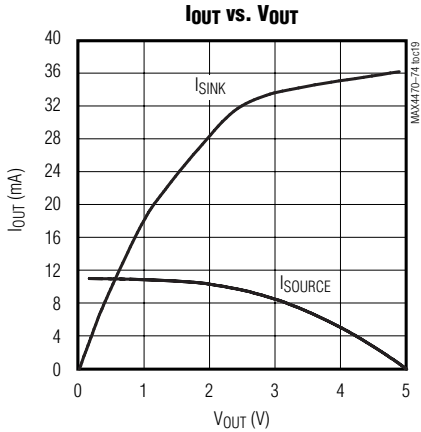

Single/Dual/Quad, +1.8V/750nA, SC70, Rail-to-Rail Op Amps

Typical Operating Characteristics (continued)

($V_{DD} = +5V$, $V_{SS} = 0V$, $V_{CM} = 0V$, $R_L = 100k\Omega$ to $V_{DD}/2$, $T_A = +25^\circ C$, unless otherwise noted.)

**MAX4470/MAX4471/MAX4472
SMALL-SIGNAL GAIN vs. FREQUENCY**

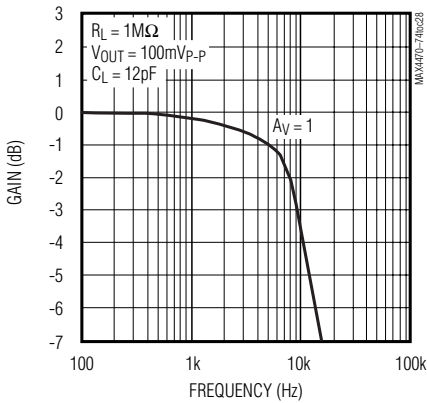

**MAX4470/MAX4471/MAX4472
LARGE-SIGNAL GAIN vs. FREQUENCY**

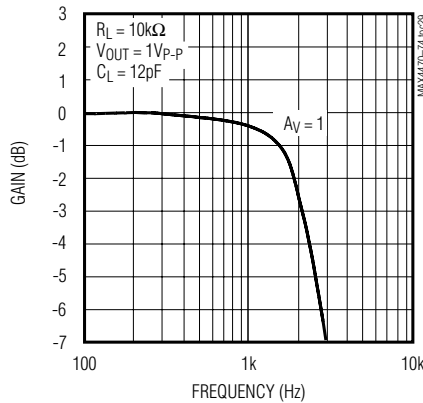

**MAX4470/MAX4471/MAX4472
LARGE-SIGNAL GAIN vs. FREQUENCY**

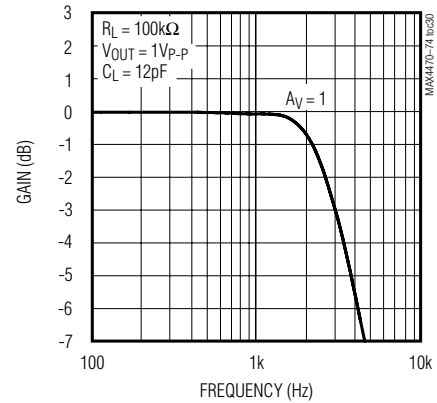

**MAX4470/MAX4471/MAX4472
LARGE-SIGNAL GAIN vs. FREQUENCY**

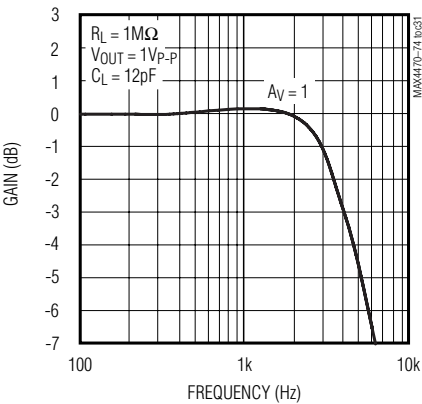

**MAX4464/MAX4474
GAIN AND PHASE vs. FREQUENCY**

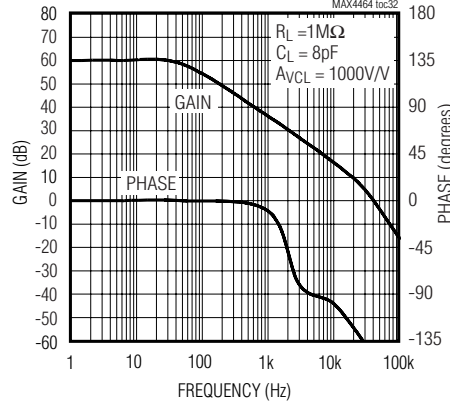

**MAX4464/MAX4474
GAIN AND PHASE vs. FREQUENCY**

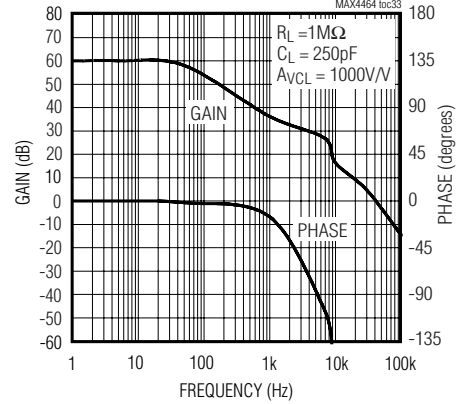

**MAX4464/MAX4474
TOTAL HARMONIC DISTORTION
PLUS NOISE vs. FREQUENCY**

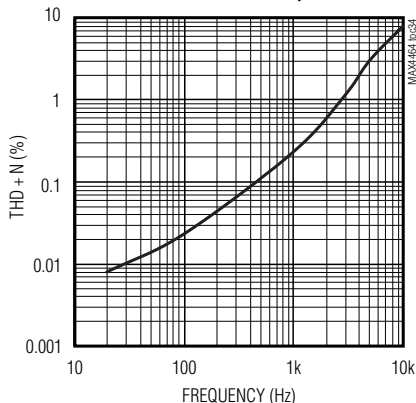

**MAX4464/MAX4474
STABILITY vs. CAPACITIVE
AND RESISTIVE LOADS**

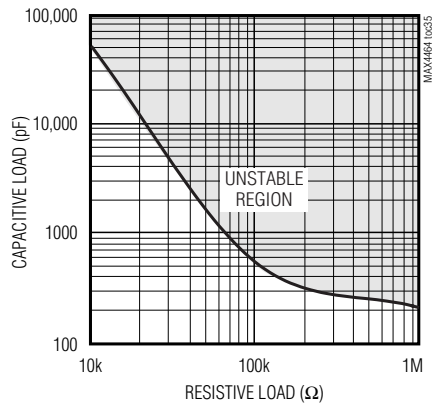

**MAX4464/MAX4474
SMALL-SIGNAL STEP RESPONSE**

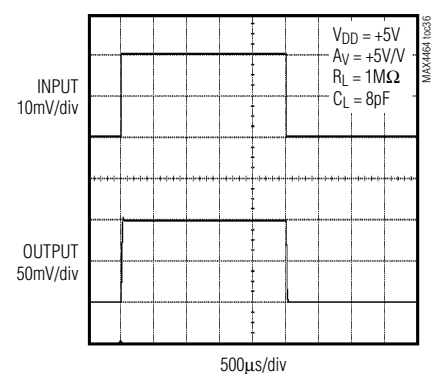

MAX4464/MAX4470/MAX4471/MAX4472/MAX4474

Single/Dual/Quad, +1.8V/750nA, SC70, Rail-to-Rail Op Amps

Typical Operating Characteristics (continued)

($V_{DD} = +5V$, $V_{SS} = 0V$, $V_{CM} = 0V$, $R_L = 100k\Omega$ to $V_{DD}/2$, $T_A = +25^\circ C$, unless otherwise noted.)

MAX4464/MAX4474
SMALL-SIGNAL STEP RESPONSE

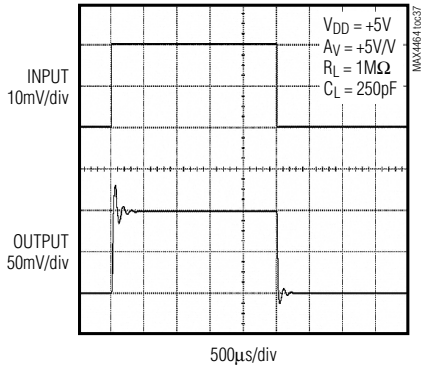

MAX4464/MAX4474
SMALL-SIGNAL STEP RESPONSE

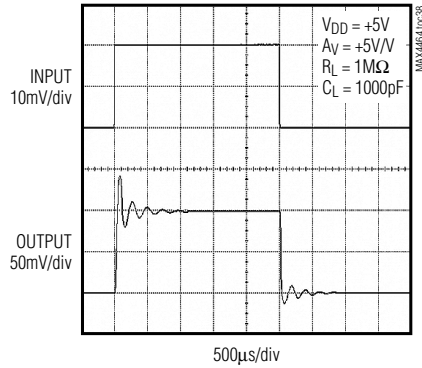

MAX4464/MAX4474
LARGE-SIGNAL STEP RESPONSE

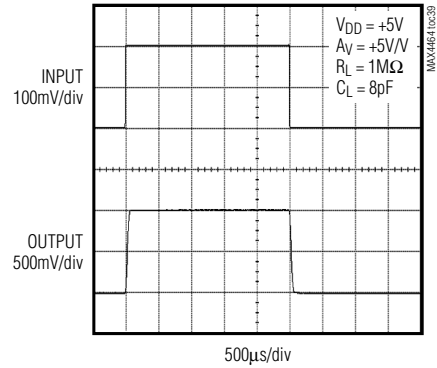

MAX4464/MAX4474
LARGE-SIGNAL STEP RESPONSE

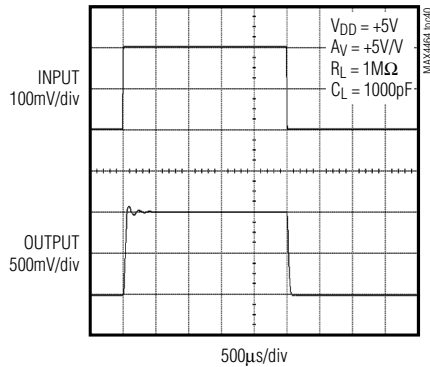

MAX4464/MAX4474
PERCENT OVERSHOOT vs. CAPACITIVE LOAD

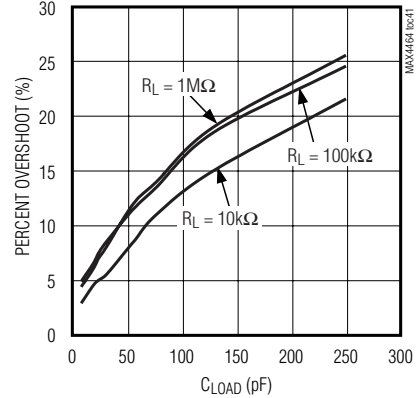

MAX4464/MAX4474
SMALL-SIGNAL NORMALIZED GAIN vs. FREQUENCY

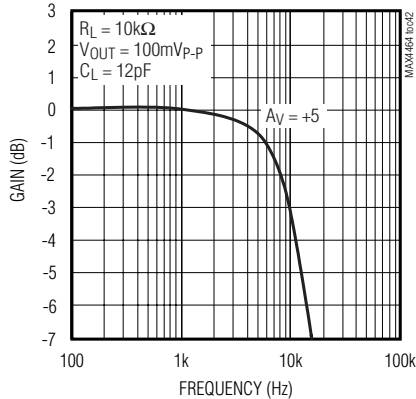

MAX4464/MAX4474
SMALL-SIGNAL NORMALIZED GAIN vs. FREQUENCY

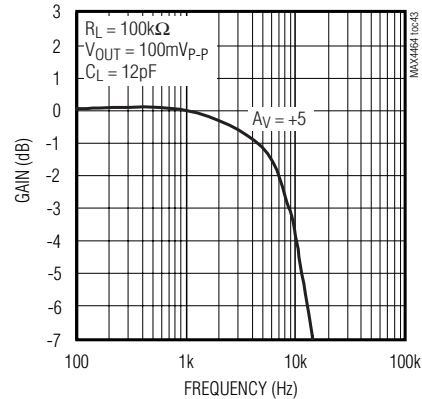

Single/Dual/Quad, +1.8V/750nA, SC70, Rail-to-Rail Op Amps

Typical Operating Characteristics (continued)

($V_{DD} = +5V$, $V_{SS} = 0V$, $V_{CM} = 0V$, $R_L = 100k\Omega$ to $V_{DD}/2$, $T_A = +25^\circ C$, unless otherwise noted.)

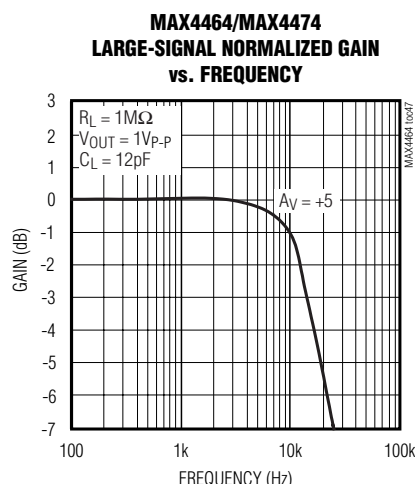
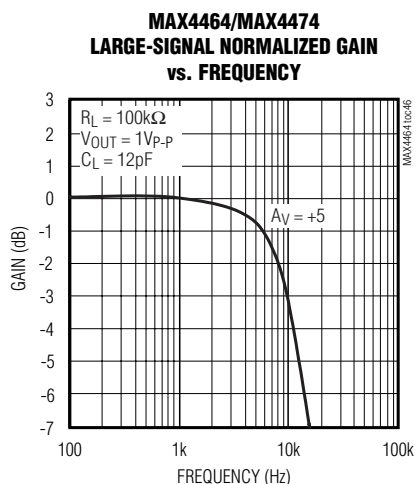
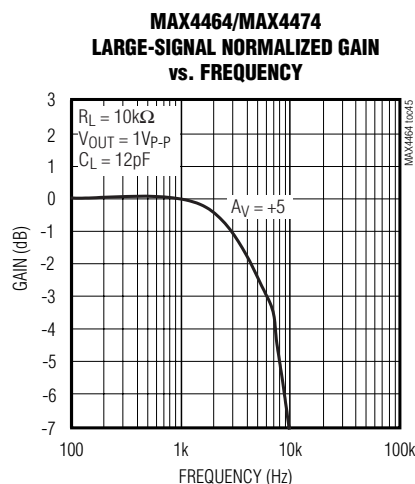
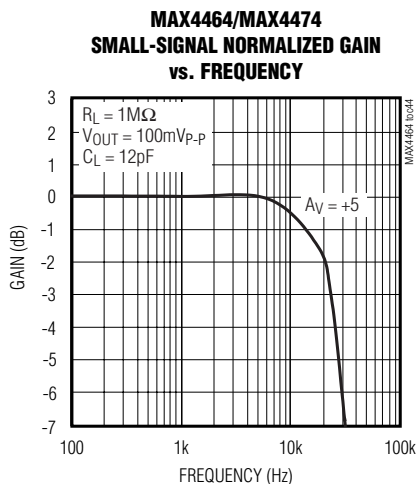

Pin Description

PIN				NAME	FUNCTION
MAX4464/ MAX4470	MAX4470 (WLP)	MAX4471/ MAX4474	MAX4472		
1	A1	—	—	IN+	Noninverting Amplifier Input
—	—	3	3	INA+	Noninverting Amplifier Input (Channel A)
2	A2	4	11	V_{SS}	Negative Power-Supply Voltage
3	B1	—	—	IN-	Inverting Amplifier Input
4	C1	—	—	OUT	Amplifier Output
—	—	2	2	INA-	Inverting Amplifier Input (Channel A)

Single/Dual/Quad, +1.8V/750nA, SC70, Rail-to-Rail Op Amps

Pin Description (continued)

PIN				NAME	FUNCTION
MAX4464/ MAX4470	MAX4470 (WLP)	MAX4471/ MAX4474	MAX4472		
—	—	1	1	OUTA	Amplifier Output (Channel A)
—	—	6	6	INB-	Inverting Amplifier Input (Channel B)
—	—	5	5	INB+	Noninverting Amplifier Input (Channel B)
—	—	7	7	OUTB	Amplifier Output (Channel B)
—	—	—	9	INC-	Inverting Amplifier Input (Channel C)
—	—	—	10	INC+	Noninverting Amplifier Input (Channel C)
—	—	—	8	OUTC	Amplifier Output (Channel C)
—	—	—	13	IND-	Inverting Amplifier Input (Channel D)
—	—	—	12	IND+	Noninverting Amplifier Input (Channel D)
—	—	—	14	OUTD	Amplifier Output (Channel D)
5	B2	8	4	V _{DD}	Positive Power-Supply Voltage
—	C2	—	—	N.C.	No Connection. Not internally connected.

Applications Information

Ground Sensing

The common-mode input range of the MAX4470 family extends down to ground, and offers excellent common-mode rejection. These devices are guaranteed not to undergo phase reversal when the input is overdriven.

Power Supplies and Layout

The MAX4470 family operates from a single +1.8V to +5.5V power supply. Bypass power supplies with a 0.1µF ceramic capacitor placed close to the V_{DD} pin.

Ground layout improves performance by decreasing the amount of stray capacitance and noise at the op amp's inputs and outputs. To decrease stray capacitance, minimize PC board lengths and resistor leads, and place external components close to the op amps' pins.

Bandwidth

The MAX4470/MAX4471/MAX4472 are internally compensated for unity-gain stability and have a typical gain-bandwidth of 9kHz. The MAX4464/MAX4474 have a 40kHz typical gain-bandwidth and are stable for a gain of +5V/V or greater.

Stability

The MAX4464/MAX4470/MAX4471/MAX4472/MAX4474 maintain stability in their minimum gain configuration while driving capacitive loads. Although this product family is primarily designed for low-frequency applications, good layout is extremely important because low-power requirements demand high-impedance circuits. The layout should also minimize stray capacitance at the amplifier inputs. However some stray capacitance may be unavoidable, and it may be necessary to add a 2pF to 10pF capacitor across the feedback resistor as shown in Figure 1. Select the smallest capacitor value that ensures stability.

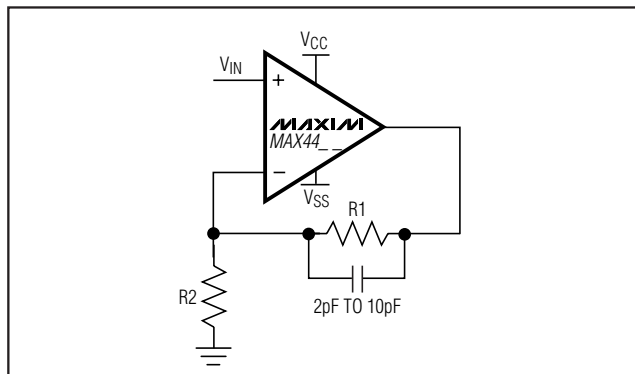
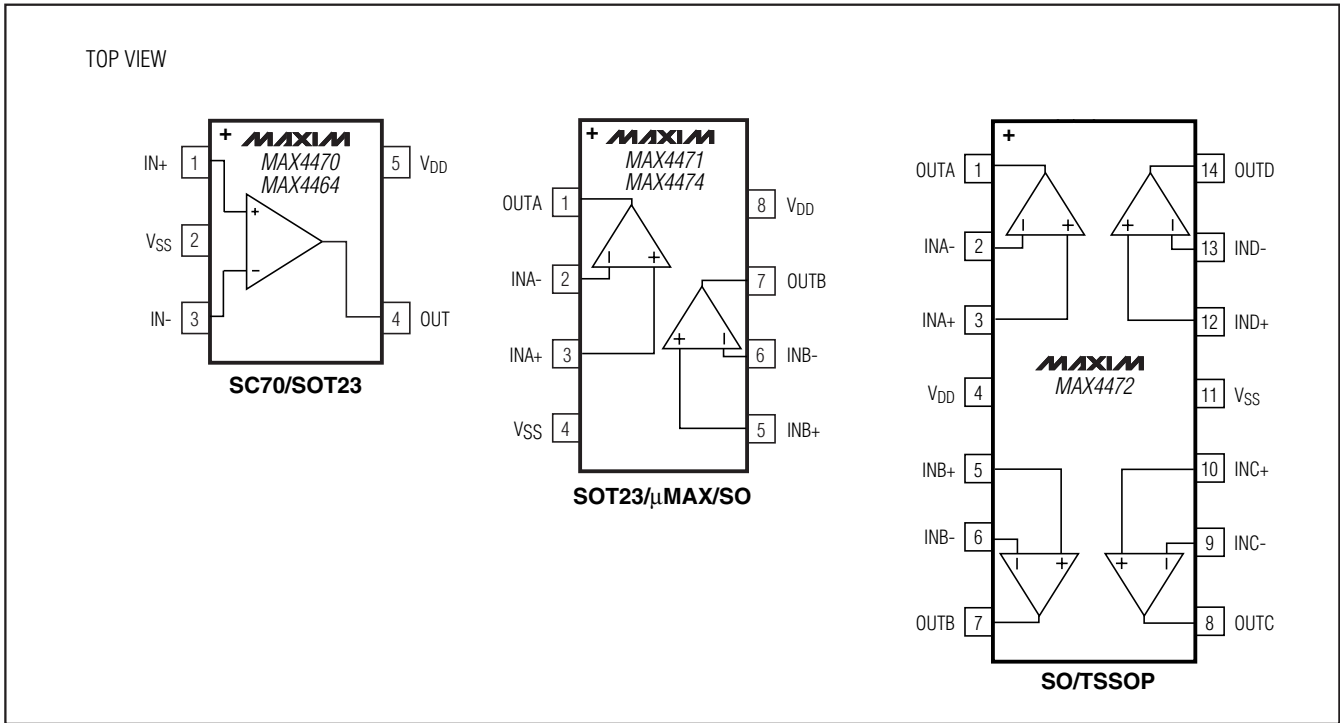

Figure 1. Compensation for Feedback Node Capacitance

Single/Dual/Quad, +1.8V/750nA, SC70, Rail-to-Rail Op Amps

Pin Configurations (continued)



Chip Information

PROCESS: BiCMOS

MAX4464/MAX4470/MAX4471/MAX4472/MAX4474

Single/Dual/Quad, +1.8V/750nA, SC70, Rail-to-Rail Op Amps

Package Information

For the latest package outline information and land patterns (footprints), go to www.maxim-ic.com/packages. Note that a "+", "#", or "-" in the package code indicates RoHS status only. Package drawings may show a different suffix character, but the drawing pertains to the package regardless of RoHS status.

PACKAGE TYPE	PACKAGE CODE	DOCUMENT NO.	LAND PATTERN NO.
5 SC70	X5+1	21-0076	90-0188
5 SOT23	U5+1	21-0057	90-0174
6 WLP	W61B1+1	21-0217	Refer to Application Note 1891
8 μ MAX	U8+1	21-0036	90-0092
8 SOT23	K8+5	21-0078	90-0176
8 SOIC	S8+2	21-0041	90-0096
14 SOIC	S14+1	21-0041	90-0096
14 TSSOP	U14+1	21-0066	90-0117

TOP VIEW

END VIEW

SIDE VIEW

COMMON DIMENSIONS			
SYMBOL	MIN	NDM	MAX
A	0.80	0.95	1.10
A1	0.00	0.07	0.10
A2	0.80	0.90	1.00
b	0.15	0.22	0.30
c	0.10	0.14	0.18
D	1.80	2.00	2.20
e	0.65 BSC.		
E	1.15	1.25	1.35
HE	1.80	2.20	2.40
L	0.26	0.34	0.46
L1	0.425 TYP.		
Q1	0.10	0.25	0.40

NOTES:

1. ALL DIMENSIONS ARE IN MILLIMETERS UNLESS OTHERWISE SPECIFIED.
2. DIMENSIONS ARE INCLUSIVE OF PLATING.
3. DIMENSIONS ARE EXCLUSIVE OF MOLD FLASH & METAL BURR.
4. COPLANARITY: 4 MILS. MAX.
5. FOOT LENGTH MEASURED AT INTERCEPT POINT BETWEEN DATUM "A" AND LEAD SURFACE.
6. MARKING IS FOR PACKAGE ORIENTATION REFERENCE ONLY.
7. LEAD CENTERLINES TO BE AT TRUE POSITION AS DEFINED BY BASIC DIMENSION "e", ± 0.05 .
8. COMPLY TO JEITA SC-88A EXCEPT FOR DIMENSION "L". ALL DIMENSIONS COMPLY TO JEDEC MO-203.
9. MATERIAL MUST COMPLY WITH BANNED AND RESTRICTED SUBSTANCES SPEC # 10-0131.
10. ALL DIMENSIONS APPLY TO BOTH LEADED (-) AND LEAD FREE (+) PACKAGE CODES.
11. PKG CODE: X5-1

-DRAWING NOT TO SCALE-

TITLE:
PACKAGE OUTLINE,
5L SC70

APPROVAL	DOCUMENT CONTROL NO. 21-0076	REV. F	1/1
----------	---------------------------------	-----------	-----

Single/Dual/Quad, +1.8V/750nA, SC70, Rail-to-Rail Op Amps

Package Information (continued)

For the latest package outline information and land patterns (footprints), go to www.maxim-ic.com/packages. Note that a "+", "#", or "-" in the package code indicates RoHS status only. Package drawings may show a different suffix character, but the drawing pertains to the package regardless of RoHS status.

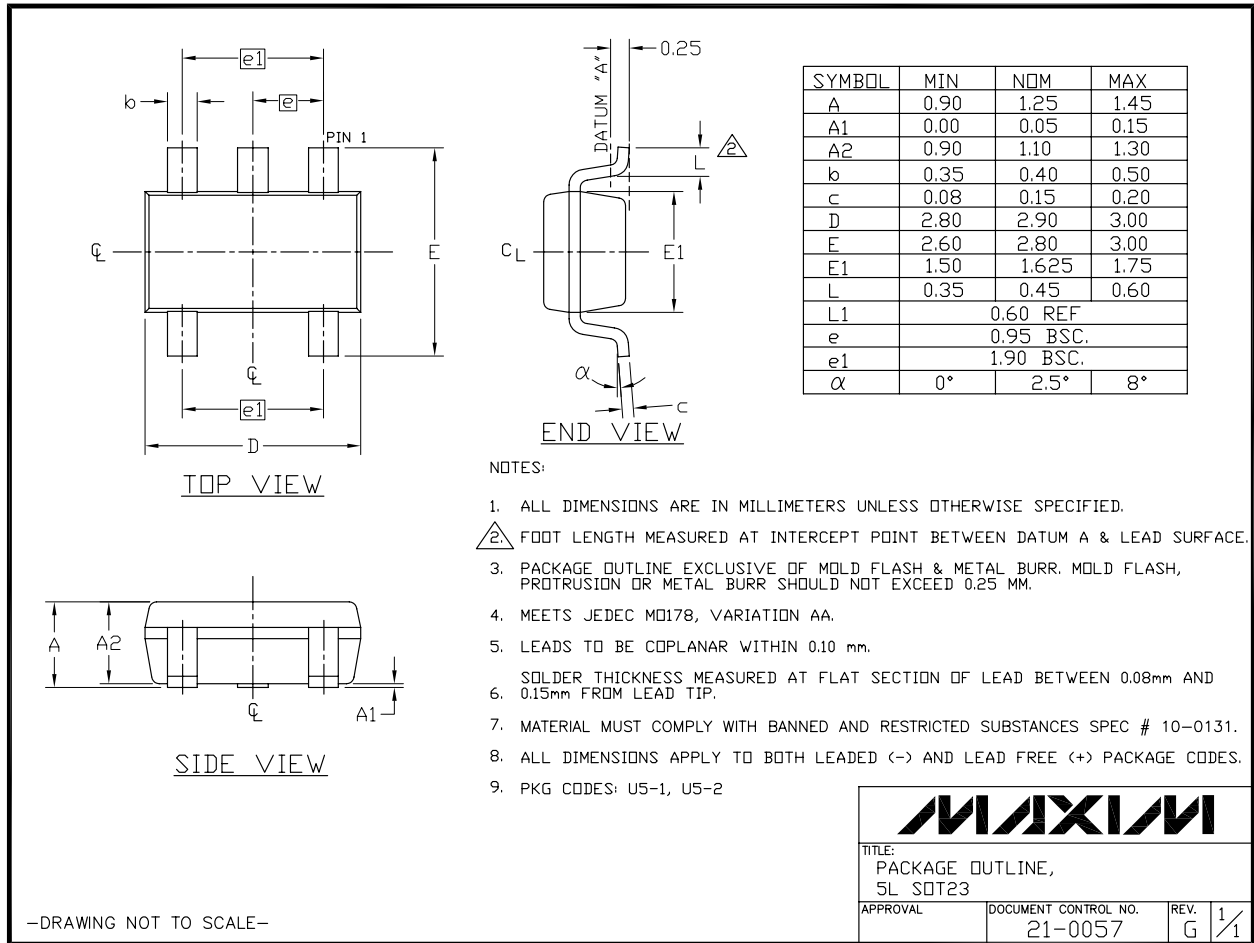

MAX4464/MAX4470/MAX4471/MAX4472/MAX4474

Single/Dual/Quad, +1.8V/750nA, SC70, Rail-to-Rail Op Amps

Package Information (continued)

For the latest package outline information and land patterns (footprints), go to www.maxim-ic.com/packages. Note that a "+", "#", or "-" in the package code indicates RoHS status only. Package drawings may show a different suffix character, but the drawing pertains to the package regardless of RoHS status.

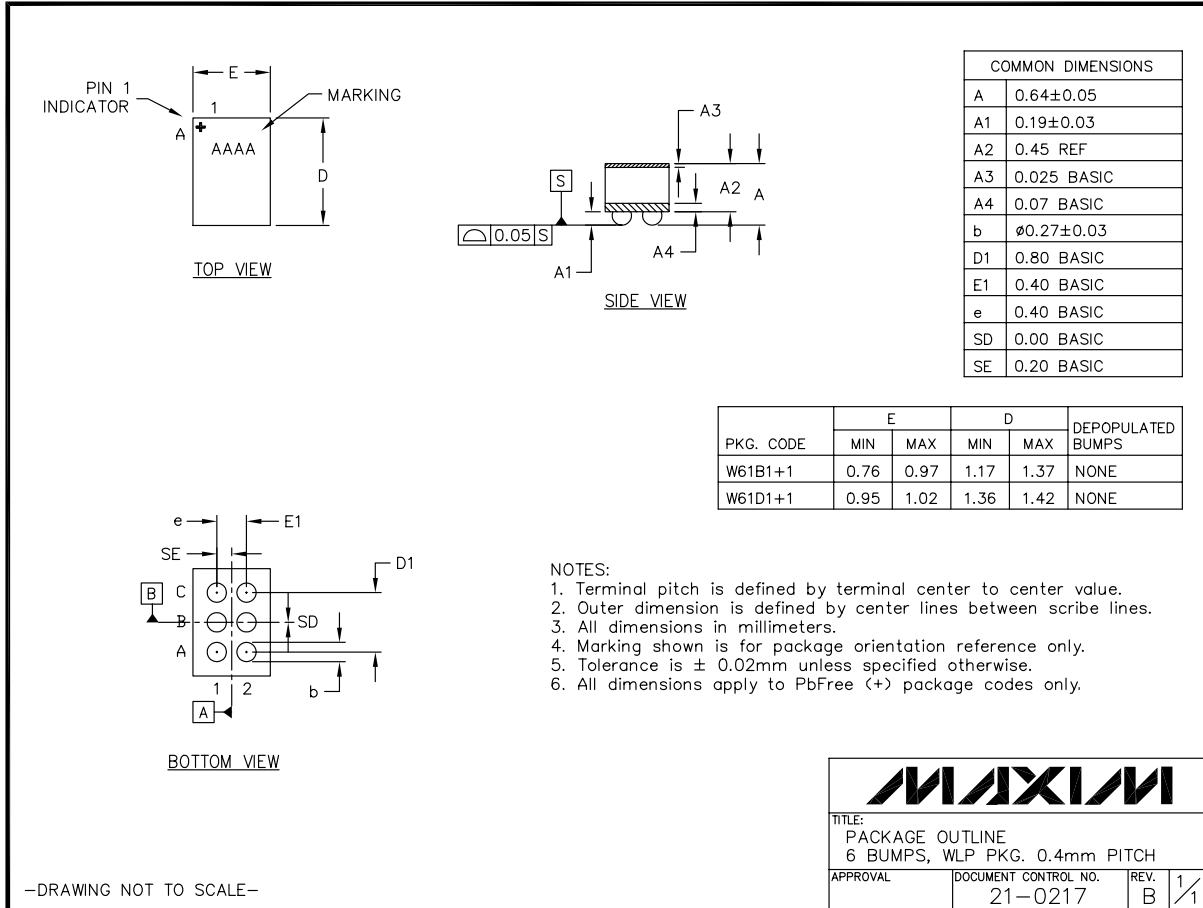

Single/Dual/Quad, +1.8V/750nA, SC70, Rail-to-Rail Op Amps

Package Information (continued)

For the latest package outline information and land patterns (footprints), go to www.maxim-ic.com/packages. Note that a "+", "#", or "-" in the package code indicates RoHS status only. Package drawings may show a different suffix character, but the drawing pertains to the package regardless of RoHS status.

MAX4464/MAX4470/MAX4471/MAX4472/MAX4474

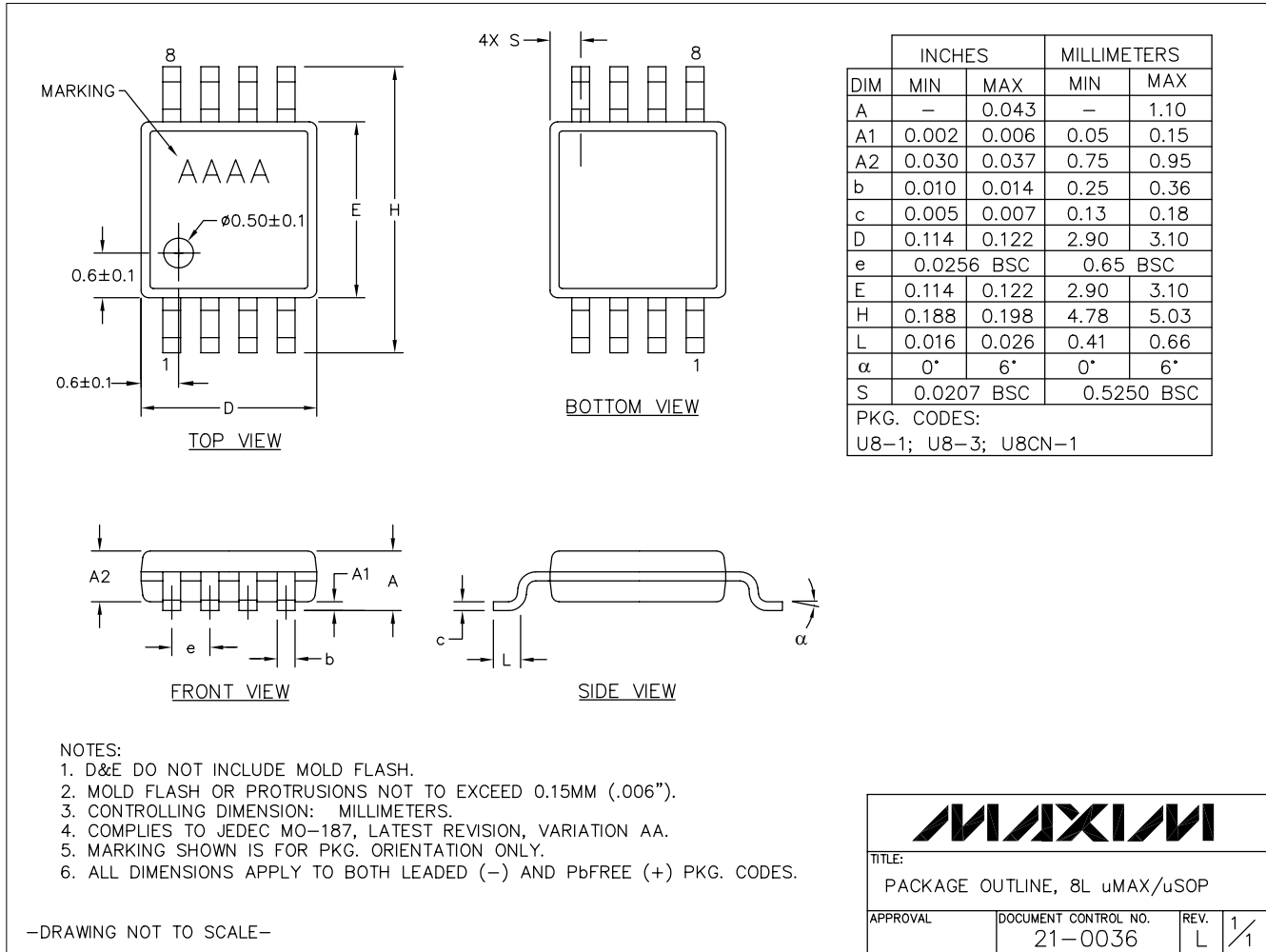

Single/Dual/Quad, +1.8V/750nA, SC70, Rail-to-Rail Op Amps

Package Information (continued)

For the latest package outline information and land patterns (footprints), go to www.maxim-ic.com/packages. Note that a "+", "#", or "-" in the package code indicates RoHS status only. Package drawings may show a different suffix character, but the drawing pertains to the package regardless of RoHS status.

SYMBOL	MIN	NOM	MAX
A	0.90	1.25	1.45
A1	0.00	0.06	0.15
A2	0.90	1.10	1.30
b	0.22	0.30	0.38
C	0.08	0.15	0.22
D	2.80	2.90	3.00
E	2.60	2.80	3.00
E1	1.50	1.625	1.75
L	0.30	0.45	0.60
L2	0.25 BSC.		
e	0.65 BSC.		
e1	1.95 REF.		
θ	0°	3°	8°

PKG CODES:
K8-1, K8-2, K8F-4, K8FH-4, K8-5,
K8SN-1; K8CN-2

NOTE:
1. ALL DIMENSIONS ARE IN MILLIMETERS.
2. FOOT LENGTH MEASURED FROM LEAD TIP TO UPPER RADIUS OF HEEL OF THE LEAD PARALLEL TO SEATING PLANE C.
3. PACKAGE OUTLINE EXCLUSIVE OF MOLD FLASH & METAL BURR.
4. PACKAGE OUTLINE INCLUSIVE OF SOLDER PLATING.
5. COPLANARITY 4 MILS. MAX.
6. MARKING IS FOR PACKAGE ORIENTATION REFERENCE ONLY.
7. SOLDER THICKNESS MEASURED AT FLAT SECTION OF LEAD BETWEEN 0.08mm AND 0.15mm FROM LEAD TIP.
8. MEETS JEDEC MO178 VARIATION BA.
9. ALL DIMENSIONS APPLY TO BOTH LEADED (-) AND LEAD FREE (+) PACKAGE CODES.

—DRAWING NOT TO SCALE—

MAXIM			
TITLE: PACKAGE OUTLINE, SOT-23, 8L BODY			
APPROVAL	DOCUMENT CONTROL NO. 21-0078	REV. J	1/1

Single/Dual/Quad, +1.8V/750nA, SC70, Rail-to-Rail Op Amps

Package Information (continued)

For the latest package outline information and land patterns (footprints), go to www.maxim-ic.com/packages. Note that a "+", "#", or "-" in the package code indicates RoHS status only. Package drawings may show a different suffix character, but the drawing pertains to the package regardless of RoHS status.

MAX4464/MAX4470/MAX4471/MAX4472/MAX4474

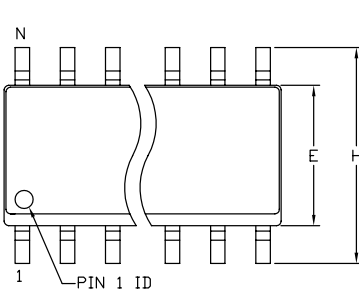

TOP VIEW

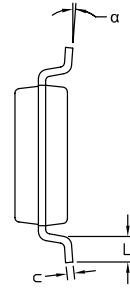

END VIEW

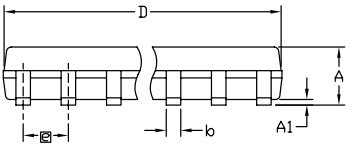

SIDE VIEW

SYMBOL	INCHES		MM	
	MIN.	MAX.	MIN.	MAX.
A	.053	.069	1.35	1.75
A1	.004	.010	0.10	0.25
b	.014	.019	0.35	0.49
c	.007	.010	0.19	0.25
E	.150	.157	3.80	4.00
e	.050 BSC		1.27 BSC	
H	.228	.244	5.80	6.20
L	.016	.050	0.40	1.27
alpha	0°	8°	0°	8°

VARIATION A				
SYMBOL	INCHES		MM	
	MIN.	MAX.	MIN.	MAX.
D	.189	.197	4.80	5.00
N	8			
MS012	AA			
PKG. CODE	S8-2, S8-4, S8-5, S8-6F, S8-7F, S8-8F, S8-10F, S8-11F, S8-16F			

VARIATION B				
SYMBOL	INCHES		MM	
	MIN.	MAX.	MIN.	MAX.
D	.337	.344	8.55	8.75
N	14			
MS012	AB			
PKG. CODE	S14-1, S14-4, S14-5, S14-6, S14M-4, S14M-5, S14M-6, S14M-7			

VARIATION C				
SYMBOL	INCHES		MM	
	MIN.	MAX.	MIN.	MAX.
D	.386	.394	9.80	10.00
N	16			
MS012	AC			
PKG. CODE	S16-1, S16-3, S16-5, S16-6, S16-8, S16-7F, S16-9F, S16-10F, S16M-3, S16M-6			

NOTES:

1. ALL DIMENSIONS ARE IN MILLIMETERS UNLESS OTHERWISE SPECIFIED.
2. MATERIAL MUST COMPLY WITH BANNED AND RESTRICTED SUBSTANCES SPEC # 10-0131.
3. DIMENSIONS D AND E DO NOT INCLUDE MOLD PROTRUSION. ALLOWABLE MOLD PROTRUSION IS 0.15 MM (.006") PER SIDE.
4. LEADS TO BE COPLANAR WITHIN 0.10mm (.004").
5. MEETS JEDEC MS012
6. ALL DIMENSIONS APPLY TO BOTH LEADED (-) AND PbfREE (+) PKG. CODES.

-DRAWING NOT TO SCALE-

MAXIM

TITLE:
PACKAGE OUTLINE,
8L, 14L, 16L SDIC .150 INCH

APPROVAL	DOCUMENT CONTROL NO. 21-0041	REV. C 1/1
----------	---------------------------------	------------

Single/Dual/Quad, +1.8V/750nA, SC70, Rail-to-Rail Op Amps

Package Information (continued)

For the latest package outline information and land patterns (footprints), go to www.maxim-ic.com/packages. Note that a "+", "#", or "-" in the package code indicates RoHS status only. Package drawings may show a different suffix character, but the drawing pertains to the package regardless of RoHS status.

SYMBOL	COMMON DIMENSIONS			
	MILLIMETERS		INCHES	
	MIN.	MAX.	MIN.	MAX.
A	—	1.10	—	.043
A ₁	0.05	0.15	.002	.006
A ₂	0.85	0.95	.033	.037
b	0.19	0.30	.007	.012
b ₁	0.19	0.25	.007	.010
c	0.09	0.20	.004	.008
c ₁	0.09	0.14	.004	.006
D	SEE VARIATIONS		SEE VARIATIONS	
E	4.30	4.50	.169	.177
e	0.65 BSC		.026 BSC	
H	6.25	6.55	.246	.258
L	0.50	0.70	.020	.028
N	SEE VARIATIONS		SEE VARIATIONS	
α	0°		8°	
kbb	0.10 MAX			

JEDEC MO-153	N	SYMBOL	PKG. CODES	VARIATIONS			
				MILLIMETERS		INCHES	
				MIN.	MAX.	MIN.	MAX.
AB-1	14	D	U14-1, U14-2, U14-3	4.90	5.10	.193	.201
AB	16	D	U16-1, U16-2, U16-1F, U16M-1	4.90	5.10	.193	.201
AC	20	D	U20-1, U20-2, U20-3, U20-5, U20-1F, U20M-2	6.40	6.60	.252	.260
AD	24	D	U24-1, U24-2	7.70	7.90	.303	.311
AE	28	D	U28-1, U28-2, U28-3	9.60	9.80	.378	.386

NOTES

- DIMENSIONS D AND E DO NOT INCLUDE FLASH
- MOLD FLASH OR PROTRUSIONS NOT TO EXCEED 0.15mm PER SIDE
- CONTROLLING DIMENSION: MILLIMETER
- MEETS JEDEC OUTLINE MO-153. SEE JEDEC VARIATIONS TABLE
- "N" REFERS TO NUMBER OF LEADS
- LEAD COPLANARITY 0.10 MM MAX.
- NUMBER OF LEADS SHOWN ARE FOR REFERENCE ONLY
- MARKING IS FOR PACKAGE ORIENTATION REFERENCE ONLY
- BENT LEAD 0.10 MM MAX.
- MATERIAL MUST COMPLY WITH BANNED AND RESTRICTED SUBSTANCES SPEC # 10-0131.
- ALL DIMENSIONS APPLY TO BOTH LEADED (-) AND PBFREE (+) PKG. CODES.

-DRAWING NOT TO SCALE-

MAXIM

TITLE:
PACKAGE OUTLINE,
TSSOP 4.40mm BODY

APPROVAL	DOCUMENT CONTROL NO. 21-0066	REV. L 1/1
----------	---------------------------------	---------------

Single/Dual/Quad, +1.8V/750nA, SC70, Rail-to-Rail Op Amps

Revision History

REVISION NUMBER	REVISION DATE	DESCRIPTION	PAGES CHANGED
3	6/10	Added WLP package	1, 2, 9, 10, 11
4	7/11	Updated power-on time specification	3

MAX4464/MAX4470/MAX4471/MAX4472/MAX4474

Maxim cannot assume responsibility for use of any circuitry other than circuitry entirely embodied in a Maxim product. No circuit patent licenses are implied. Maxim reserves the right to change the circuitry and specifications without notice at any time.

Maxim Integrated Products, 120 San Gabriel Drive, Sunnyvale, CA 94086 408-737-7600 _____ 19