



### Features

- Ultra small package: 0.6x0.3x0.3mm
- Protects one data or power line
- Ultra low leakage: nA level
- Low operating voltage: 5V
- Low clamping voltage
- 2-pin leadless package
- Complies with following standards:
  - IEC 61000-4-2 (ESD) immunity test  
Air discharge: ±30kV  
Contact discharge: ±30kV
  - IEC61000-4-4 (EFT) 40A (5/50ns)
  - IEC61000-4-5 (Lightning) 5A (8/20µs)
- RoHS Compliant

### Applications

- Cellular Handsets and Accessories
- Personal Digital Assistants
- Notebooks and Handhelds
- Portable Instrumentation
- Digital Cameras
- Peripherals
- Audio Players
- Keypads, Side Keys, LCD Displays

### Mechanical Characteristics

- Package: 0201
- Lead Finish: Sn
- Case Material: "Green" Molding Compound.
- UL Flammability Classification Rating 94V-0
- Moisture Sensitivity: Level 3 per J-STD-020
- Terminal Connections: See Diagram Below
- Marking Information: See Below

### Absolute Maximum Ratings (Tamb=25°C unless otherwise specified)

Parameter	Symbol	Value	Unit
Peak Pulse Power (8/20µs)	Ppp	60	W
ESD per IEC 61000-4-2 (Air)	VESD	± 30	Kv
ESD per IEC 61000-4-2 (Contact)		± 30	
Operating Temperature Range	TJ	-55 to +125	°C
Storage Temperature Range	TSTJ	-55 to +150	°C

### Dimensions 0201

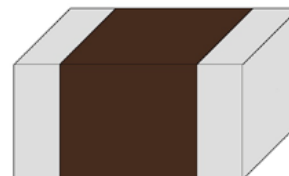

### Pin Configuration

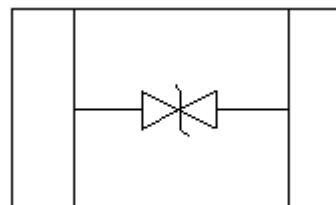

**Electrical Characteristics** (TA=25°C unless otherwise specified)

Part Number	Device Marking	V <sub>RWM</sub> (V)	V <sub>BR</sub> (V)	I <sub>T</sub> (mA)	V <sub>C</sub> @1A	V <sub>C</sub>		I <sub>R</sub> μA (Max)	C (Pf) (Typ.)
						(Max)	(@A)		
ESD0521C		5	6	1	8	12	5	0.2	10

Typical Performance Characteristics ( $T_A=25^\circ\text{C}$  unless otherwise Specified)

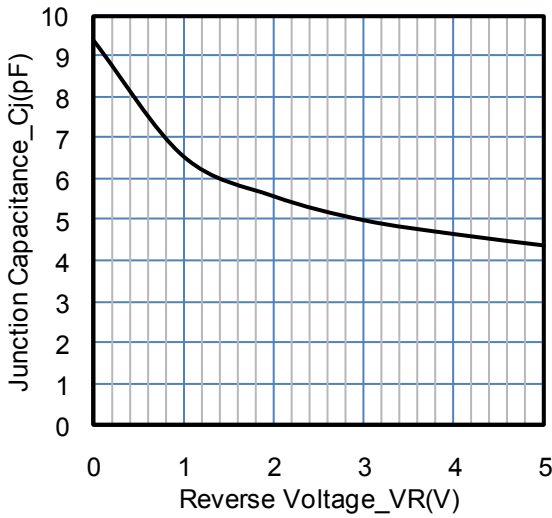

Junction Capacitance vs. Reverse Voltage

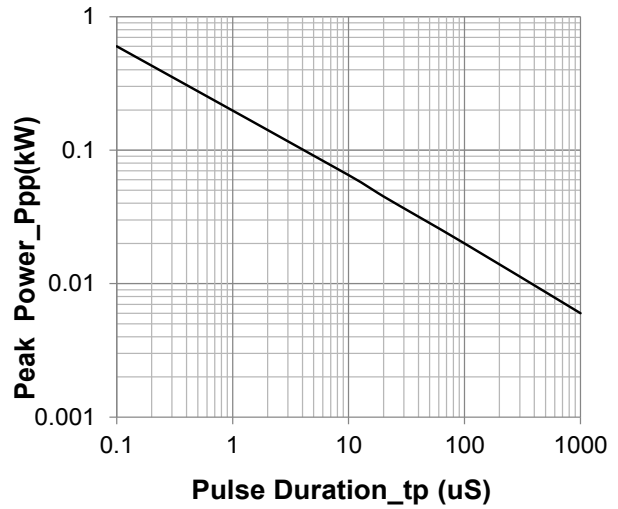

Peak Pulse Power vs. Pulse Time

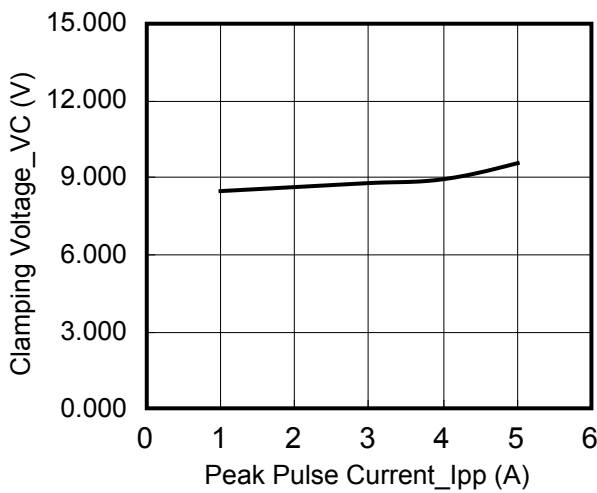

Clamping Voltage vs. Peak Pulse Current ( $t_p = 8/20\mu\text{s}$ )

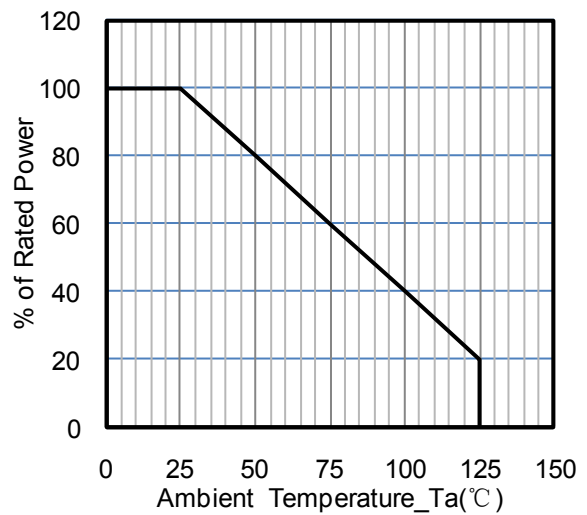

Power Derating Curve

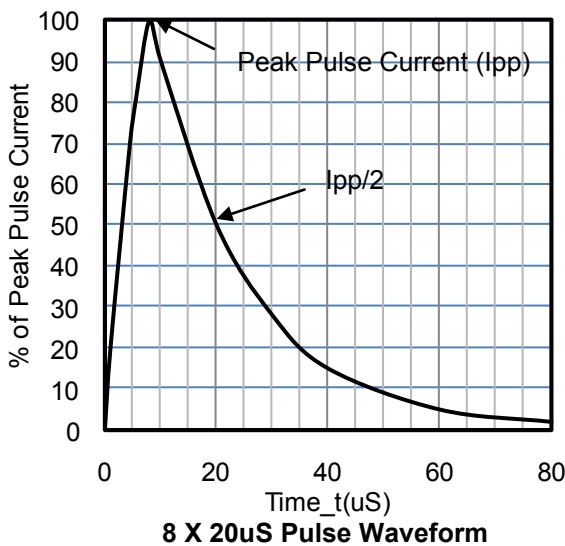

8 X 20uS Pulse Waveform

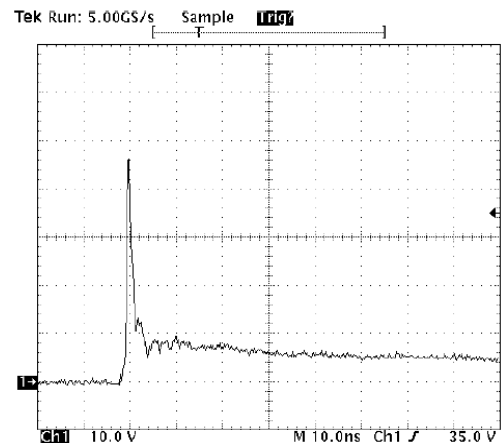

ESD Clamping Voltage  
8 kV Contact per IEC61000-4-2

**0201 PACKAGE OUTLINE & DIMENSIONS**

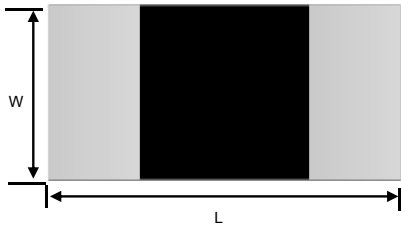

Top View

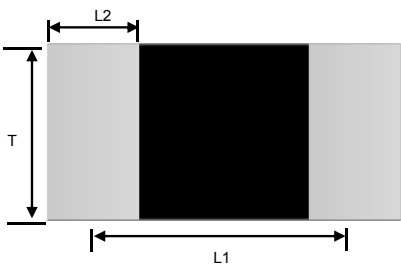

Side View

SYM	DIMENSIONS					
	MILLIMETERS			INCHES		
	MIN	NOM	MAX	MIN	NOM	MAX
W	0.25	0.30	0.35	0.010	0.012	0.014
L	0.55	0.60	0.65	0.022	0.024	0.026
T	0.25	0.30	0.35	0.010	0.012	0.014
L1	0.30 BSC			0.012 BSC		
L2	0.10	0.15	0.20	0.004	0.006	0.008

**Suggested Land Pattern**

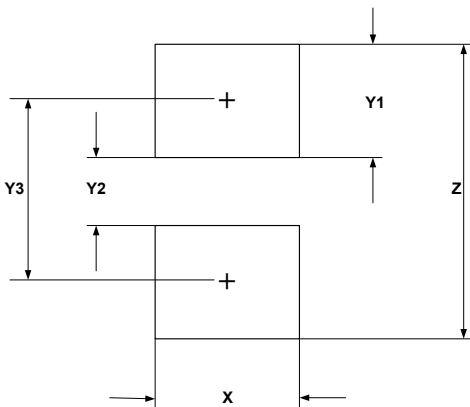

SYM	DIMENSIONS	
	MILLIMETERS	INCHES
X	0.30	0.012
Y1	0.25	0.010
Y2	0.30	0.012
Y3	0.55	0.022
Z	0.80	0.032