



SGM8581

Single-Supply, Single Rail-to-Rail I/O Precision Operational Amplifier

PRODUCT DESCRIPTION

The SGM8581 is a single rail-to-rail input and output precision operational amplifier which has low input offset voltage, and bias current. It is guaranteed to operate from 2.5V to 5.5V single supply.

The rail-to-rail input and output swings provided by the SGM8581 make both high-side and low-side sensing easy. The combination of characteristics makes the SGM8581 good choices for temperature, position and pressure sensors, medical equipment and strain gauge amplifiers, or any other 2.5V to 5.5V application requiring precision and long term stability.

The SGM8581 is specified for the extended industrial/automotive (-40°C to +125°C) temperature range. The SGM8581 is available in the Green SOT-23-5, SOIC-8 and MSOP-8 packages.

APPLICATIONS

- Temperature Measurements
- Pressure Sensors
- Precision Current Sensing
- Electronic Scales
- Strain Gauge Amplifiers
- Medical Instrumentation
- Thermocouple Amplifiers
- Handheld Test Equipment

FEATURES

- **Low Offset Voltage: 25 μ V (TYP)**
- **Rail-to-Rail Input and Output Swing**
- **2.5V to 5.5V Single Supply Operation**
- **Voltage Gain: 145dB (TYP) at +5V**
- **PSRR: 120dB (TYP)**
- **CMRR: 90dB (TYP)**
- **Ultra Low Input Bias Current: 15pA**
- **Low Supply Current: 445 μ A at +5V**
- **Overload Recovery Time: 70 μ s (at $V_S = +5V$)**
- **No External Capacitors Required**
- **-40°C to +125°C Operating Temperature Range**
- **Available in Green SOT-23-5, SOIC-8 and MSOP-8 Packages**

PIN CONFIGURATIONS (Top View)

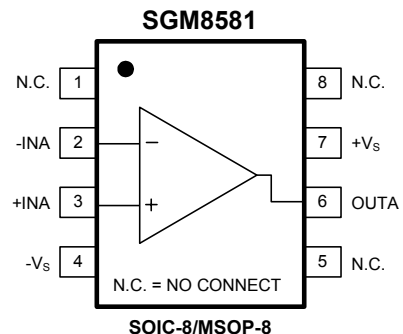
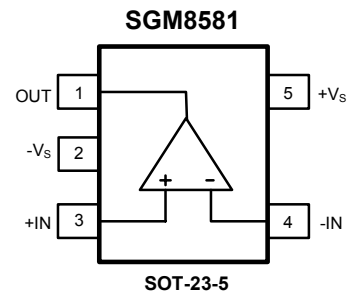

SGM8581

Single-Supply, Single Rail-to-Rail I/O Precision Operational Amplifier

PACKAGE/ORDERING INFORMATION

| MODEL | ORDER NUMBER | PACKAGE DESCRIPTION | PACKAGE OPTION | MARKING INFORMATION |
|---------|-----------------|---------------------|---------------------|---------------------|
| SGM8581 | SGM8581XN5G/TR | SOT-23-5 | Tape and Reel, 3000 | S0BXX |
| | SGM8581XS8G/TR | SOIC-8 | Tape and Reel, 2500 | SGM8581XS8 |
| | SGM8581XMS8G/TR | MSOP-8 | Tape and Reel, 3000 | SGM8581XMS8 |

NOTE: Order number and package marking are defined as the follow:

ORDER NUMBER

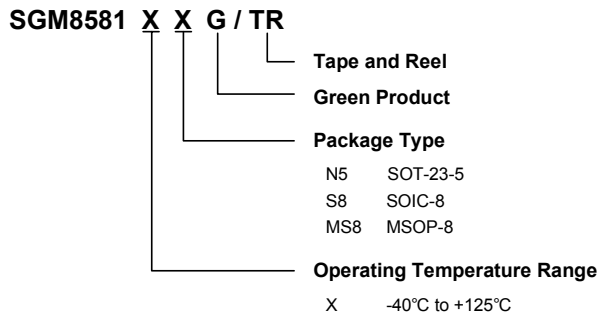

MARKING INFORMATION

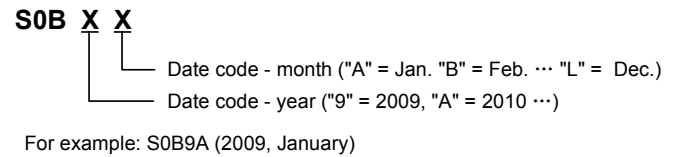

ABSOLUTE MAXIMUM RATINGS

| | |
|---|---------------------------|
| Supply Voltage | 6V |
| Input Voltage | $-V_S$ to $(+V_S) + 0.1V$ |
| Differential Input Voltage | -5V to 5V |
| Storage Temperature Range | -65°C to +150°C |
| Junction Temperature | 150°C |
| Operating Temperature Range | -40°C to +125°C |
| Lead Temperature Range (Soldering 10 sec) | 260°C |
| ESD Susceptibility | |
| HBM (SOT-23-5) | 6000V |
| HBM (SOIC-8) | 7000V |
| HBM (MSOP-8) | 6000V |
| MM | 400V |

NOTE:

Stresses beyond those listed under "Absolute Maximum Ratings" may cause permanent damage to the device. These are stress ratings only, and functional operation of the device at these or any other conditions beyond those indicated in the operational sections of the specifications is not implied. Exposure to absolute maximum rating conditions for extended periods may affect device reliability.

CAUTION

This integrated circuit can be damaged by ESD if you don't pay attention to ESD protection. SGMICRO recommends that all integrated circuits be handled with appropriate precautions. Failure to observe proper handling and installation procedures can cause damage. ESD damage can range from subtle performance degradation to complete device failure. Precision integrated circuits may be more susceptible to damage because very small parametric changes could cause the device not to meet its published specifications.

SGMICRO reserves the right to make any change in circuit design, specification or other related things if necessary without notice at any time. Please contact SGMICRO sales office to get the latest datasheet.

ELECTRICAL CHARACTERISTICS(V_S = +5V, V_{CM} = +2.5V, V_O = +2.5V, T_A = +25°C, unless otherwise noted.)

| PARAMETER | CONDITIONS | MIN | TYP | MAX | UNITS |
|--|--|-------|-------|-----|-------------------|
| INPUT CHARACTERISTICS | | | | | |
| Input Offset Voltage (V _{OS}) | | | 25 | 100 | μV |
| | -40°C ≤ T _A ≤ +125°C | | | 106 | |
| Input Bias Current (I _B) | | | 15 | | pA |
| Input Offset Current (I _{OS}) | | | 10 | | pA |
| Input Voltage Range | | 0 | | 5 | V |
| Common-Mode Rejection Ratio ⁽¹⁾ (CMRR) | V _{CM} = 0V to 5V | 80 | 90 | | dB |
| | -40°C ≤ T _A ≤ +125°C | 62 | | | |
| Large Signal Voltage Gain (A _{VO}) | R _L = 10kΩ, V _O = 0.3V to 4.7V | 95 | 145 | | dB |
| | -40°C ≤ T _A ≤ +125°C | 91 | | | |
| Input Offset Voltage Drift (ΔV _{OS} /ΔT) | -40°C ≤ T _A ≤ +125°C | | 100 | | nV/°C |
| OUTPUT CHARACTERISTICS | | | | | |
| Output Voltage High (V _{OH}) | R _L = 100kΩ to -V _S | 4.99 | 4.998 | | V |
| | -40°C ≤ T _A ≤ +125°C | 4.979 | | | |
| | R _L = 10kΩ to -V _S | 4.98 | 4.994 | | V |
| | -40°C ≤ T _A ≤ +125°C | 4.96 | | | |
| Output Voltage Low (V _{OL}) | R _L = 100kΩ to +V _S | | 2 | 10 | mV |
| | -40°C ≤ T _A ≤ +125°C | | | 11 | |
| | R _L = 10kΩ to +V _S | | 6 | 15 | mV |
| | -40°C ≤ T _A ≤ +125°C | | | 18 | |
| Short Circuit Limit (I _{SC}) | V _O = 2.5V, R _L = 10Ω to GND | 40 | 45 | | mA |
| | -40°C ≤ T _A ≤ +125°C | 26 | | | |
| POWER SUPPLY | | | | | |
| Power Supply Rejection Ratio ⁽¹⁾ (PSRR) | V _S = 2.5V to 5.5V | 90 | 120 | | dB |
| | -40°C ≤ T _A ≤ +125°C | 73 | | | |
| Quiescent Current (I _Q) | V _O = +V _S /2 | | 445 | 700 | μA |
| | -40°C ≤ T _A ≤ +125°C | | | 845 | |
| DYNAMIC PERFORMANCE | | | | | |
| Gain-Bandwidth Product (GBP) | A _V = +100 | | 1.45 | | MHz |
| Slew Rate (SR) | A _V = +1, R _L = 10kΩ, 2V Output Step | | 0.75 | | V/μs |
| Overload Recovery Time | A _V = -100, R _L = 10kΩ, V _{IN} = 200mV (RET to GND) | | 0.07 | | ms |
| NOISE PERFORMANCE | | | | | |
| Voltage Noise (e _n p-p) | 0.1Hz to 10Hz | | 0.85 | | μV _{P-P} |
| Voltage Noise Density (e _n) | f = 1kHz | | 47.5 | | nV/√Hz |

NOTE 1: PSRR and CMRR are affected by the matching between external gain-setting resistor ratios.

ELECTRICAL CHARACTERISTICS(V_S = +2.5V, V_{CM} = +1.25V, V_O = +1.25V, T_A = +25°C, unless otherwise noted.)

| PARAMETER | CONDITIONS | MIN | TYP | MAX | UNITS |
|--|--|-------|-------|-----|-------------------|
| INPUT CHARACTERISTICS | | | | | |
| Input Offset Voltage (V _{OS}) | | | 25 | 100 | μV |
| | -40°C ≤ T _A ≤ +125°C | | | 127 | |
| Input Bias Current (I _B) | | | 15 | | pA |
| Input Offset Current (I _{OS}) | | | 10 | | pA |
| Input Voltage Range | | 0 | | 2.5 | V |
| Common-Mode Rejection Ratio ⁽¹⁾ (CMRR) | V _{CM} = 0V to 2.5V | 75 | 90 | | dB |
| | -40°C ≤ T _A ≤ +125°C | 61 | | | |
| Large Signal Voltage Gain (A _{VO}) | R _L = 10kΩ, V _O = 0.3V to 2.4V | 95 | 140 | | dB |
| | -40°C ≤ T _A ≤ +125°C | 91 | | | |
| Input Offset Voltage Drift (ΔV _{OS} /ΔT) | -40°C ≤ T _A ≤ +125°C | | 150 | | nV/°C |
| OUTPUT CHARACTERISTICS | | | | | |
| Output Voltage High (V _{OH}) | R _L = 100kΩ to -V _S | 2.49 | 2.498 | | V |
| | -40°C ≤ T _A ≤ +125°C | 2.473 | | | |
| | R _L = 10kΩ to -V _S | 2.48 | 2.497 | | V |
| | -40°C ≤ T _A ≤ +125°C | 2.46 | | | |
| Output Voltage Low (V _{OL}) | R _L = 100kΩ to +V _S | | 1 | 10 | mV |
| | -40°C ≤ T _A ≤ +125°C | | | 11 | |
| | R _L = 10kΩ to +V _S | | 3 | 15 | mV |
| | -40°C ≤ T _A ≤ +125°C | | | 16 | |
| Short Circuit Limit (I _{SC}) | V _O = 1.25V, R _L = 10Ω to GND | 20 | 27 | | mA |
| | -40°C ≤ T _A ≤ +125°C | 14 | | | |
| POWER SUPPLY | | | | | |
| Power Supply Rejection Ratio ⁽¹⁾ (PSRR) | V _S = 2.5V to 5.5V | 90 | 120 | | dB |
| | -40°C ≤ T _A ≤ +125°C | 73 | | | |
| Quiescent Current (I _Q) | V _O = +V _S /2 | | 440 | 700 | μA |
| | -40°C ≤ T _A ≤ +125°C | | | 786 | |
| DYNAMIC PERFORMANCE | | | | | |
| Gain-Bandwidth Product (GBP) | A _V = +100 | | 1.45 | | MHz |
| Slew Rate (SR) | A _V = +1, R _L = 10kΩ, 2V Output Step | | 0.75 | | V/μs |
| Overload Recovery Time | A _V = -100, R _L = 10kΩ, V _{IN} = 200mV (RET to GND) | | 0.04 | | ms |
| NOISE PERFORMANCE | | | | | |
| Voltage Noise (e _n p-p) | 0.1Hz to 10Hz | | 0.9 | | μV _{P-P} |
| Voltage Noise Density (e _n) | f = 1kHz | | 77 | | nV/√Hz |

NOTE 1: PSRR and CMRR are affected by the matching between external gain-setting resistor ratios.

TYPICAL PERFORMANCE CHARACTERISTICS

Large Signal Transient Response at +5V

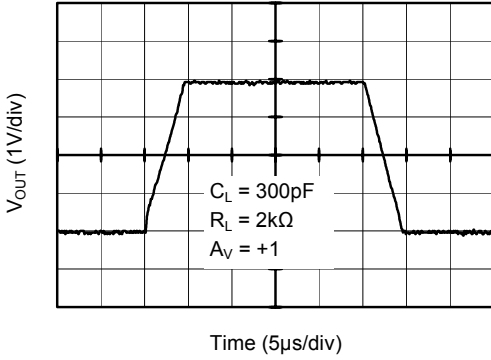

Large Signal Transient Response at +2.5V

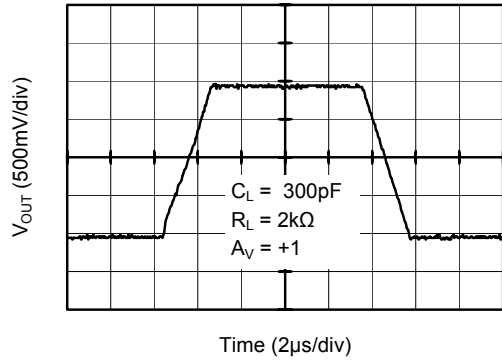

Small Signal Transient Response at +5V

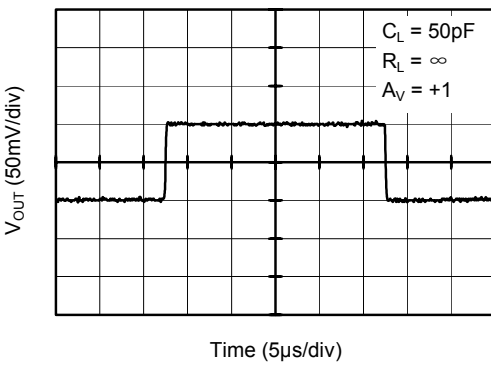

Small Signal Transient Response at +2.5V

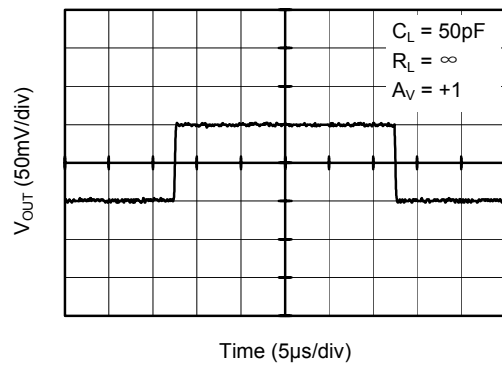

Closed Loop Gain vs. Frequency at +5V

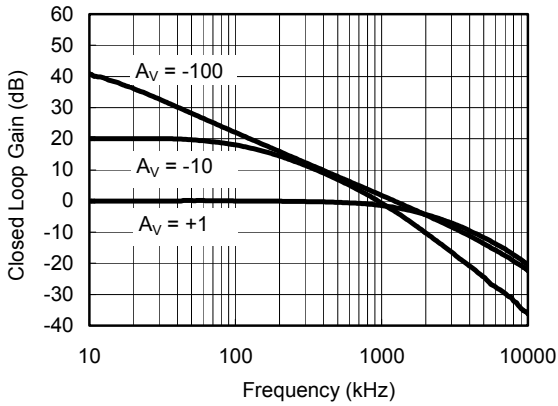

Closed Loop Gain vs. Frequency at +2.5V

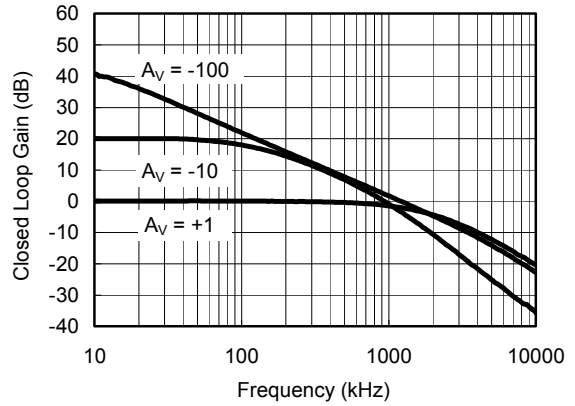

TYPICAL PERFORMANCE CHARACTERISTICS

0.1Hz to 10Hz Noise at +5V

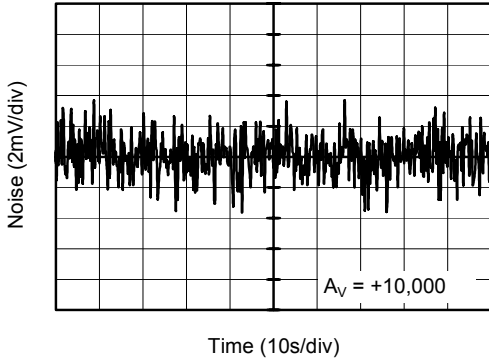

0.1Hz to 10Hz Noise at +2.5V

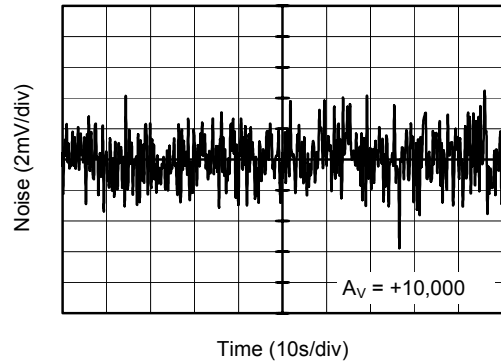

Negative Overvoltage Recovery

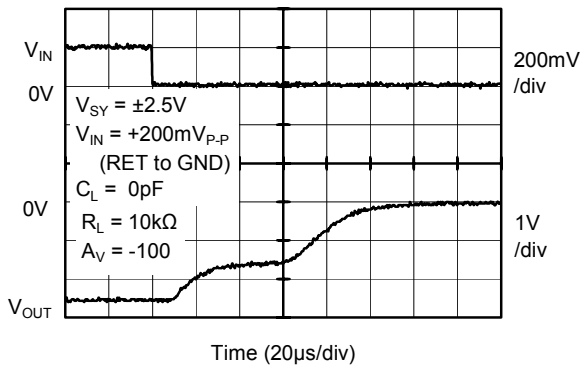

Positive Overvoltage Recovery

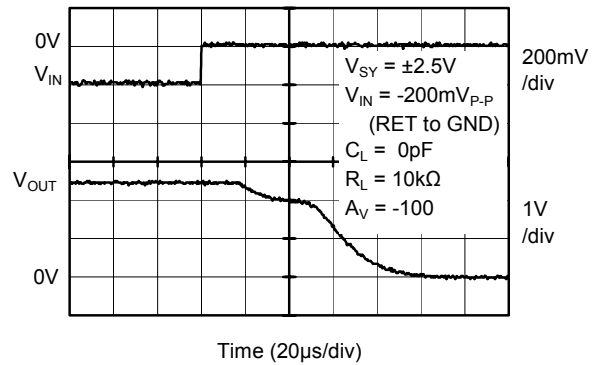

Open Loop Gain, Phase Shift vs. Frequency at +5V

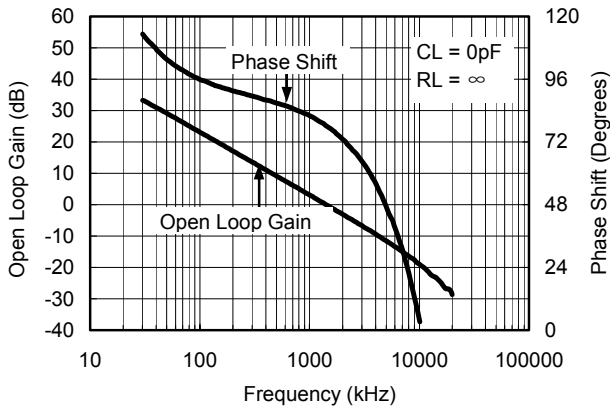

Open Loop Gain, Phase Shift vs. Frequency at +2.5V

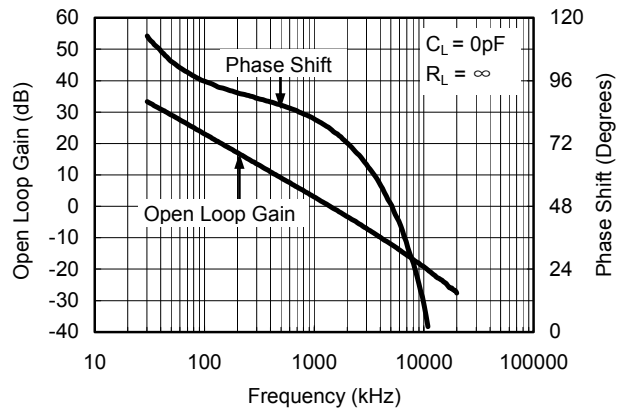

TYPICAL PERFORMANCE CHARACTERISTICS

Voltage Noise Density at +5V from 0.1Hz to 2.5kHz

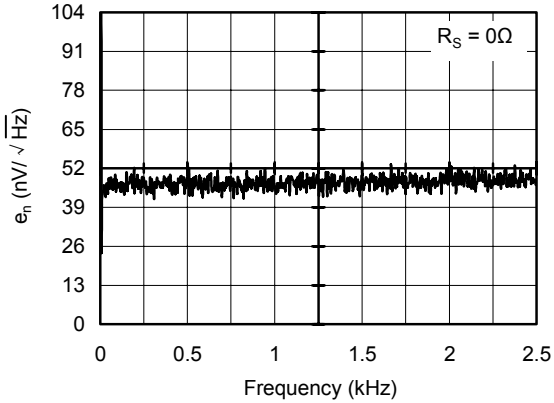

Voltage Noise Density at +2.5V from 0.1Hz to 2.5kHz

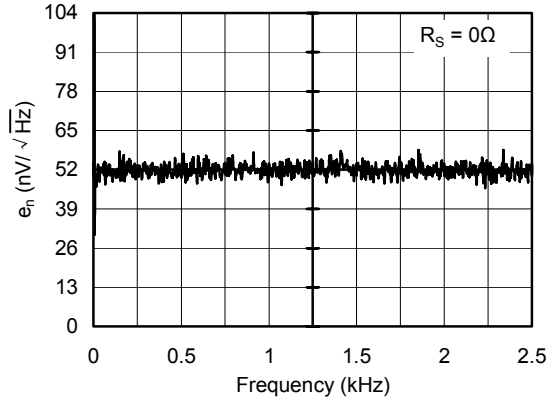

Voltage Noise Density at +5V from 0.1Hz to 25kHz

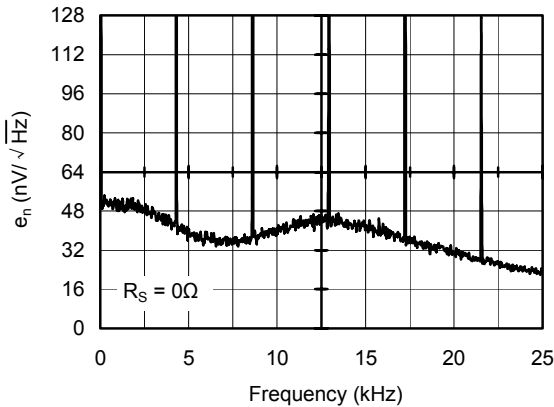

Voltage Noise Density at +2.5V from 0.1Hz to 25kHz

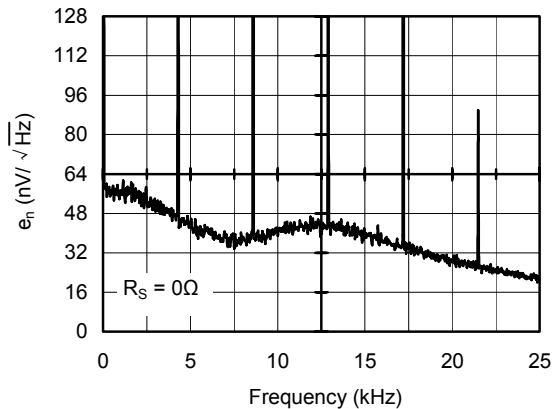

PSRR vs. Frequency at ±2.5V

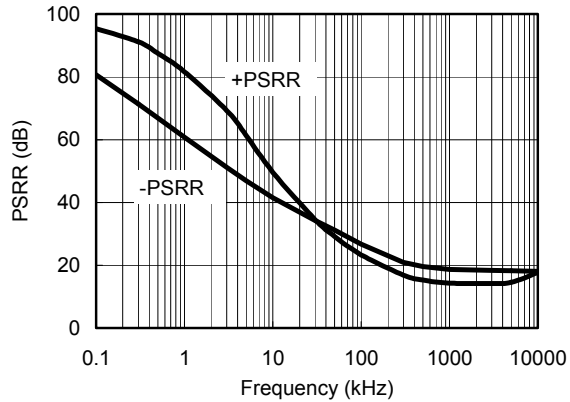

PSRR vs. Frequency at ±1.25V

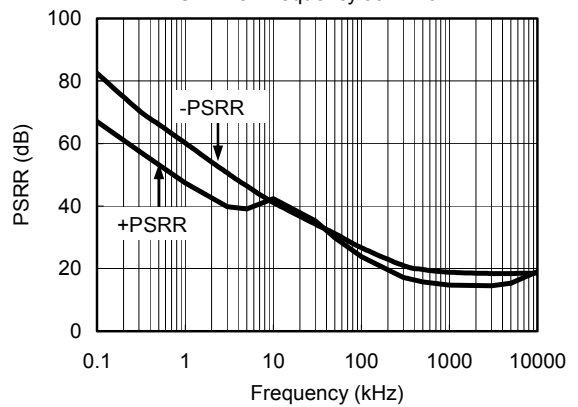

TYPICAL PERFORMANCE CHARACTERISTICS

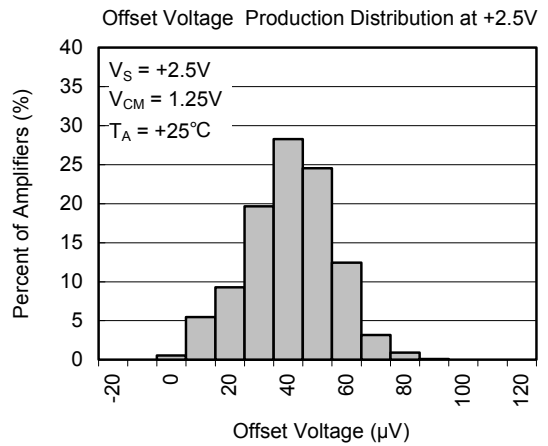
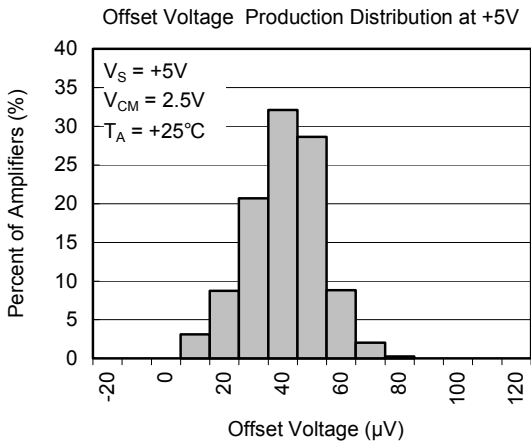
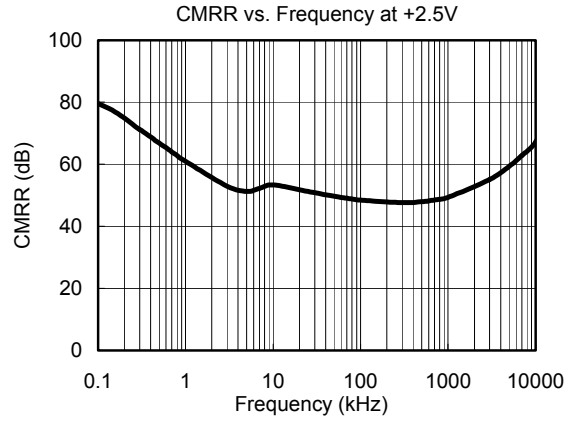
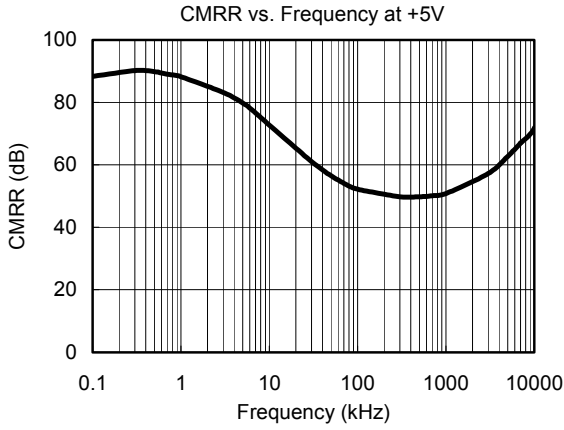

PACKAGE OUTLINE DIMENSIONS

SOT-23-5

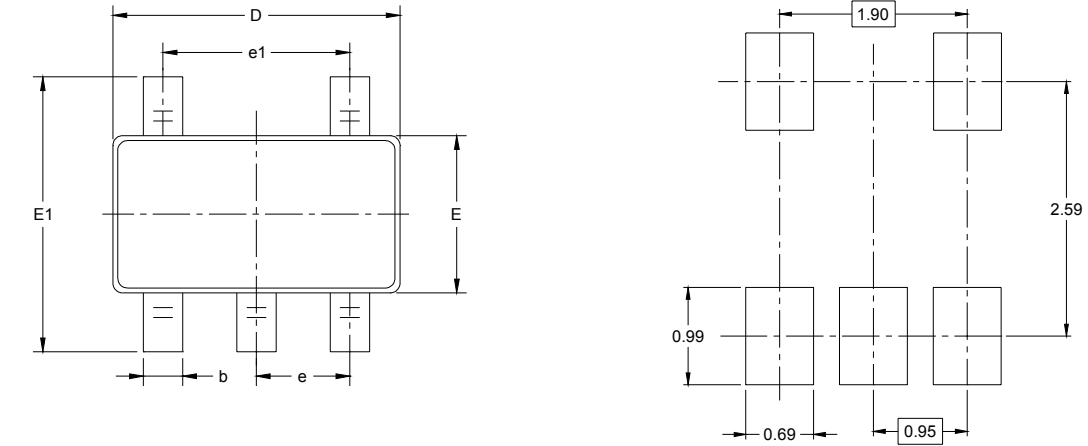

RECOMMENDED LAND PATTERN (Unit: mm)

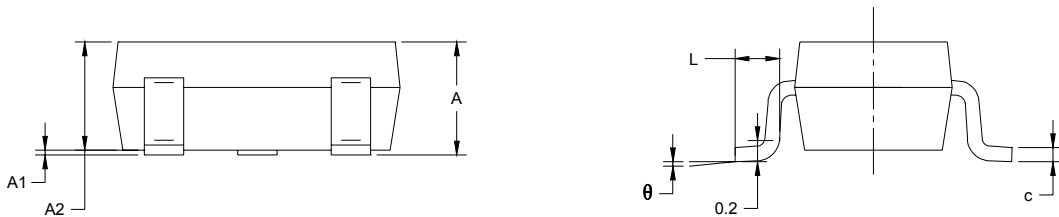

| Symbol | Dimensions In Millimeters | | Dimensions In Inches | |
|--------|------------------------------|-------|-------------------------|-------|
| | MIN | MAX | MIN | MAX |
| A | 1.050 | 1.250 | 0.041 | 0.049 |
| A1 | 0.000 | 0.100 | 0.000 | 0.004 |
| A2 | 1.050 | 1.150 | 0.041 | 0.045 |
| b | 0.300 | 0.500 | 0.012 | 0.020 |
| c | 0.100 | 0.200 | 0.004 | 0.008 |
| D | 2.820 | 3.020 | 0.111 | 0.119 |
| E | 1.500 | 1.700 | 0.059 | 0.067 |
| E1 | 2.650 | 2.950 | 0.104 | 0.116 |
| e | 0.950 BSC | | 0.037 BSC | |
| e1 | 1.900 BSC | | 0.075 BSC | |
| L | 0.300 | 0.600 | 0.012 | 0.024 |
| θ | 0° | 8° | 0° | 8° |

PACKAGE OUTLINE DIMENSIONS

SOIC-8

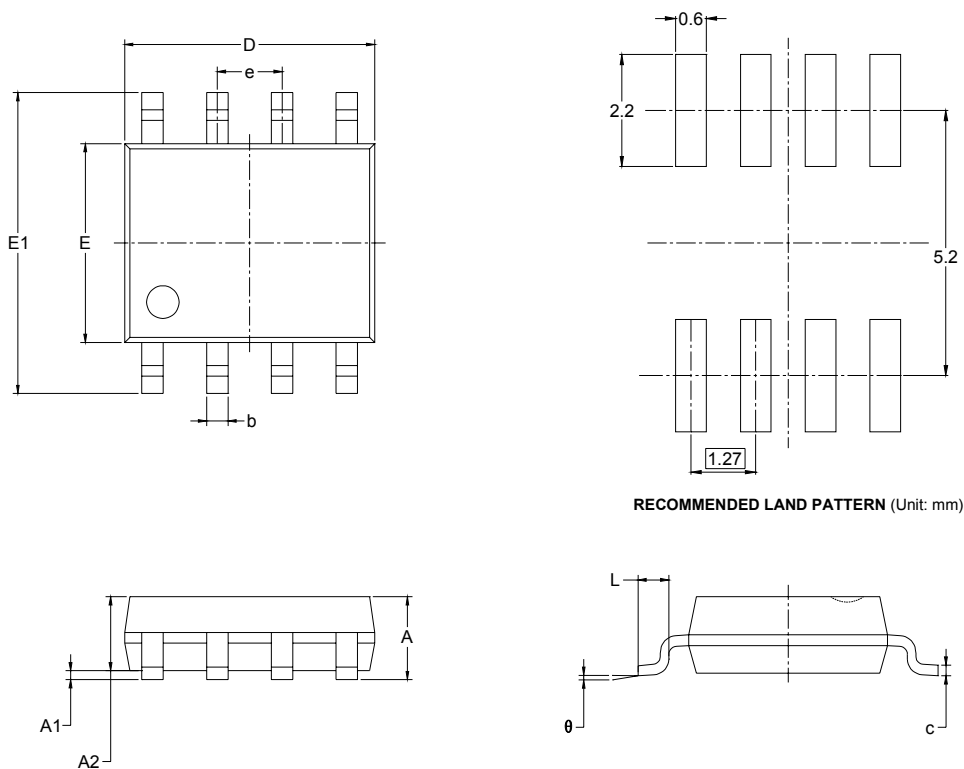

RECOMMENDED LAND PATTERN (Unit: mm)

| Symbol | Dimensions In Millimeters | | Dimensions In Inches | |
|----------|------------------------------|-------|-------------------------|-------|
| | MIN | MAX | MIN | MAX |
| A | 1.350 | 1.750 | 0.053 | 0.069 |
| A1 | 0.100 | 0.250 | 0.004 | 0.010 |
| A2 | 1.350 | 1.550 | 0.053 | 0.061 |
| b | 0.330 | 0.510 | 0.013 | 0.020 |
| c | 0.170 | 0.250 | 0.006 | 0.010 |
| D | 4.700 | 5.100 | 0.185 | 0.200 |
| E | 3.800 | 4.000 | 0.150 | 0.157 |
| E1 | 5.800 | 6.200 | 0.228 | 0.244 |
| e | 1.27 BSC | | 0.050 BSC | |
| L | 0.400 | 1.270 | 0.016 | 0.050 |
| θ | 0° | 8° | 0° | 8° |

PACKAGE OUTLINE DIMENSIONS

MSOP-8

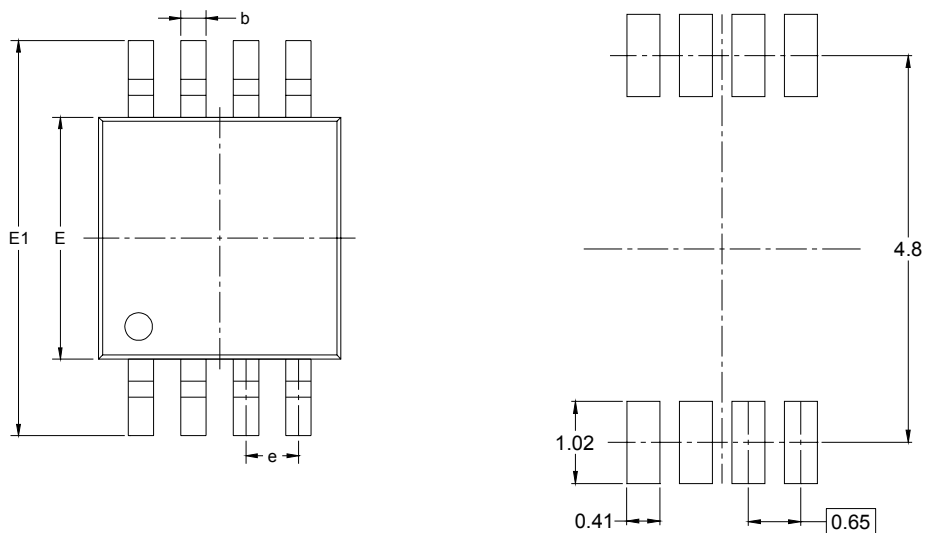

RECOMMENDED LAND PATTERN (Unit: mm)

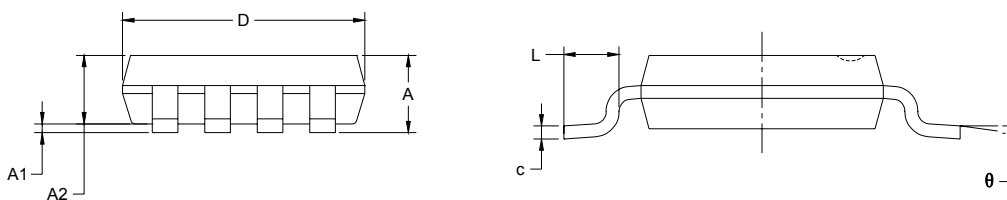

| Symbol | Dimensions In Millimeters | | Dimensions In Inches | |
|--------|------------------------------|-------|-------------------------|-------|
| | MIN | MAX | MIN | MAX |
| A | 0.820 | 1.100 | 0.032 | 0.043 |
| A1 | 0.020 | 0.150 | 0.001 | 0.006 |
| A2 | 0.750 | 0.950 | 0.030 | 0.037 |
| b | 0.250 | 0.380 | 0.010 | 0.015 |
| c | 0.090 | 0.230 | 0.004 | 0.009 |
| D | 2.900 | 3.100 | 0.114 | 0.122 |
| E | 2.900 | 3.100 | 0.114 | 0.122 |
| E1 | 4.750 | 5.050 | 0.187 | 0.199 |
| e | 0.650 BSC | | 0.026 BSC | |
| L | 0.400 | 0.800 | 0.016 | 0.031 |
| θ | 0° | 6° | 0° | 6° |