

General purpose PIN diode

FEATURES

- Low diode capacitance
- Low diode forward resistance.

APPLICATIONS

- General RF applications.

DESCRIPTION

General purpose PIN diode in a SOD323 small plastic SMD package.

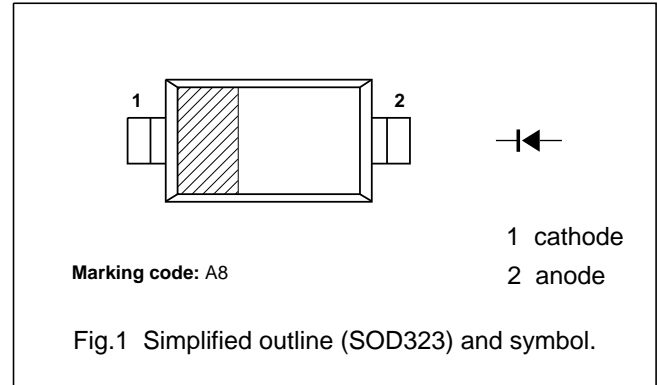

LIMITING VALUES

In accordance with the Absolute Maximum Rating System (IEC 134).

SYMBOL	PARAMETER	CONDITIONS	MIN.	MAX.	UNIT
V_R	continuous reverse voltage		–	50	V
I_F	continuous forward current		–	50	mA
P_{tot}	total power dissipation	$T_s = 90\text{ °C}$	–	500	mW
T_{stg}	storage temperature		–65	+150	°C
T_j	junction temperature		–65	+150	°C

ELECTRICAL CHARACTERISTICS

$T_j = 25\text{ °C}$ unless otherwise specified.

SYMBOL	PARAMETER	CONDITIONS	MIN.	TYP.	MAX.	UNIT
V_F	forward voltage	$I_F = 50\text{ mA}$	–	0.95	1.1	V
V_R	reverse voltage	$I_R = 10\text{ }\mu\text{A}$	50	–	–	V
I_R	reverse current	$V_R = 50\text{ V}$	–	–	100	nA
C_d	diode capacitance	$V_R = 0; f = 1\text{ MHz}$	–	0.4	–	pF
		$V_R = 1\text{ V}; f = 1\text{ MHz}$	–	0.3	0.55	pF
		$V_R = 5\text{ V}; f = 1\text{ MHz}$	–	0.2	0.35	pF
r_D	diode forward resistance	$I_F = 0.5\text{ mA}; f = 100\text{ MHz}; \text{note 1}$	–	25	40	Ω
		$I_F = 1\text{ mA}; f = 100\text{ MHz}; \text{note 1}$	–	14	25	Ω
		$I_F = 10\text{ mA}; f = 100\text{ MHz}; \text{note 1}$	–	3	5	Ω

Note

1. Guaranteed on AQL basis: inspection level S4, AQL 1.0.

THERMAL CHARACTERISTICS

SYMBOL	PARAMETER	VALUE	UNIT
$R_{th\ j-s}$	thermal resistance from junction to soldering point	85	K/W

GRAPHICAL DATA

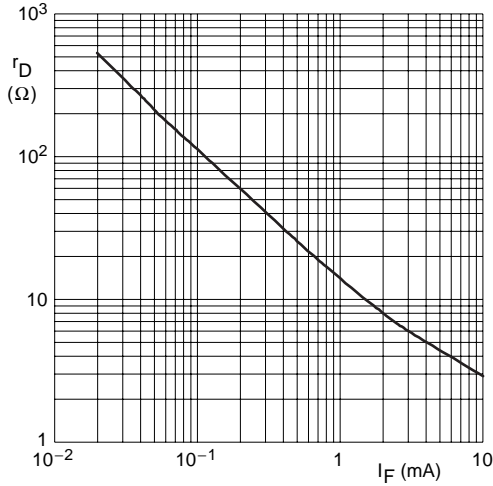

$f = 100 \text{ MHz}; T_j = 25 \text{ }^\circ\text{C}.$

Fig.2 Forward resistance as a function of forward current; typical values.

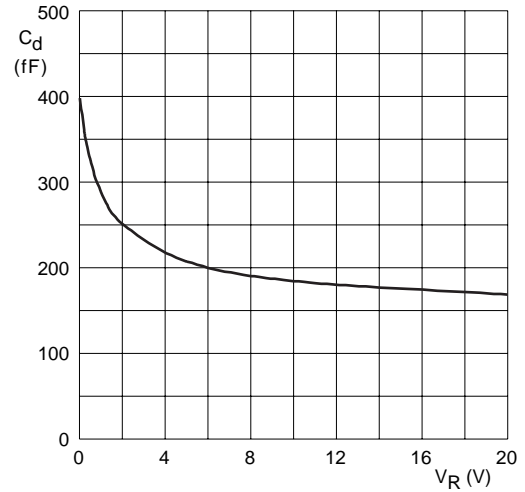

$f = 1 \text{ MHz}; T_j = 25 \text{ }^\circ\text{C}.$

Fig.3 Diode capacitance as a function of reverse voltage; typical values.

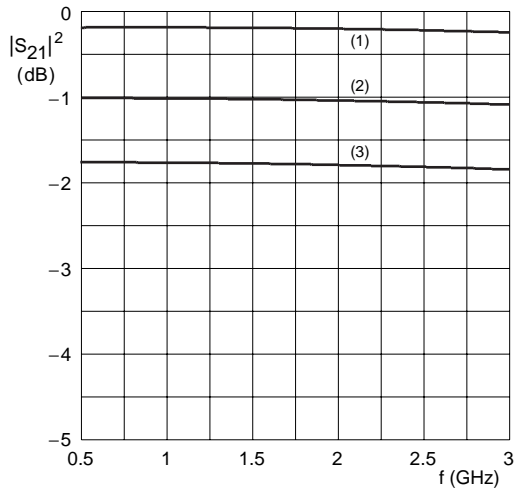

(1) $I_F = 10 \text{ mA}.$ (2) $I_F = 1 \text{ mA}.$ (3) $I_F = 0.5 \text{ mA}.$

Diode inserted in series with a $50 \text{ } \Omega$ stripline circuit and biased via the analyzer Tee network.

$T_{\text{amb}} = 25 \text{ }^\circ\text{C}.$

Fig.4 Insertion loss ($|S_{21}|^2$) of the diode as a function of frequency; typical values.

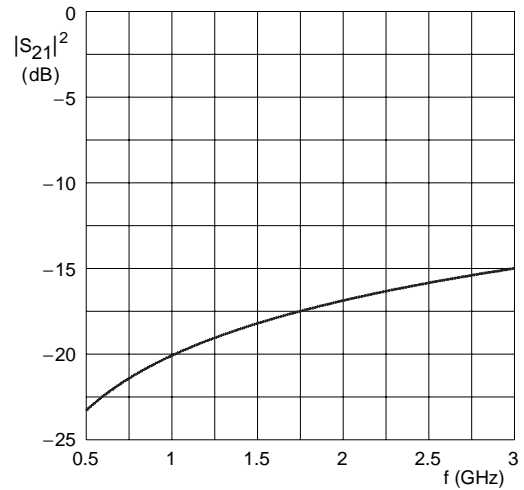

Diode zero biased and inserted in series with a $50 \text{ } \Omega$ stripline circuit.

$T_{\text{amb}} = 25 \text{ }^\circ\text{C}.$

Fig.5 Isolation ($|S_{21}|^2$) of the diode as a function of frequency; typical values.

PACKAGE OUTLINE

Plastic surface mounted package; 2 leads

SOD323

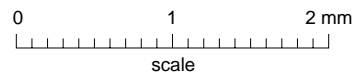
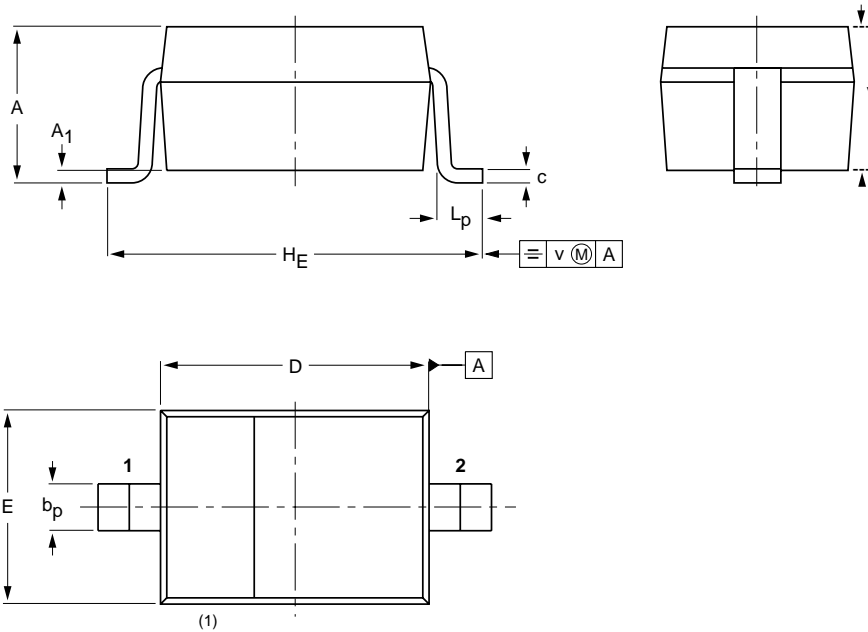

DIMENSIONS (mm are the original dimensions)

UNIT	A	A ₁	b _p	c	D	E	H _E	L _p	v	
mm	1.0	0.10	0.35	0.15	1.8	1.40	2.7	0.40	0.90	
	---	-0.00	0.25	0.08	1.6	1.20	2.5	0.25	0.80	

Note

1. The marking bar indicates the cathode.