



# SPECIFICATION FOR APPROVAL

CN: 0

CUSTOMER : \_\_\_\_\_

PRODUCT TYPE : SMD SEAM SEALING X'TAL 3.2x2.5

NOMINAL FREQ. : 10.000000MHz

TXC P/N : AM10000301

REVISION : A1

CUSTOMER P/N : \_\_\_\_\_

PM / SALES : \_\_\_\_\_

DATE : \_\_\_\_\_

CUSTOMER CONFIRMATION : \_\_\_\_\_  
 (Singnature)

\_\_\_\_\_ (Date)

- (1) TXC requires one copy returned with signature and title of authorized individual that signifies acceptance of the attached specifications.
- (2) Orders received and accepted by TXC after return of signed copy of specification will be produced per these specifications.
- (3) Any changes to these specifications must be agreed upon by both parties and new revision of the Product Specification Sheet will be issued.
- (4) Any issuance of purchase order prior to consigning back the Approval page of "Specification Sheets" from customers will be regarded as the agreement on the contents of these specifications.

**MSL:Level 1  
RoHS Compliant**

(for glass crystal only : Pb used with sealing glass material is exempt from EU directive)



# PRODUCT SPECIFICATION SHEET

CN: \_\_\_\_\_

PRODUCT TYPE : SMD SEAM SEALING X'TAL 3.2x2.5

---

NOMINAL FREQ. : 10.000000MHz

---

TXC P/N : AM10000301

---

REVISION : A1

---

PE/RD	QA	MFG
<i>Wen yuan Chang</i>	<i>ZhongLin Wu</i>	<i>Zhi Jun Wu</i>
Wen yuan Chang	ZhongLin Wu	Zhi jun Wu
<i>6-Dec-17</i>	<i>6-Dec-17</i>	<i>6-Dec-17</i>

NOTE:

- (1) TXC green product standard is based on the international standards. Relevant information is posted on the TXC website and updated regularly. The documentation is subject to the latest green product quality system.
- (2) Revision "Sx" is for engineering samples only. PE/RD's approval required.
- (3) Revision "Ax" is production ready. PE, QA and MFG's approval required.

**MSL:Level 1**  
**RoHS Compliant**

(for glass crystal only : Pb used with sealing glass material is exempt from EU directive)



<u>Rev</u>	<u>Revise page</u>	<u>Revise contents</u>	<u>Date</u>	<u>Ref.No.</u>	<u>Reviser</u>
S1	N/A	Initial released	5-Sep-16	N/A	Xiaohua Zhang
A1	N/A	S Turn A	6-Dec-17	N/A	Xiaohua Zhang



## Spec Sheet Contents

No.	Content	Page
1	ELECTRICAL SPECIFICATIONS	P.3
2	DIMENSIONS	P.4
3	MARKING	P.4
4	FACTORY LOCATION	P.4
5	SUGGESTED REFLOW PROFILE & MANUAL SOLDER CONDITION	P.4
6	STRUCTURE ILLUSTRATION	P.5
7	EMBOSS CARRIER TAPE & REEL	P.6
8	PACKING	P.7
9	RELIABILITY SPECIFICATIONS	P.8

**ELECTRICAL SPECIFICATIONS****Standard conditions**

Ambient temperature : 25±5°C

Relative humidity : 40%~70%

In addition to special specifications, are measured in the standard environment.

Ambient temperature : 25±3°C

Relative humidity : 40%~70%

If there is any doubt about the result, it is necessary to make measurements in the standard environment.

**Measure equipment**

Electrical characteristics measured by S&amp;A 250B or equivalent.

**Crystal cutting type**

The crystal is using AT CUT (thickness shear mode).

**Unit Weight:**

0.018±0.001 g/pcs

	Parameters	SYM.	Electrical Spec.				Notes
			MIN	TYPE	MAX	UNITS	
1	Nominal Frequency	FL	10.000000			MHz	-
2	Oscillation Mode	-	Fundamental			-	-
3	Load Capacitance	CL	8			pF	-
4	Frequency Tolerance	-	±15			ppm	at 25 °C ± 3 °C
5	Frequency Stability	-	±50			ppm	Over Operating Temp. Range (Reference 25°C)
6	Operating Temperature	-	-40	~	125	°C	-
7	Aging	-	±3			ppm	1st Year at 25 °C ± 3 °C
8	Drive Level	DL	-	10	100	μW	-
9	Effective Resistance Rr	Rr	-	-	200	Ω	-
10	Shunt Capacitance C0	C0	-	-	2	pF	-
11	Insulation Resistance	-	500	-	-	MΩ	at DC 100V
12	Storage Temperature Range	-	-40	~	125	°C	-

**■ DIMENSIONS**

(Unit:mm)

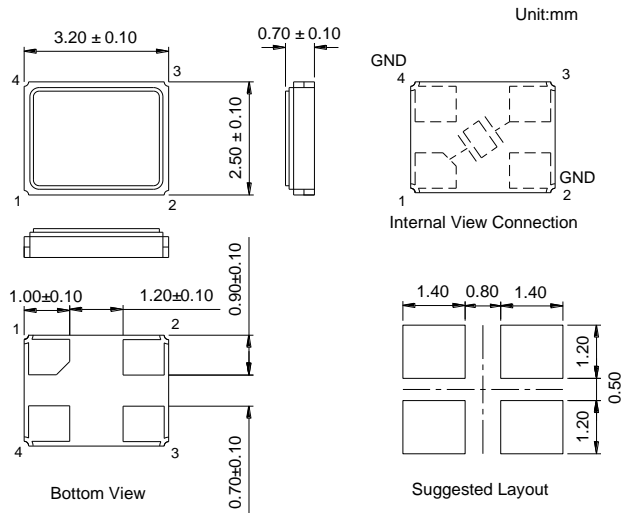

**■ MARKING**

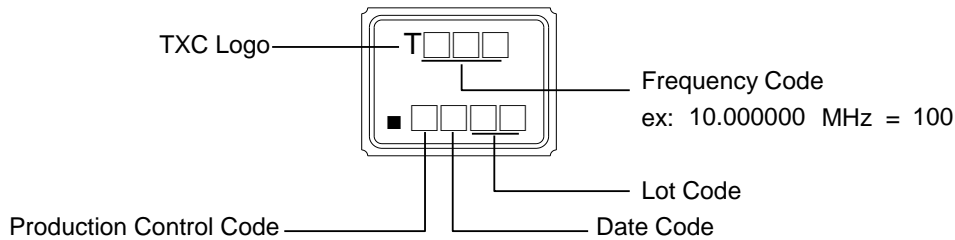

**Month Code:**

YEAR					MONTH											
					JAN	FEB	MAR	APR	MAY	JUN	JUL	AUG	SEP	OCT	NOV	DEC
2005	2009	2013	2017	2021	A	B	C	D	E	F	G	H	J	K	L	M
2006	2010	2014	2018	2022	N	P	Q	R	S	T	U	V	W	X	Y	Z
2007	2011	2015	2019	2023	a	b	c	d	e	f	g	h	j	k	l	m
2008	2012	2016	2020	2024	n	p	q	r	s	t	u	v	w	x	y	z

\*This month code will be cycled every four years

**Production location: Taiwan & China (NGB)**

**■ SUGGESTED REFLOW PROFILE**

Peak Temperature : 260±5°C, 10 sec. Max.  
Solder melting point : 220±10 °C, 60 sec. Min.

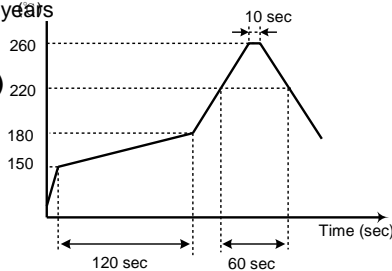

**■ SUGGESTED MANUAL SOLDER CONDITION**

Temperature: 350 ± 10 °C  
Time: 3 sec.  
Re-solder times: twice

NOTE: After manual welding, the product shall be measured down to room temperature.

■ STRUCTURE ILLUSTRATION

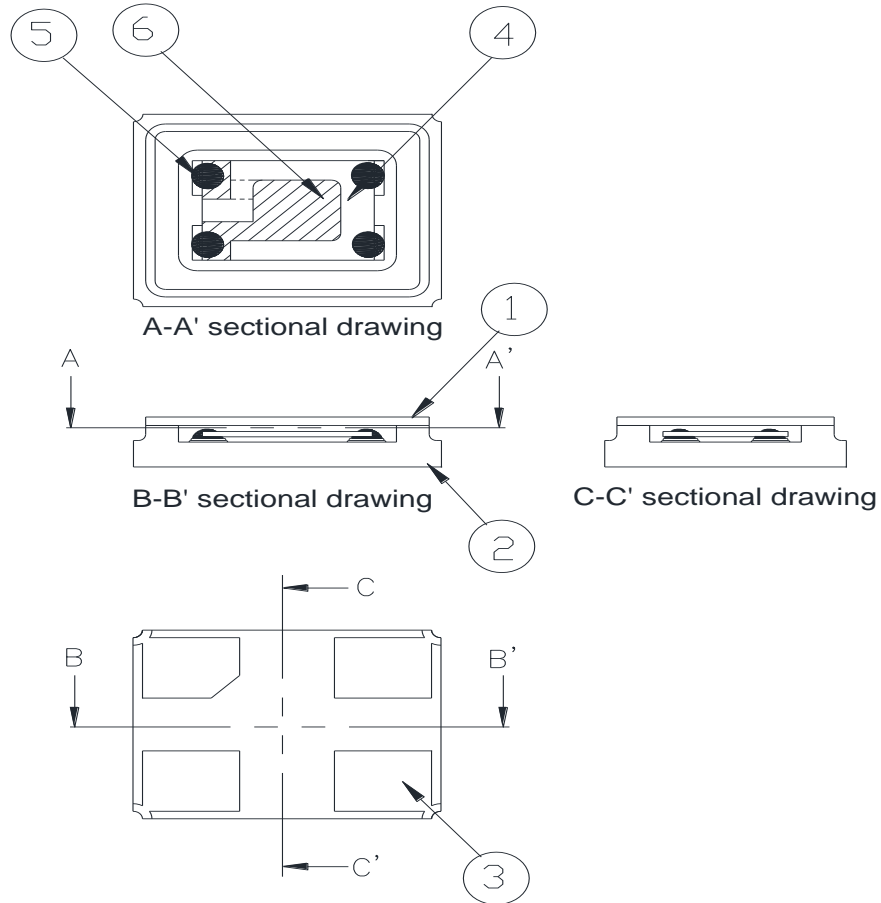

NO	COMPONENTS	MATERIALS	FINISH/SPECIFICATIONS
1	Lid	Kovar (Fe/Co/Ni)	-
2	Base(Package)	Ceramic (Al <sub>2</sub> O <sub>3</sub> ) + Kovar (Fe/Co/Ni)+ Ag/Cu	Color black
3	PAD	Au	Tungsten metalize + Ni plating + Au plating
4	Crystal blank	SiO <sub>2</sub>	-
5	Conductive adhesive	Ag	Silicon resin
6	Electrode	Noble Metal	-

■ PACKING

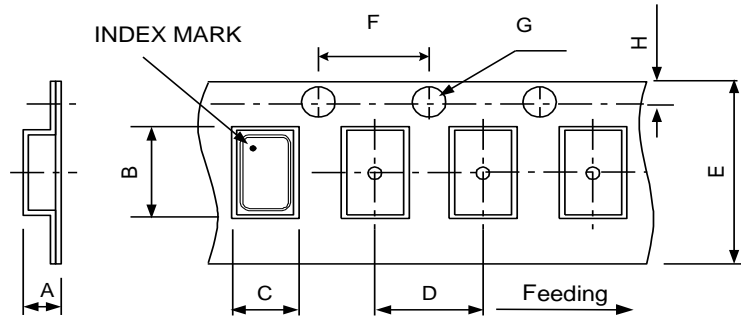

DIMENSIONS	A	B	C	D	E	F	G	H	(UNIT : mm)
	1.65	3.40	2.70	4.00	8.00	4.00	1.50	1.75	

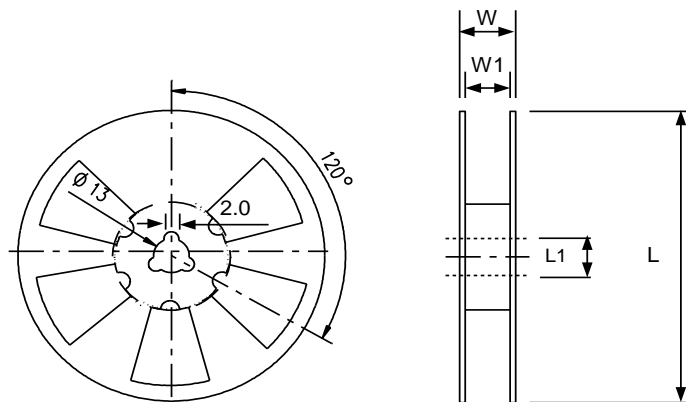
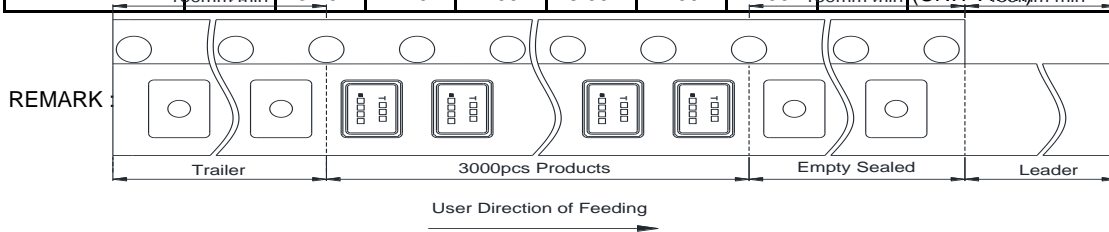

DIMENSIONS	L	L1	W	W1	pcs / Reel (UNIT : mm)
	178.0	13.0	11.5	8.0	Standard Reel Quantity is 3,000 pcs per reel



■PACKING

Box Item:

- 1. Reel X 6 (L200 X W200 X H140mm)
- 2. Reel X 12 (L200 X W200 X H250mm)
- 3. Reel X 25 (L400 X W400 X H280mm)
- 4. Reel X 50 (L400 X W400 X H280mm)
- 5. Reel X 100 (L399 X W346 X H360mm)

Note:

- 1. For the maximum reel of loads for each type box.
- 2. The number of reels is slightly adjusted according to each factory.

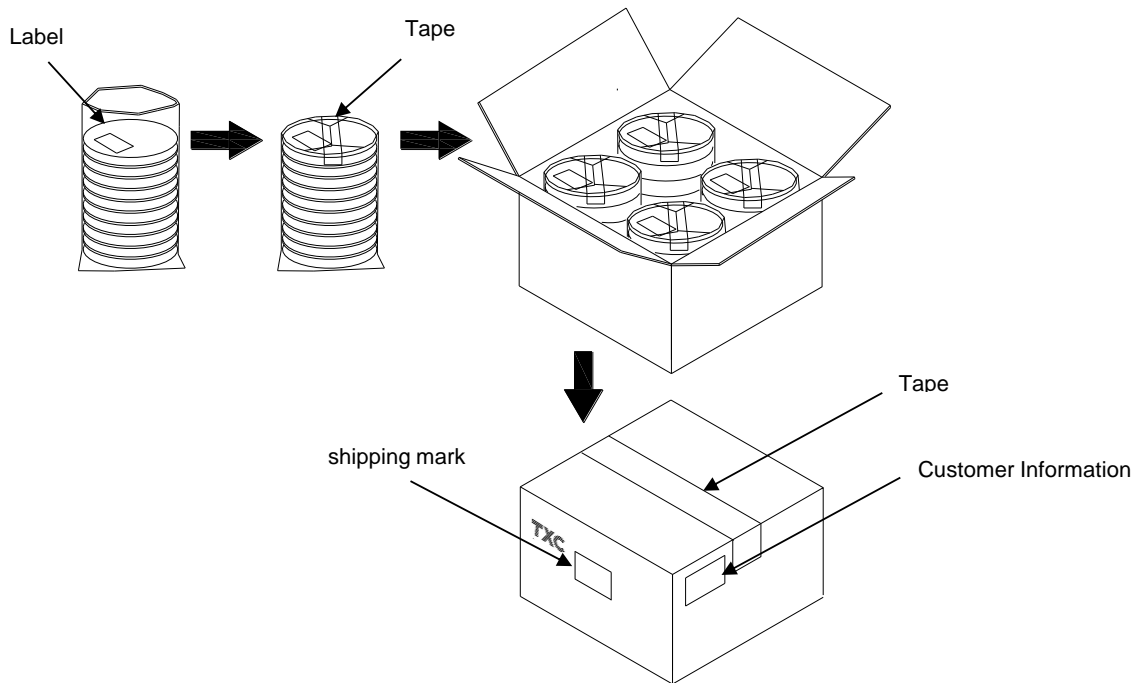

Label :

<b>TXC CORPORATION</b>		<b>QA PASS</b>
DATE CODE:	Q' TY:	<input type="text"/>
LOT NO:		
PART NO:	<b>RoHS</b>	
FREQ: <input type="text"/>	<b>HF</b>	

**[STORAGE]**

- 1. Do not get wet by the rain.
- 2. The storage environment shall be 5°C ~40°C and 30% ~ 75%RH humidity and avoid exposure to sunlight.
- 3. If customers have special requirements, we can coordinate.

**RELIABILITY SPECIFICATIONS (AEC-Q200 Compliant)**
**1. Mechanical Endurance**

No.	Test Item	Test Methods	REF.DOC
1.1	Drop Test	120 cm height, 10 times on Stainless Plate .	JIS C 6701
1.2	Mechanical Shock	Device are shocked to half sine wave ( 3000 G ) three mutually perpendicular axes each 3 times. 0.3m sec. duration time	MIL-STD-202 Method 213
1.3	Vibration	Frequency range                      10 ~ 2000 Hz~10 Hz Amplitude                                      1.52 mm/10G Sweep time                                      20 minute Perpendicular axes each test time      4 Hrs (Total test time 12 Hrs)	MIL-STD-202 Method 204
1.4	Solderability	Temperature                                  245 °C ± 5°C Immersing depth                              1.25 mm Immersion time                                5 ± 1 seconds Flux    Rosin resin methyl alcohol solvent ( 1 : 4 )	J-STD-002
1.5	Terminal Strength	Mount on PCB board and shear strength 1.8kg for 60 sec.	AEC-Q200-006
1.6	Board Flex	Duration Time: 60 sec, Deviation: 3mm	AEC-Q200-005

**2. Environmental Endurance**

No.	Test Item	Test Methods	REF. DOC
2.1	Resistance To Soldering Heat	Pre-heat temperature                      125 °C Pre-heat time                                      60 ~ 120 sec. Test temperature                                260 ± 5 °C Test time    10 ± 1 sec.	MIL-STD 202 Method 210
2.2	High Temp. Storage	+ 125 °C ± 3 °C for all 1000 Hrs.	MIL-STD-202 Method 108
2.3	Low Temp. Storage	- 40 °C ± 3 °C for all 1000 Hrs.	JIS C 6701
2.4	Thermal Shock	Total 1000 cycles of the following Thermal Shock : 	MIL-STD-202 Method 107
2.5	Temperature Cycle	Total 1000 cycles of the following temperature cycle : - 40°C ± 3 to 125°C ± 3 , Dwell time:15min.	JESD 22 Method JA-104
2.6	Biased Humidity	+ 85°C ± 3°C , RH 85% , 1000 Hrs.	MIL-STD-202 Method 103
2.7	Moisture Resistance	20 cycles ( +25°C~65°C , 80%~100% RH ) , 24hrs/cycle.	MIL-STD 202 Method 106
2.8	Operational Life	+ 85 °C ± 3 °C for 1000 Hrs.	MIL-STD-202 Method 108