

## ● FEATURES

- Low turn-on voltage.
- Fast switching.
- Ultra-small surface mount package.
- PN junction guard ring for transient and ESD protection.

## ● APPLICATIONS

- Schottky barrier detector and switching diodes.

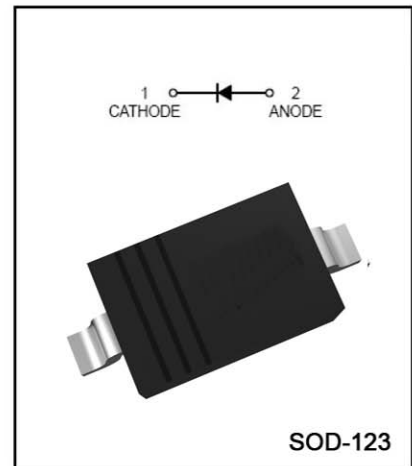

## ● MAXIMUM RATING @ Ta=25°C unless otherwise specified

Parameter	Symbol	Limits	Unit
Non-Repetitive Peak reverse voltage	$V_{RM}$	30	V
DC Reverse Voltage	$V_R$	21	V
Average Rectified Output Current	$I_O$	100	mA
Forward continuous Current	$I_F$	200	mA
Repetitive peak Forward Current	$I_{FRM}$	300	mA
Forward Surge Current	$I_{FSM}$	600	mA
Power Dissipation	$P_d$	200	mW
Thermal resistance, junction to ambient air	$R_{\theta JA}$	625	°C/W
Junction temperature	$T_j$	125	°C
Storage temperature range	$T_{stg}$	-65-150	°C

● ELECTRICAL CHARACTERISTICS @ Ta=25°C unless otherwise specified

Parameter	Symbol	Conditions	Min.	Typ.	Max.	Unit
Reverse Breakdown Voltage	$V_{(BR)R}$	$I_R=100\mu A$	30			V
Forward voltage	$V_{F1}$	$I_F=0.1mA$			240	mV
	$V_{F2}$	$I_F=1.0mA$			320	mV
	$V_{F3}$	$I_F=10mA$			400	mV
	$V_{F4}$	$I_F=30mA$			500	mV
	$V_{F5}$	$I_F=100mA$			1000	mV
Reverse current	$I_R$	$V_R=25v$			2.0	$\mu A$
Reverse recovery time	$t_{rr}$	$I_F=10mA, I_R=10mA$ to $1mA, R_L=100\Omega$			5.0	ns
Capacitance between terminals	$C_T$	$V_R=0, f=1MHz$			10	pF

TYPICAL CHARACTERISTICS @ Ta=25°C unless otherwise specified

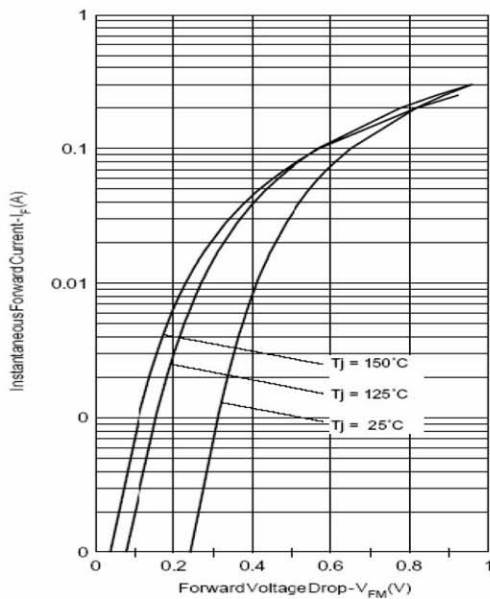

Fig. 1 - Max. Forward Voltage Drop Characteristics (Per Leg)

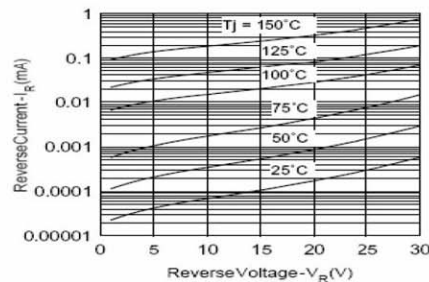

Fig. 2 - Typical Values Of Reverse Current Vs. Reverse Voltage (Per Leg)

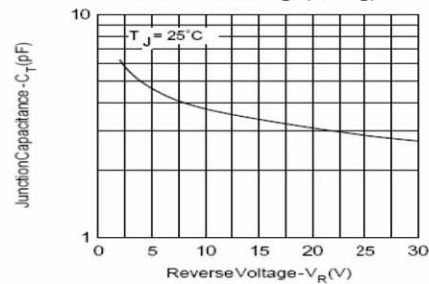

Fig. 3 - Typical Junction Capacitance Vs. Reverse Voltage (Per Leg)

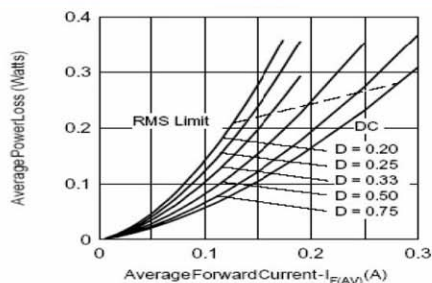

Fig. 4 - Forward Power Loss Characteristics

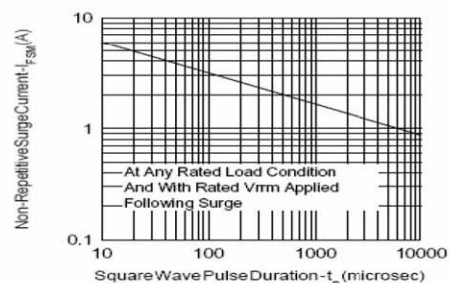
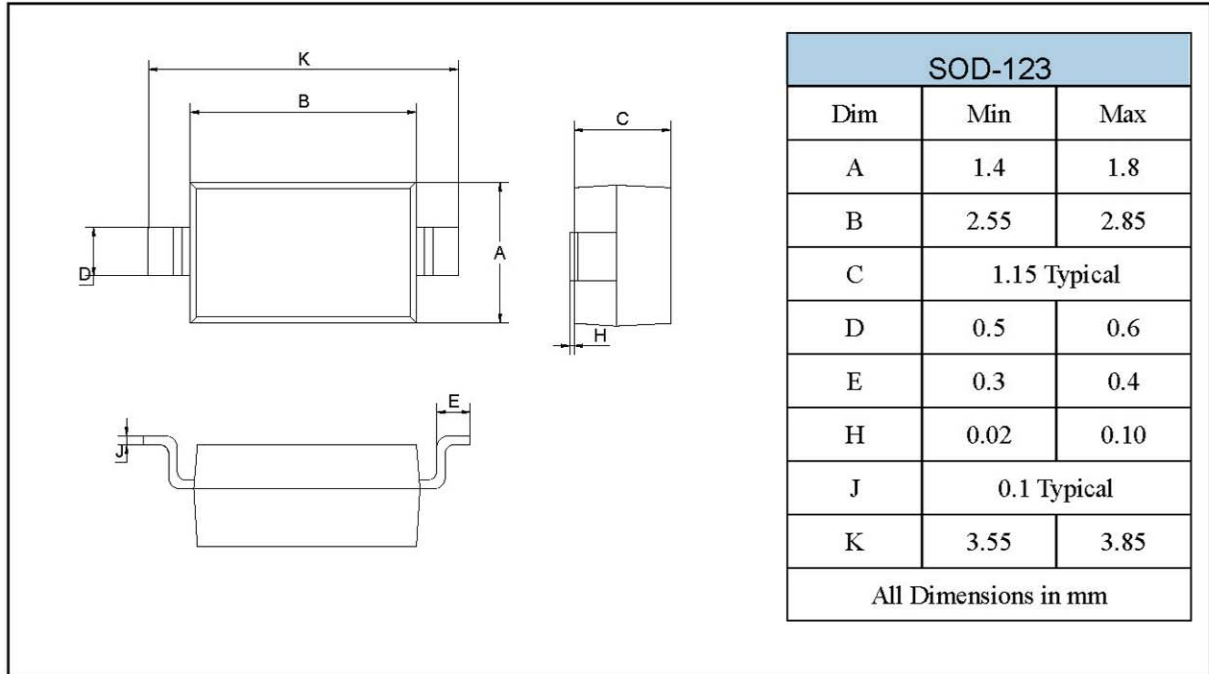

Fig. 5 - Max. Non-Repetitive Surge Current

## PACKAGE OUTLINE

Plastic surface mounted package



## SOLDERING FOOTPRINT

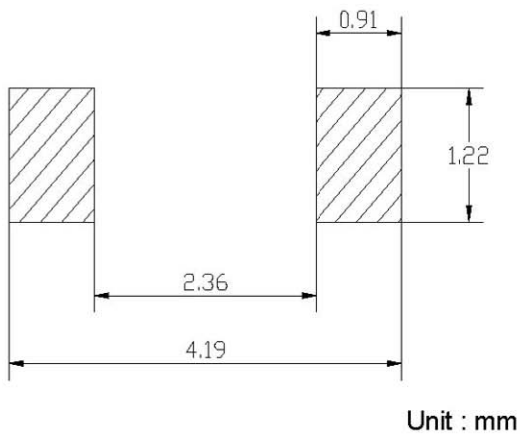

## PACKAGE INFORMATION

Device	Package	Shipping
BAT54T	SOD-123	3000/Tape&Reel