

SPTECH Product Specification

SPTECH Silicon PNP Power Transistor

MJW0302A

DESCRIPTION

- High DC current amplifier rate
 $h_{FE}: 50-200 @ V_{CE} = 5V, I_C = 1A$
- Minimum Lot-to-Lot variations for robust device performance and reliable operation

APPLICATIONS

- High power audio, disk head positioners and other linear applications.

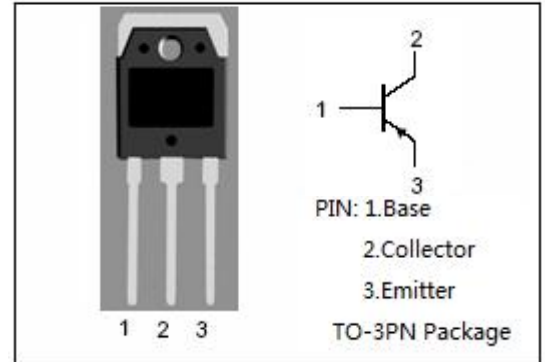

ABSOLUTE MAXIMUM RATINGS($T_a=25^{\circ}C$)

SYMBOL	PARAMETER	VALUE	UNIT
V_{CBO}	Collector-Base Voltage	-250	V
V_{CEO}	Collector-Emitter Voltage	-250	V
V_{CEX}	Collector-Emitter Voltage $V_{EB} = 5V$	-250	V
V_{EBO}	Emitter-Base Voltage	-5	V
I_C	Collector Current-Continuous	-15	A
I_{CM}	Collector Current-Peak	-30	A
I_B	Base Current-Continuous	-1.5	A
P_T	Total Power Dissipation @ $T_C=25^{\circ}C$	150	W
T_J	Junction Temperature	150	$^{\circ}C$
T_{stg}	Storage Temperature Range	-65~150	$^{\circ}C$

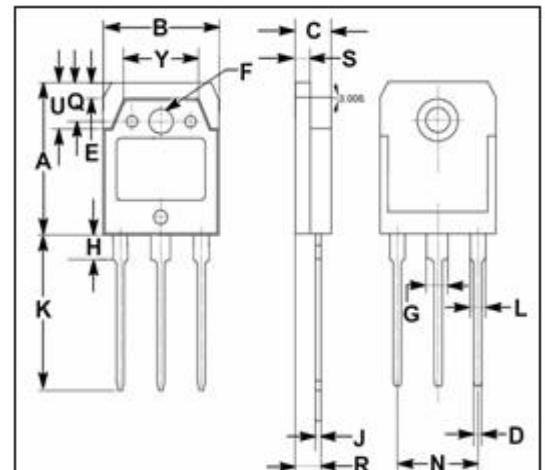

DIM	mm	
	MIN	MAX
A	19.60	20.30
B	15.50	15.70
C	4.70	4.90
D	0.90	1.10
E	1.90	2.10
F	3.40	3.60
G	2.90	3.20
H	3.20	3.40
J	0.595	0.605
K	19.80	20.70
L	1.90	2.20
N	10.89	10.91
Q	4.90	5.10
R	3.35	3.45
S	1.995	2.100
U	5.90	6.20
Y	9.90	10.10

THERMAL CHARACTERISTICS

SYMBOL	PARAMETER	MAX	UNIT
$R_{th(j-c)}$	Thermal Resistance, Junction to Case	0.63	$^{\circ}C/W$

SPTECH Product Specification

SPTECH Silicon PNP Power Transistor

MJW0302A

ELECTRICAL CHARACTERISTICS

$T_C=25^\circ\text{C}$ unless otherwise specified

SYMBOL	PARAMETER	CONDITIONS	MIN	TYP.	MAX	UNIT
$V_{CEO(SUS)}$	Collector-Emitter Sustaining Voltage	$I_C=-100\text{mA}; I_B=0$	-250			V
$V_{CE(sat)}$	Collector-Emitter Saturation Voltage	$I_C=-10\text{A}; I_B=-1\text{A}$			-0.6	V
$V_{BE(on)}$	Base-Emitter On Voltage	$I_C=-8\text{A}; V_{CE}=-5\text{V}$			-1.5	V
I_{CBO}	Collector Cutoff Current	$V_{CB}=-250\text{V}$			-50	mA
I_{CEO}	Collector Cutoff Current	$V_{CE}=-250\text{V}$			-50	mA
I_{EBO}	Emitter Cutoff Current	$V_{EB}=-5\text{V}$			-5	mA
h_{FE-1}	DC Current Gain	$I_C=-0.1\text{A}; V_{CE}=-5\text{V}$	75		150	
h_{FE-2}	DC Current Gain	$I_C=-1\text{A}; V_{CE}=-5\text{V}$	75		150	
h_{FE-3}	DC Current Gain	$I_C=-3\text{A}; V_{CE}=-5\text{V}$	75		150	
h_{FE-4}	DC Current Gain	$I_C=-5\text{A}; V_{CE}=-5\text{V}$	45			
h_{FE-5}	DC Current Gain	$I_C=-8\text{A}; V_{CE}=-5\text{V}$	15			