

SPTECH Product Specification

SPTECH Silicon NPN Power Transistor

MJW0281A

DESCRIPTION

- High DC current amplifier rate
 $h_{FE}: 50-200 @ V_{CE} = 5V, I_C = 1A$
- Minimum Lot-to-Lot variations for robust device performance and reliable operation

APPLICATIONS

- High power audio, disk head positioners and other linear applications.

ABSOLUTE MAXIMUM RATINGS ($T_a = 25^\circ C$)

SYMBOL	PARAMETER	VALUE	UNIT
V_{CBO}	Collector-Base Voltage	250	V
V_{CEO}	Collector-Emitter Voltage	250	V
V_{EBO}	Emitter-Base Voltage	5	V
I_C	Collector Current-Continuous	15	A
I_{CP}	Collector Current-Pulse	30	A
I_B	Base Current-Continuous	1.5	A
P_C	Total Power Dissipation @ $T_C = 25^\circ C$	150	W
T_J	Junction Temperature	150	$^\circ C$
T_{stg}	Storage Temperature Range	-65~150	$^\circ C$

THERMAL CHARACTERISTICS

SYMBOL	PARAMETER	MAX	UNIT
R_{thj-c}	Thermal Resistance, Junction to Case	0.63	$^\circ C/W$

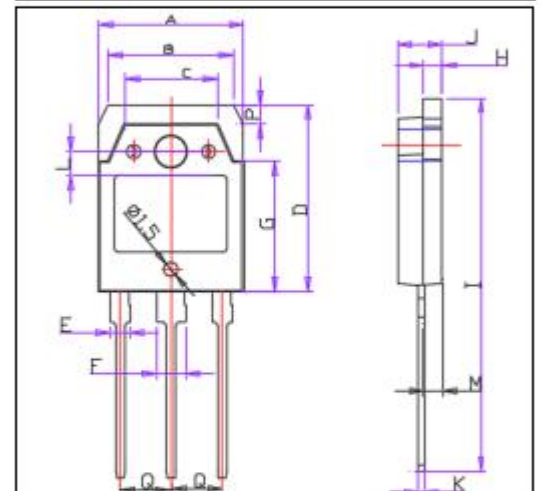
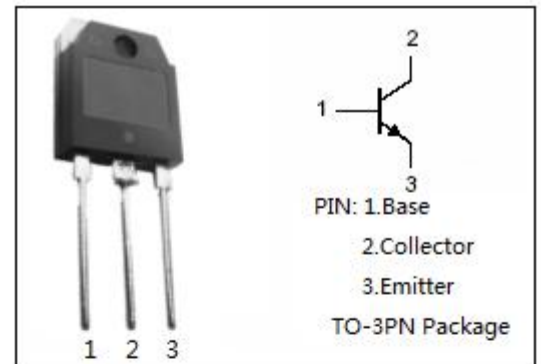

DIM	mm	
	MIN	MAX
A	15.45	15.75
B	13.45	13.75
C	9.45	9.75
D	19.80	20.20
E	2.00	2.20
F	2.95	3.25
G	13.70	14.10
H	1.40	1.60
I	18.45	18.75
J	4.70	4.90
K	0.50	0.70
L	2.20	2.60
M	1.20	1.60
P	1.80	2.20
Q	5.25	5.65

SPTECH Product Specification

SPTECH Silicon NPN Power Transistor

MJW0281A

ELECTRICAL CHARACTERISTICS

$T_c=25^{\circ}\text{C}$ unless otherwise specified

SYMBOL	PARAMETER	CONDITIONS	MIN	MAX	UNIT
$V_{CEO(SUS)}$	Collector-Emitter Sustaining Voltage	$I_C=100\text{mA}$; $I_B=0$	250		V
$V_{CE(sat)}$	Collector-Emitter Saturation Voltage	$I_C= 10\text{A}$; $I_B= 1\text{A}$		2	V
$V_{BE(on)}$	Base-Emitter Saturation Voltage	$I_C= 8\text{A}$; $V_{CE}= 5\text{V}$		2	V
I_{CBO}	Collector Cutoff Current	$V_{CB}= 250\text{V}$; $I_E=0$		50	μA
I_{EBO}	Emitter Cutoff Current	$V_{EB}= 5\text{V}$; $I_C=0$		5	μA
h_{FE-1}	DC Current Gain	$I_C= 100\text{mA}$; $V_{CE}= 5\text{V}$	75	150	
h_{FE-2}	DC Current Gain	$I_C= 1\text{A}$; $V_{CE}= 5\text{V}$	75	150	
h_{FE-3}	DC Current Gain	$I_C= 8\text{A}$; $V_{CE}= 5\text{V}$	75		
h_{FE-4}	DC Current Gain	$I_C= 15\text{A}$; $V_{CE}= 5\text{V}$	12		