

WL2851E

High Input Voltage, Low Quiescent Current LDO

Descriptions

The WL2851E series is a high accuracy, high input voltage low quiescent current, high speed, and low dropout Linear regulator with high ripple rejection. The device is manufactured with Bi-CMOS process.

The WL2851E offers over-current limit and over temperature protection to ensure the device working in well conditions.

The WL2851E regulators are available in standard SOT-23-5L packages. Standard products are Pb-free and Halogen-free.

Features

- Supply Voltage : 4.75V~40V
- Output Range : 1.8V~5.7V
- Output Accuracy : <+/-2%
- Output Current : 150mA @ (V_{IN}-V_{OUT}=2V)(Typ.)
- PSRR : 60dB @ 100Hz
- Dropout Voltage : 240mV @ I_{OUT}=30mA
- Quiescent Current : 10μA@V_{IN}=7V(Typ.)
- Recommend Capacitor : 10uF

[Http://www.sh-willsemi.com](http://www.sh-willsemi.com)



SOT-23-5L

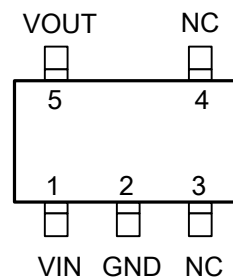

Pin Configuration (Top View)

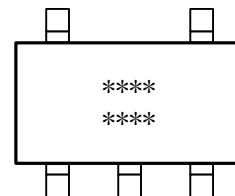

For detail marking information, please see page 8.

Marking

Order Information

For detail order information, please see page 8.

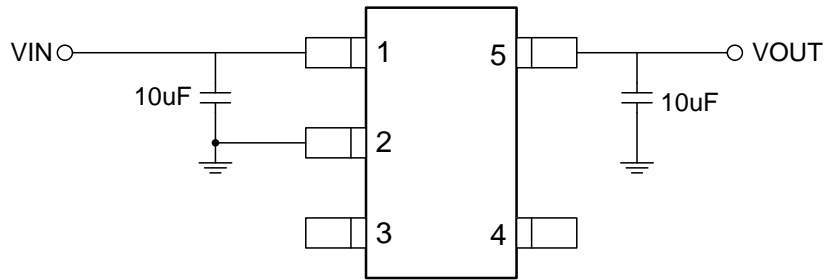
Typical Application

(Locate Cin and Cout as close to the Vin pin and Vout pin as possible.)

Pin Description

PIN	Symbol	Description
1	VIN	Voltage Input
2	GND	Ground
3	NC	Not Connect
4	NC	Not Connect
5	VOUT	Voltage Output

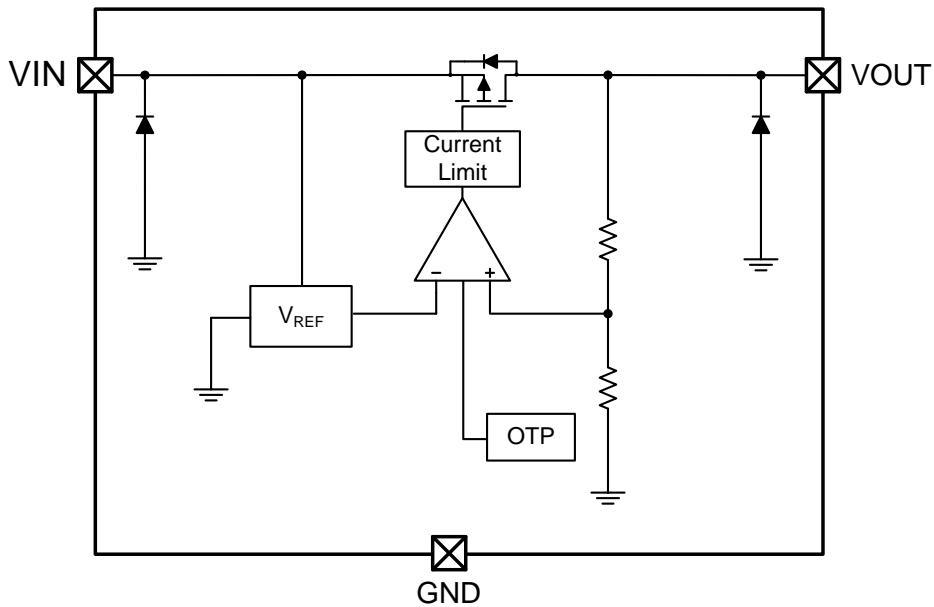
Block Diagram

Absolute Maximum Ratings

Parameter	Value	Unit
Power Dissipation	Internal limited	mW
V _{IN} Range	-0.3~45	V
V _{OUT} Range	-0.3~6.5	V
Lead Temperature Range	260	°C
Storage Temperature Range	-55 ~ 150	°C
Operating Junction Temperature Range	150	°C
ESD MM	400	V
ESD HBM	4K	V

Recommend Operating Ratings

Parameter	Value	Unit
Operating Supply voltage	4.75~40	V
Operating Temperature Range	-40~85	°C
Thermal Resistance, R _{θJA}	150	°C/W

Electronics Characteristics (Ta=25°C, V_{IN}=12V, C_{IN}=C_{OUT}=10uF, unless otherwise noted)

Symbol	Parameter	Test Condition	WL2851E SPEC			Unit
			Min.	Typ.	Max.	
V _{IN}	Input Range	I _{OUT} =10mA	4.75		40	V
V _{OUT}	Output Range	I _{OUT} =10mA	V _{OUT} *0.98	V _{OUT}	V _{OUT} *1.02	V
ΔV _{OUT}	Output Voltage	V _{IN} =12V, I _{OUT} =10mA	3.234	3.3	3.366	V
			4.9	5.0	5.1	V
I _{OUT_PK}	Maximum Output Current	V _{IN} =12V, R _L =1Ω	180	280	460	mA
I _Q	Quiescent Current	V _{IN} =7V, No load		10	15	μA
		V _{IN} =24V, No load		11	16	
		V _{IN} =40V, No load		13	20	
V _{DROP}	Dropout Voltage	I _{OUT} =1mA		8	12	mV
		I _{OUT} =30mA		240	400	
ΔV _{Line}	Line Regulation	V _{IN} =7--24V, V _{OUT} =5V I _{OUT} =1mA		0.02		%V
		V _{IN} =7--45V, V _{OUT} =5V I _{OUT} =1mA		0.1		
ΔV _{Load}	Load Regulation	V _{IN} =12V, I _{OUT} =1--100mA		0.6		%
e _{NO}	Output Noise	I _{OUT} =10mA	-100		+100	μV
PSRR	Ripple Rejection	V _{IN} =10V V _{PP} =0.5V I _{OUT} =1mA	f=100Hz	60		dB
			f=1KHz	45		
			f=10KHz	35		
T _{SD}	Thermal Protection	V _{IN} =12V, I _{OUT} =1mA		165		°C
T _{SD_HYS}	Thermal Protection Hys	V _{IN} =12V, I _{OUT} =1mA		30		°C
ΔVo/ΔT	Temperature Coefficient	V _{IN} =12V, I _{OUT} =1mA		±0.5		mv/°C

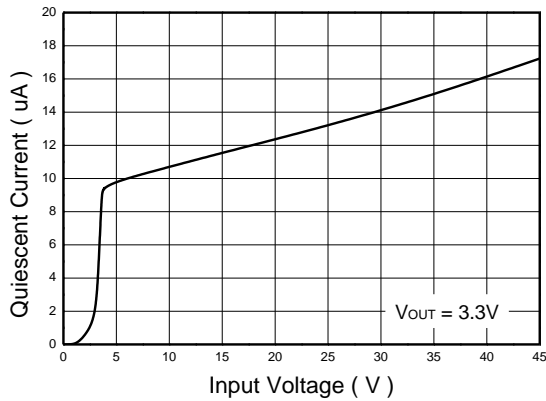
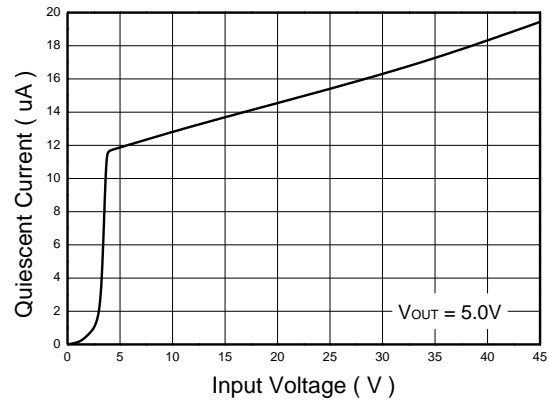
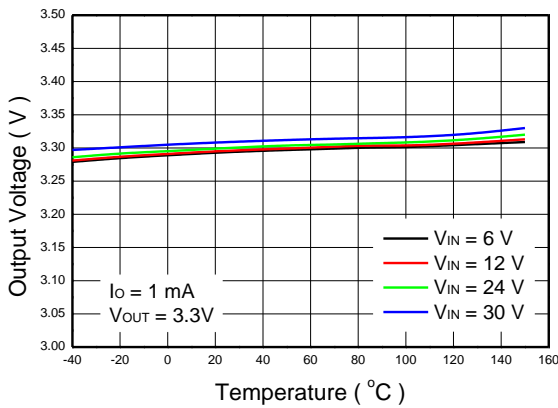
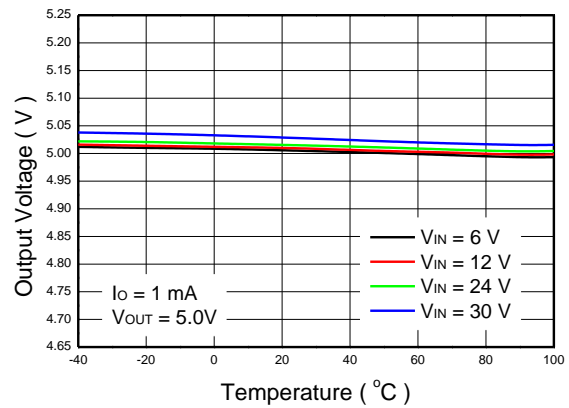
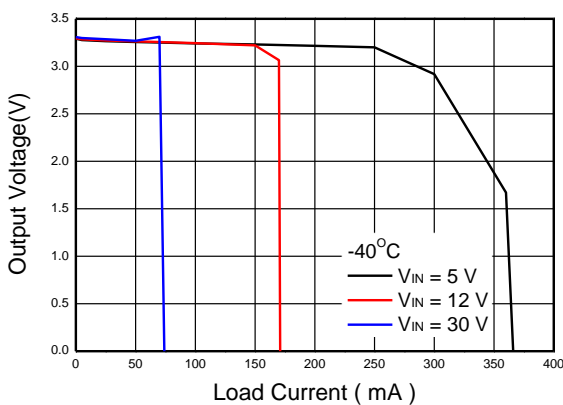
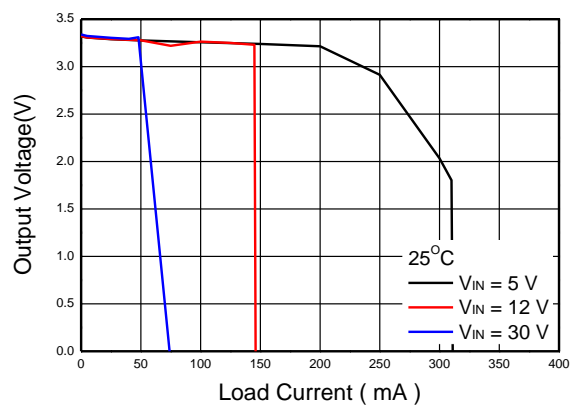
Typical characteristics (Ta=25°C CIN=COUT=10uF, unless otherwise noted)

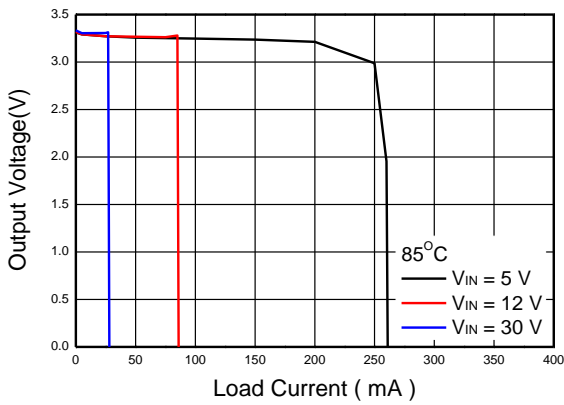
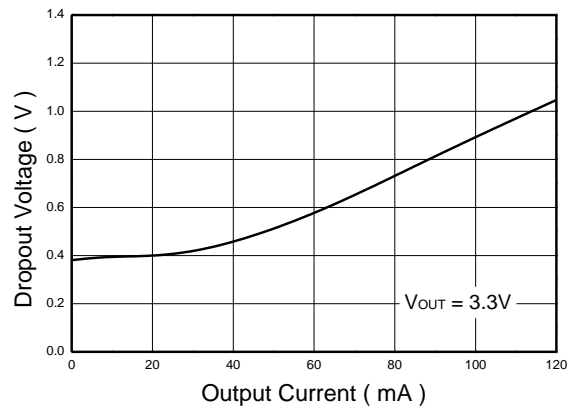
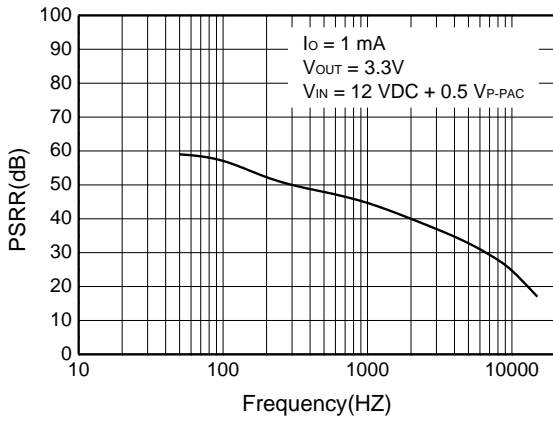
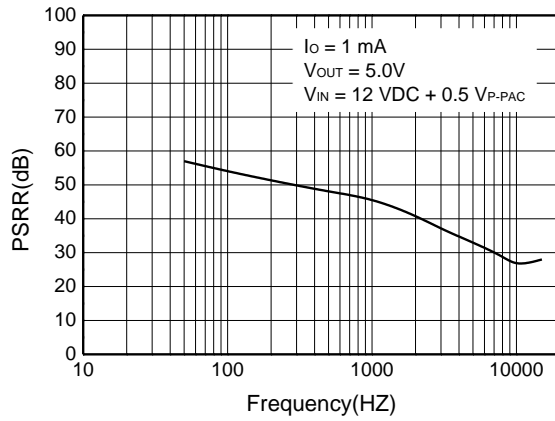
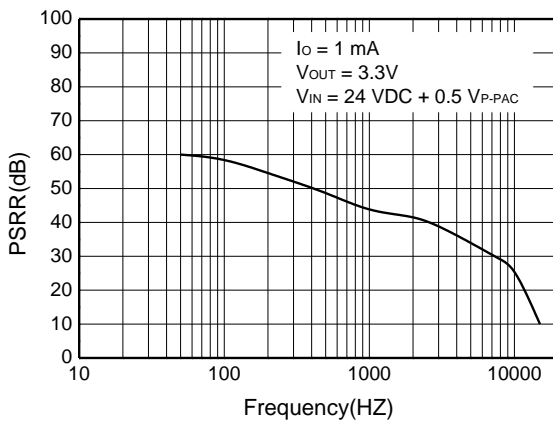
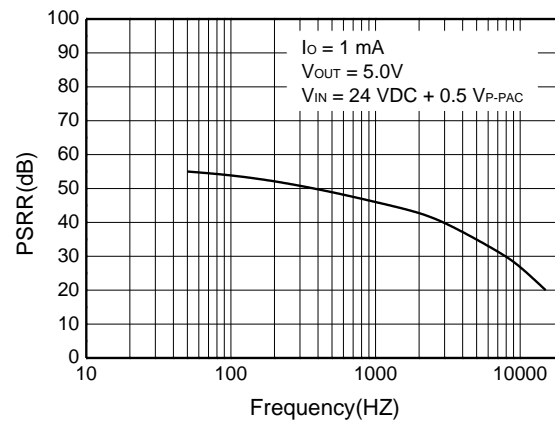
Quiescent Current vs. Input Voltage

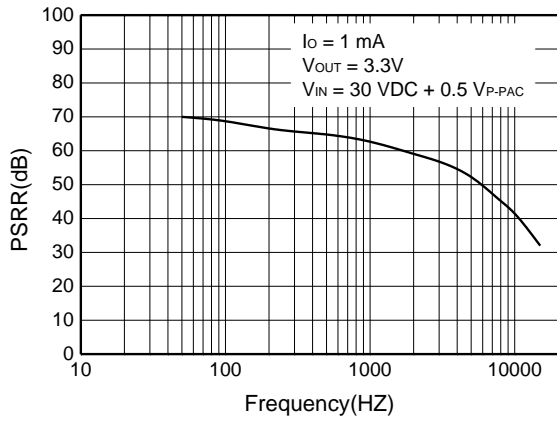
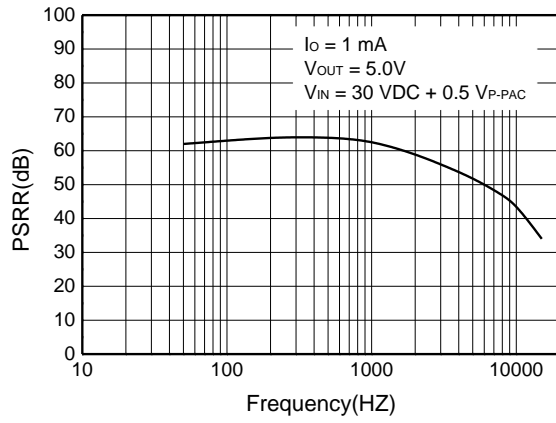
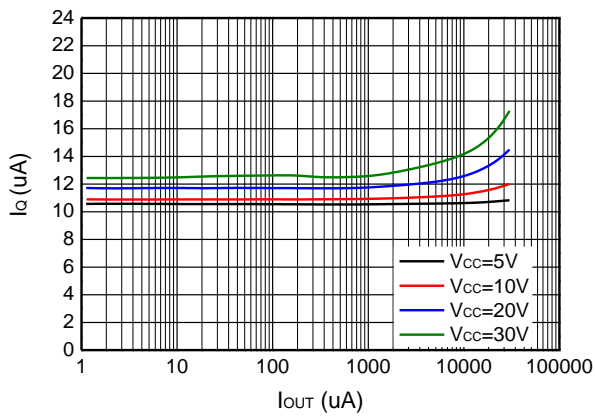
Quiescent Current vs. Input Voltage

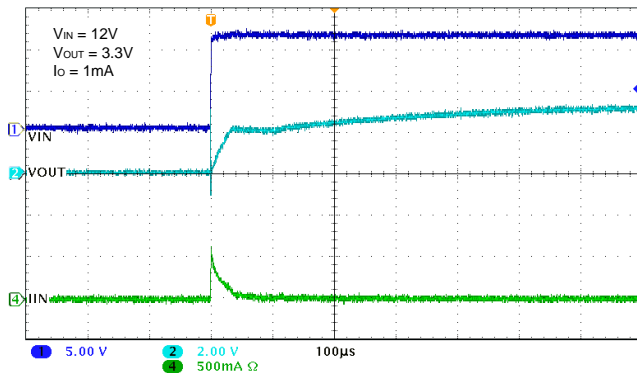
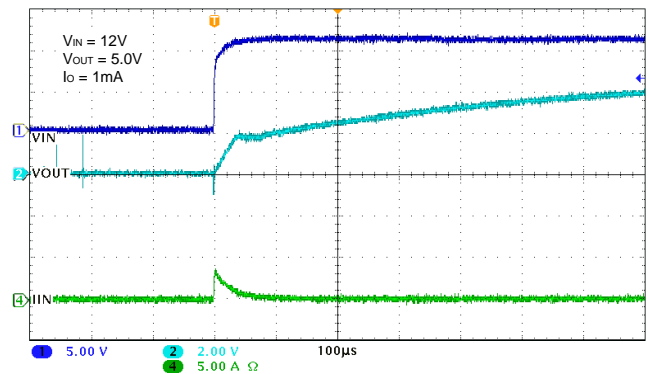
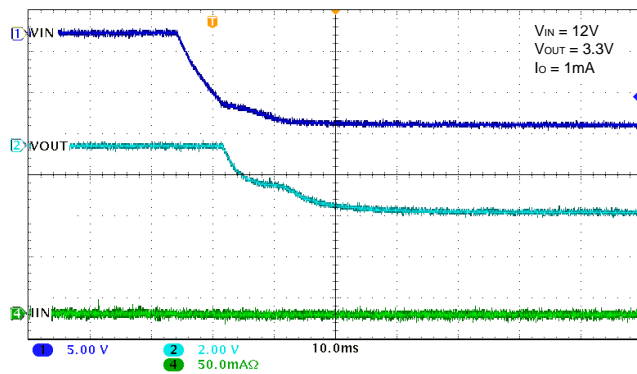
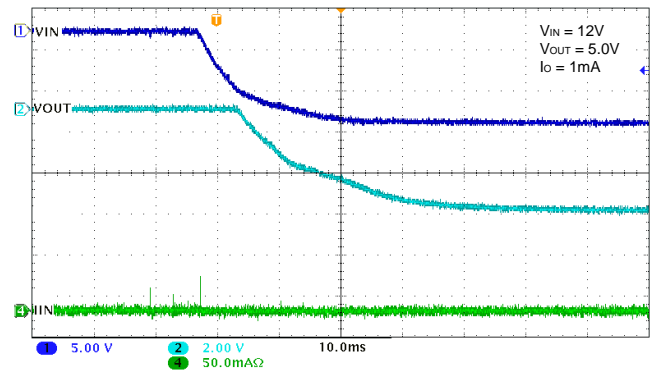
Output Voltage vs. Temperature

Output Voltage vs. Temperature

Output Voltage vs. Load Current

Output Voltage vs. Load Current

Output Voltage vs. Load Current

Dropout Voltage vs. Output Current

PSRR vs. Frequency

PSRR vs. Frequency

PSRR vs. Frequency

PSRR vs. Frequency

PSRR vs. Frequency

PSRR vs. Frequency

Quiescent Current vs. Output Current



Startup from Power ON

Startup from Power ON

Shutdown from Power OFF

Shutdown from Power OFF

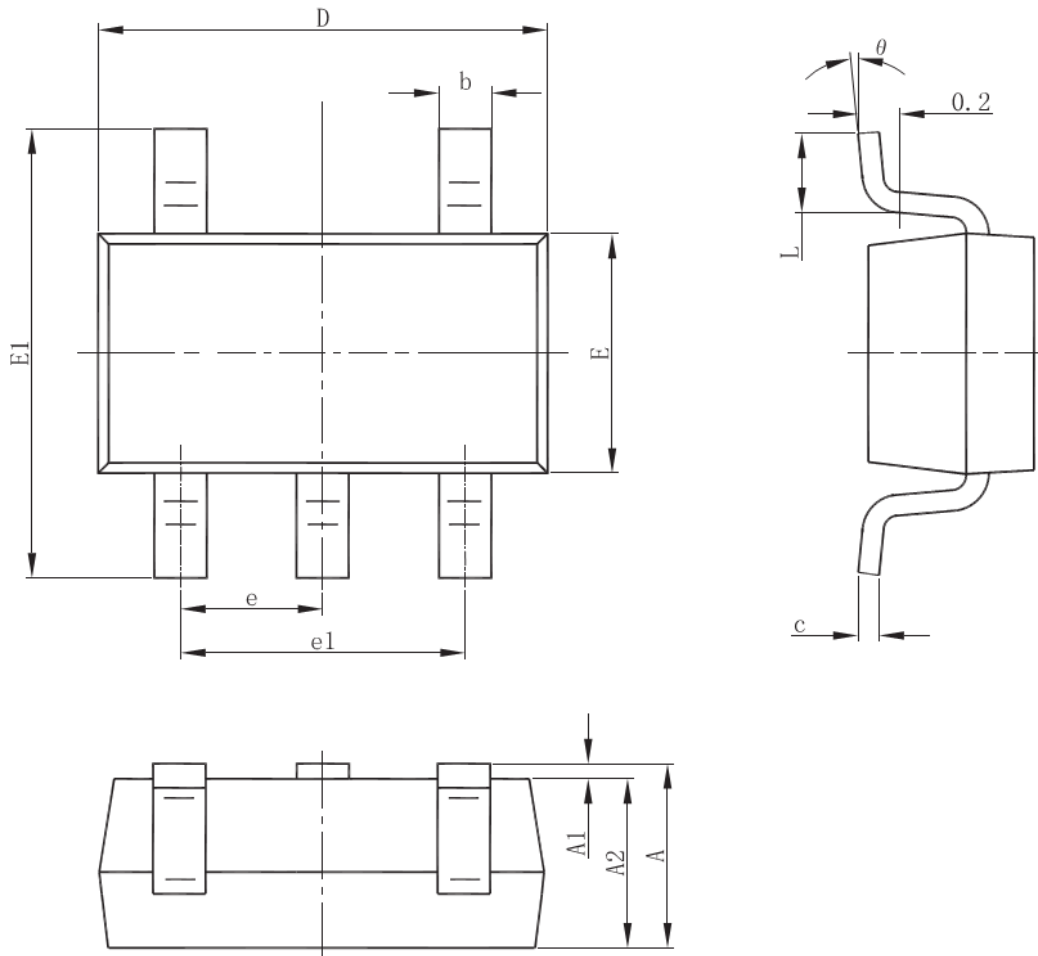
ORDER INFORMATION

Ordering No.	Vout (V)	Package	Operating Temperature	Marking	Shipping
WL2851E33-5/TR	3.3	SOT-23-5L	-40~+85°C	WB33 EAYW	Tape and Reel, 3000
WL2851E50-5/TR	5.0	SOT-23-5L	-40~+85°C	WB50 EAYW	Tape and Reel, 3000

Marking:

WB* = Device Code
EA = Package Code
Y = Year
W = Week

Package outline dimensions
SOT-23-5L

Symbol	Dimensions In Millimeters		
	Min.	Typ.	Max.
A	-	-	1.250
A1	0.000	-	0.150
A2	1.000	1.100	1.200
b	0.360	-	0.500
c	0.140	-	0.200
D	2.826	2.926	3.026
E	1.526	1.626	1.726
E1	2.600	2.800	3.000
e	0.900	0.950	1.000
e1	1.800	1.900	2.000
L	0.350	0.450	0.600
θ	0°	-	8°