

TSF4N90M

900V N-Channel MOSFET

General Description

This Power MOSFET is produced using Truesemi's advanced planar stripe DMOS technology. This advanced technology has been especially tailored to minimize on-state resistance, provide superior switching performance, and withstand high energy pulse in the avalanche and commutation mode. These devices are well suited for high efficiency switched mode power supplies, active power factor correction based on half bridge topology.



Features

- Drain-Source breakdown voltage: BVDSS=900V (Min.)
- Low gate charge: Qg=22nC (Typ.)
- Low drain-source On resistance: RDS(on)=4.2Ω (Max.)
- 100% avalanche tested
- RoHS compliant device

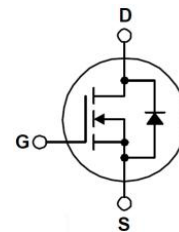

Absolute maximum ratings (T_c=25°C unless otherwise noted)

Characteristic	Symbol	Rating	Unit	
Drain-source voltage	V _{DSS}	900	V	
Gate-source voltage	V _{GSS}	±30	V	
Drain current (DC) *	I _D	T _c =25°C	4	A
		T _c =100°C	2.53	A
Drain current (Pulsed) *	I _{DM}	16	A	
Single avalanche current ^(Note 2)	I _{AS}	4	A	
Single pulsed avalanche energy ^(Note 2)	E _{AS}	84.7	mJ	
Repetitive avalanche current ^(Note 1)	I _{AR}	4	A	
Repetitive avalanche energy ^(Note 1)	E _{AR}	4	mJ	
Power dissipation	P _D	40	W	
Junction temperature	T _J	150	°C	
Storage temperature range	T _{stg}	-55-150	°C	

* Limited only maximum junction temperature

Thermal Characteristics

Characteristic	Symbol	Rating	Unit
Thermal resistance, junction to case	$R_{th(j-c)}$	Max. 3.13	°C/W
Thermal resistance, junction to ambient	$R_{th(j-a)}$	Max. 62.5	

Electrical Characteristics ($T_C=25^\circ\text{C}$ unless otherwise noted)

Characteristic	Symbol	Test Condition	Min.	Typ.	Max.	Unit
Drain-source breakdown voltage	BV_{DSS}	$I_D=250\mu\text{A}$, $V_{GS}=0\text{V}$	900	-	-	V
Gate threshold voltage	$V_{GS(th)}$	$I_D=250\mu\text{A}$, $V_{DS}=V_{GS}$	3	4	5	V
Drain-source cut-off current	I_{DSS}	$V_{DS}=900\text{V}$, $V_{GS}=0\text{V}$	-	-	1	μA
Gate leakage current	I_{GSS}	$V_{DS}=0\text{V}$, $V_{GS}=\pm 30\text{V}$	-	-	± 100	nA
Drain-source on-resistance	$R_{DS(ON)}$	$V_{GS}=10\text{V}$, $I_D=2\text{A}$	-	3.7	4.2	Ω
Forward transfer conductance (Note 3)	g_{fs}	$V_{DS}=10\text{V}$, $I_D=2\text{A}$	-	4	-	S
Input capacitance	C_{ISS}	$V_{DS}=25\text{V}$, $V_{GS}=0\text{V}$, $f=1.0\text{MHz}$	-	750	-	pF
Output capacitance	C_{OSS}		-	62	-	
Reverse transfer capacitance	C_{RSS}		-	12	-	
Turn-on delay time (Note 3,4)	$t_{d(on)}$	$V_{DD}=450\text{V}$, $I_D=4\text{A}$, $R_G=25\Omega$	-	38	-	ns
Rise time (Note 3,4)	t_r		-	60	-	
Turn-off delay time (Note 3,4)	$t_{d(off)}$		-	68	-	
Fall time (Note 3,4)	t_f		-	54	-	
Total gate charge (Note 3,4)	Q_g	$V_{DS}=720\text{V}$, $V_{GS}=10\text{V}$, $I_D=4\text{A}$	-	22	-	nC
Gate-source charge (Note 3,4)	Q_{gs}		-	8	-	
Gate-drain charge (Note 3,4)	Q_{gd}		-	7	-	

Source-Drain Diode Ratings and Characteristics ($T_C=25^\circ\text{C}$ unless otherwise noted)

Characteristic	Symbol	Test Condition	Min.	Typ.	Max.	Unit
Source current (DC)	I_S	Integral reverse diode in the MOSFET	-	-	4	A
Source current (Pulsed)	I_{SM}		-	-	16	A
Forward voltage	V_{SD}	$V_{GS}=0\text{V}$, $I_S=4\text{A}$	-	-	1.4	V
Reverse recovery time (Note 3,4)	t_{rr}	$I_S=4\text{A}$, $V_{GS}=0\text{V}$ $dI_F/dt=100\text{A}/\mu\text{s}$	-	301	-	ns
Reverse recovery charge (Note 3,4)	Q_{rr}		-	2.06	-	μC

Note:

1. Repeated rating: Pulse width limited by safe operating area
2. $L=10\text{mH}$, $I_{AS}=4\text{A}$, $V_{DD}=50\text{V}$, $R_G=25\Omega$, Starting $T_J=25^\circ\text{C}$
3. Pulse test: Pulse width $\leq 300\mu\text{s}$, Duty cycles $\leq 2\%$
4. Essentially independent of operating temperature typical characteristics

Electrical Characteristics Curves

Fig. 1 Typical Output Characteristics

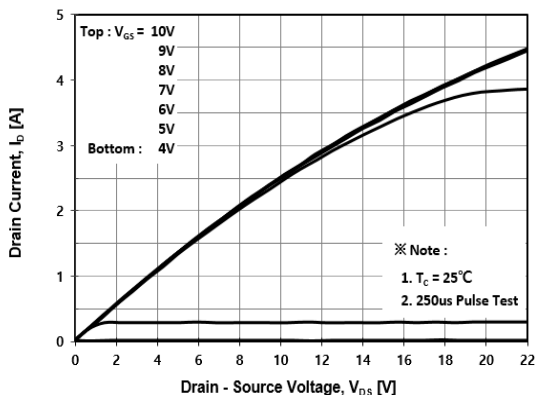

Fig. 2 Typical Transfer Characteristics

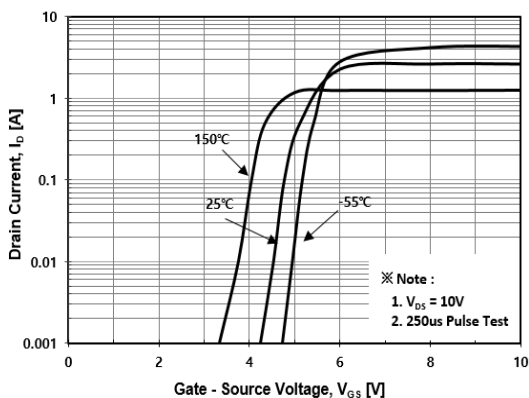

Fig.3 On-Resistance Variation with Drain Current and Gate Voltage

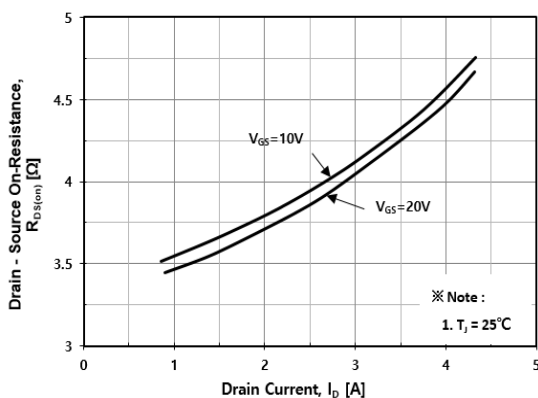

Fig. 4 Body Diode Forward Voltage Variation with Source Current

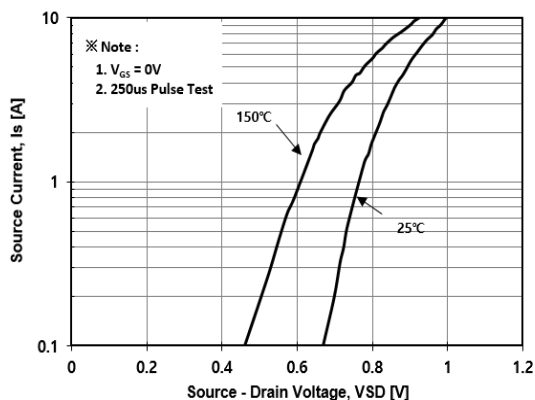

Fig. 5 Typical Capacitance Characteristics

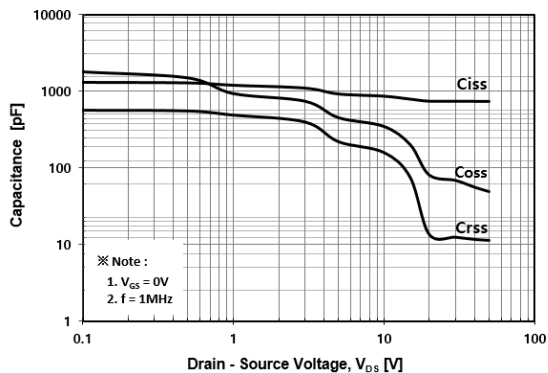
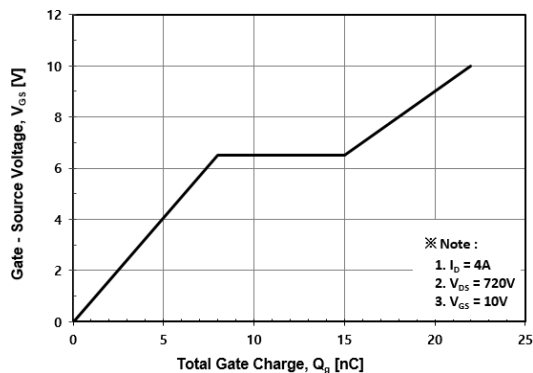

Fig. 6 Typical Total Gate Charge Characteristics



Electrical Characteristics Curves

Fig. 7 Breakdown Voltage Variation vs. Temperature

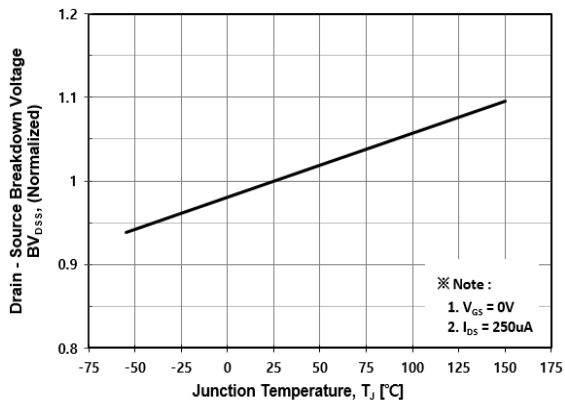

Fig. 8 On-Resistance Variation vs. Temperature

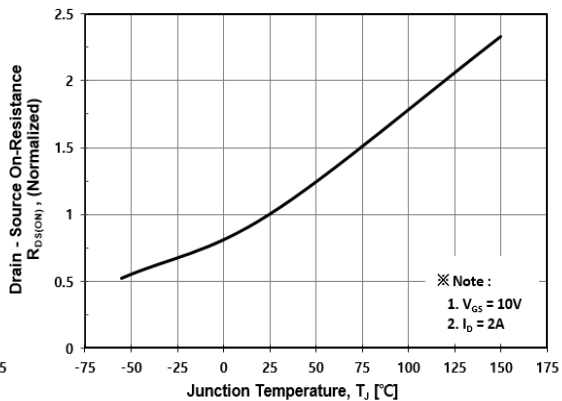

Fig. 9 Maximum Drain Current vs. Case Temperature

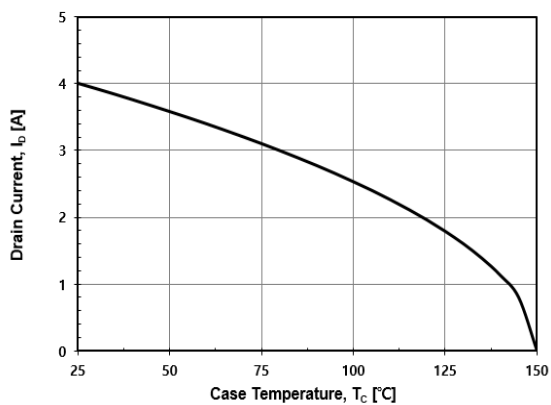

Fig. 10 Maximum Safe Operating Area

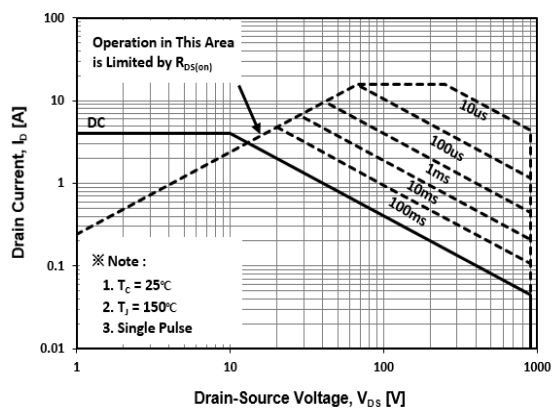

Fig. 11 Transient Thermal Impedance

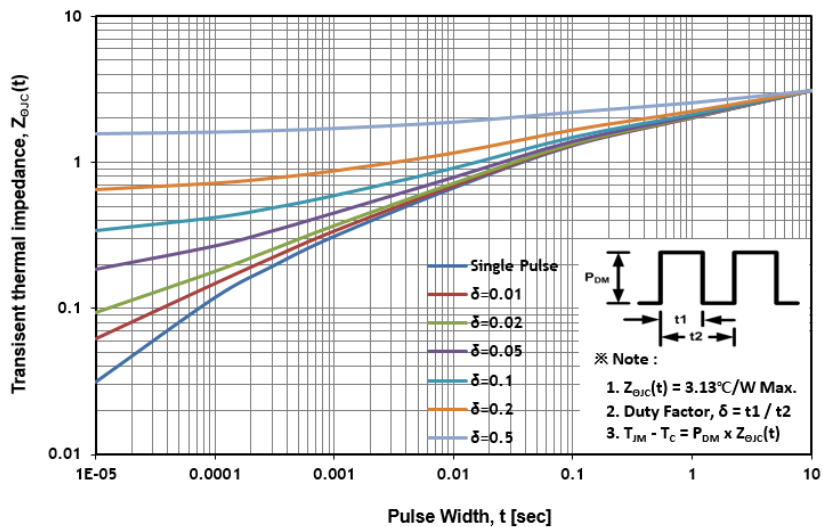

Fig. 12 Gate Charge Test Circuit & Waveform

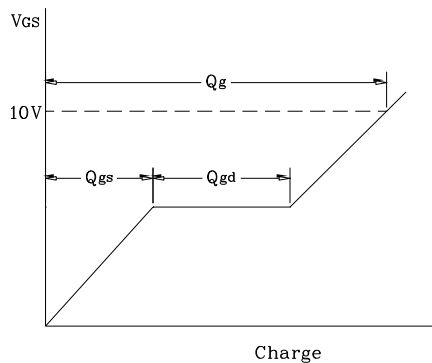
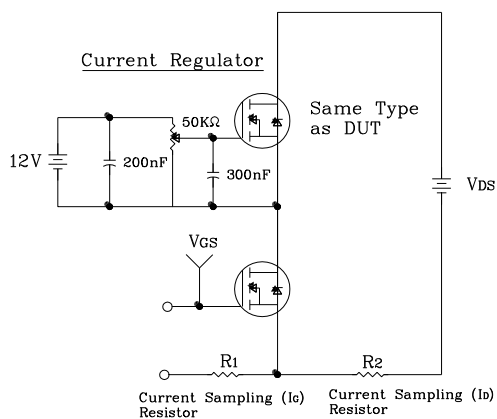

Fig. 13 Resistive Switching Test Circuit & Waveform

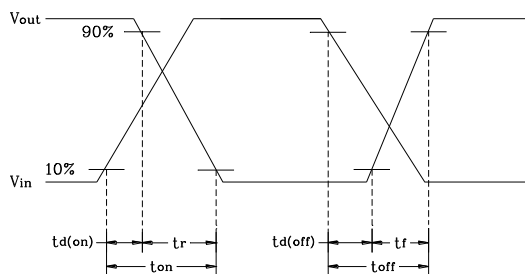
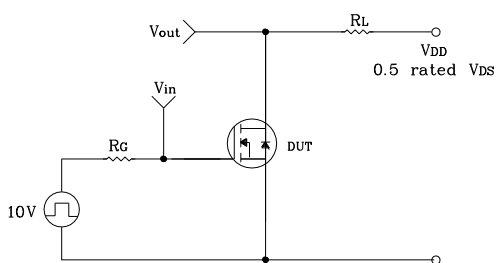

Fig. 14 E_{AS} Test Circuit & Waveform

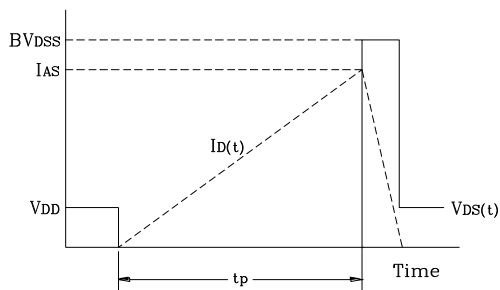
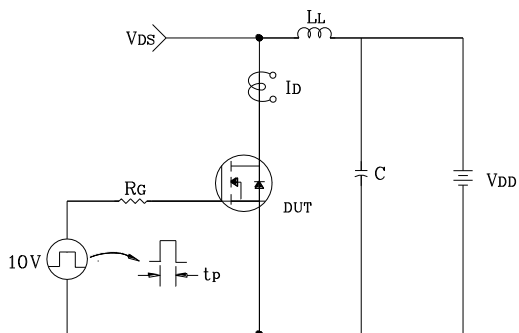

Fig. 15 Diode Reverse Recovery Time Test Circuit & Waveform

