

承 认 书

SPECIFICATION FOR APPROVAL

客户 (CUSTOMER): _____

产品名称 (PRODUCT NAME): 电磁式蜂鸣器 (外部驱动)

型号 (TYPE): YS-MBZ9042C03R16

客户料号 (CUSTOMER NO) _____

日期 (DATE): 2019-07-20

客户确认: (签章)
日期:

东 莞 市 锋 鸣 电 子 有 限 公 司

电话: 0769-88036425

传真: 0769-85474556

制单: 李琳

业务: 宋浩亮

工程: 黄鑫

FENGMING TECH OF DONGGUAN CO.,LTD

YS-MBZ9042C03R16

DIMENSIONS Unit:mm Tolerance: ± 0.5

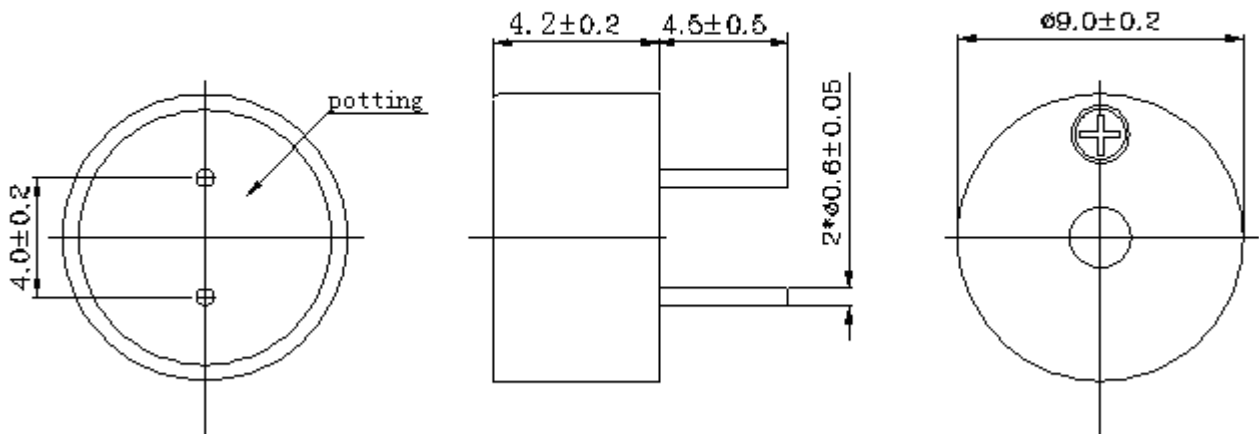

SPECIFICATIONS

Model NO	YS-MBZ9042C03R16
Rated Voltage	3V
Operating Voltage	2.0~4.0V
Rated Current	Max. 60mA
Coil Resistance	$16 \pm 4 \Omega$
sound Pressure level(dB/2700Hz/at 10cm)	Min.80dB
Resonant Frequency	2700Hz
Operating Temperature	-20 °C~+70 °C
Storage Temperature	-30 °C~+80 °C

Acoustic Characteristics:

The oscillation frequency, current consumption and sound pressure are measured by the measuring instruments shown below

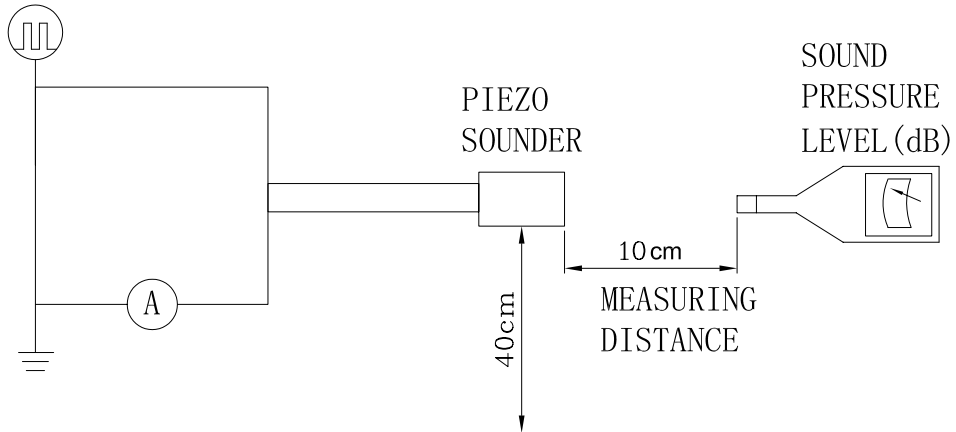

In the measuring test, buzzer is placed as follows:

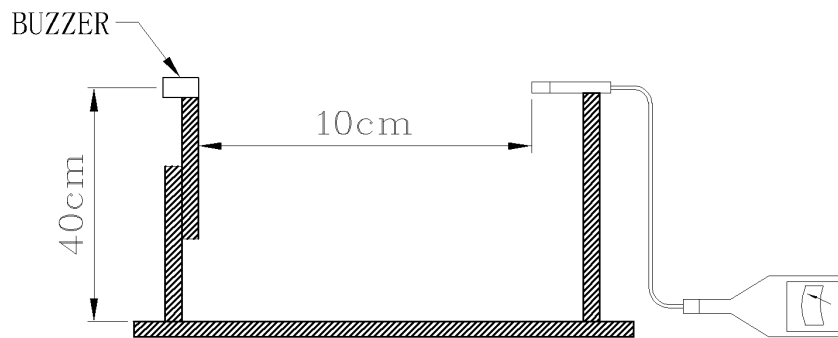

Typical Frequency Response Curve

