

1. General Features

- n Proprietary New Trench Technology
- n $R_{DS(ON),typ.}=6.5m\Omega@V_{GS}=10V$
- n Low Gate Charge Minimize Switching Loss
- n Fast Recovery Body Diode

2. Applications

- n High efficiency DC/DC converters
- n Synchronous Rectification
- n UPS Inverter

3. Pin configuration

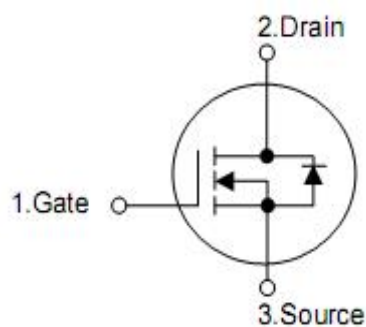
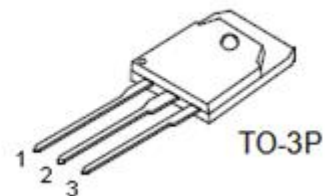
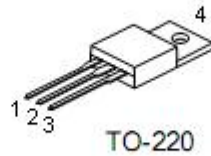
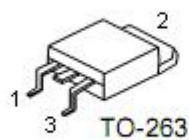

Pin	Function
1	Gate
2	Drain
3	Source
4	Drain

4. Ordering Information

Part Number	Package	Brand
KND3208A	TO-252	KIA
KNB3208A	TO-263	KIA
KNP3208A	TO-220	KIA
KNH3208A	TO-3P	KIA

5. Absolute maximum ratings

(T_C= 25 °C , unless otherwise specified)

Symbol	Parameter	Rating			Unit
		TO-252	TO-263/220	TO-3P	
V _{DSS}	Drain-to-Source Voltage ^[1]	85			V
V _{GSS}	Gate-to-Source Voltage	±20			
I _D	Continuous Drain Current ^[2]	100*	100	100	A
	Continuous Drain Current@T _C =100 °C ^[3]	70*	70	70	
I _{DM}	Pulsed Drain Current at V _{GS} =10V ^[2,4]	400*	400	400	
E _{AS}	Single Pulse Avalanche Energy(L=1mH)	612			mJ
dv /dt	Peak Diode Recovery dv/dt ^[3]	5.0			V/ns
P _D	Power Dissipation	65	189	224	W
	Derating Factor above 25 °C	0.43	1.3	1.49	W/ °C
T _L T _{PAK}	Maximum Temperature for Soldering Leads at 0.063in (1.6mm) from Case for 10 seconds, Package Body for 10 seconds	300 260			°C
T _J &T _{STG}	Operating and Storage Temperature Range	-55 to 175			

Caution: Stresses greater than those listed in the “Absolute Maximum Ratings” may cause permanent damage to the device.

* Drain current limited by maximum junction temperature.

6. Thermal characteristics

Symbol	Parameter	Rating			Unit
		TO-252	TO-263/220	TO-3P	
R _{θJC}	Thermal Resistance, Junction-to-Case	2.3	0.79	0.67	°C /W
R _{θJA}	Thermal Resistance, Junction-to-Ambient	95	62	52	

6. Electrical characteristics

OFF Characteristics		(T _J =25°C, unless otherwise specified)				
Symbol	Parameter	Test Conditions	Min.	Typ.	Max.	Unit
BV _{DSS}	Drain-to-Source Breakdown Voltage	V _{GS} =0V, I _D =250uA	85	--	--	V
I _{DSS}	Drain-to-Source Leakage Current	V _{DS} =80V, V _{GS} =0V	--	--	1	uA
		V _{DS} =64V, V _{GS} =0V, T _J =125°C	--	--	100	
I _{GSS}	Gate-to-Source Leakage Current	V _{GS} =+20V, V _{DS} =0V	--	--	+100	nA
		V _{GS} =-20V, V _{DS} =0V	--	--	-100	
ON Characteristics		(T _J =25°C, unless otherwise specified)				
Symbol	Parameter	Test Conditions	Min.	Typ.	Max.	Unit
R _{DS(ON)}	Static Drain-to-Source On-Resistance	V _{GS} =10V, I _D =24A ^[5]	--	6.5	8.0	mΩ
V _{GS(TH)}	Gate Threshold Voltage	V _{DS} =V _{GS} , I _D =250uA	2.0	--	4.0	V
Dynamic Characteristics		Essentially independent of operating temperature				
Symbol	Parameter	Test Conditions	Min.	Typ.	Max.	Unit
C _{iss}	Input Capacitance	V _{GS} =0V, V _{DS} =25V, f=1.0MHZ	--	3420	--	pF
C _{oss}	Output Capacitance		--	400	--	
C _{rss}	Reverse Transfer Capacitance		--	120	--	
R _g	Gate Series Resistance	f=1.0MHZ	--	2.0	--	Ω
Q _g	Total Gate Charge	V _{DD} =40V, I _D =80A, V _{GS} =0 to 10V	--	61	--	nC
Q _{gs}	Gate-to-Source Charge		--	20	--	
Q _{gd}	Gate-to-Drain (Miller) Charge		--	18	--	
Resistive Switching Characteristics		Essentially independent of operating temperature				
Symbol	Parameter	Test Conditions	Min.	Typ.	Max.	Unit
t _{d(ON)}	Turn-on Delay Time	V _{DD} =40V, I _D =80A, V _{GS} = 10V, R _G =2.5Ω	--	22	--	nS
t _{rise}	Rise Time		--	24	--	
t _{d(OFF)}	Turn-Off Delay Time		--	100	--	
t _{fall}	Fall Time		--	32	--	
Source-Drain Body Diode Characteristics		(T _J =25°C, unless otherwise specified)				
Symbol	Parameter	Test Conditions	Min	Typ.	Max.	Unit
I _{SD}	Continuous Source Current ^[2]	Integral PN-diode in MOSFET	--	--	100	A
I _{SM}	Pulsed Source Current ^[2]		--	--	400	
V _{SD}	Diode Forward Voltage	I _S =80A, V _{GS} =0V	--	--	1.3	V
t _{rr}	Reverse recovery time	V _{GS} =0V, I _F =20A, diF/dt=100A/μs	--	40	--	ns
Q _{rr}	Reverse recovery charge		--	80	--	uC

Note:

[1] T_J = +25 °C to +175 °C.

[2] Silicon limited current only.

[3] Package limited current 80A.

[4] Repetitive rating; pulse width limited by maximum junction temperature.

[5] Pulse width ≤ 380μs; duty cycle ≤ 2%.

7. Test circuits and waveforms

Figure 1. Maximum Effective Thermal Impedance, Junction-to-Case

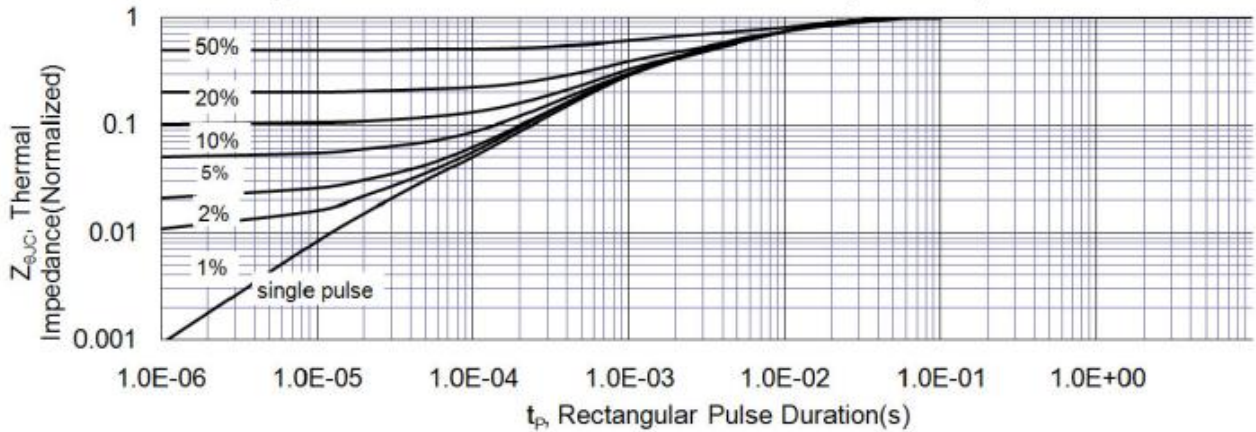

Figure 2. Maximum Power Dissipation vs. Case Temperature

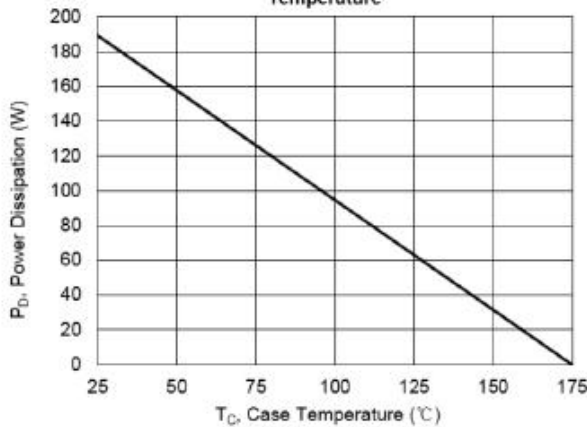

Figure 3. Maximum Continuous Drain Current vs Tc

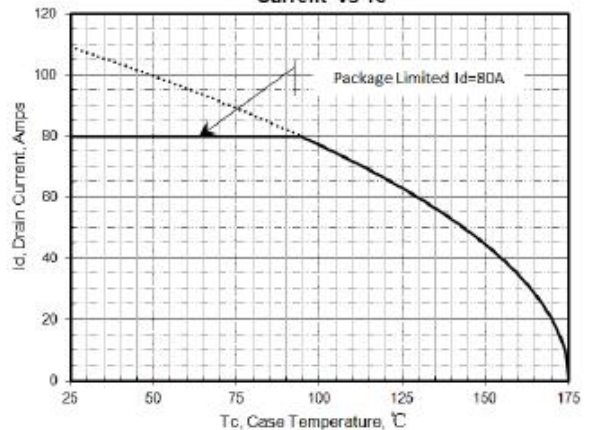

Figure 4. Typical Output Characteristics

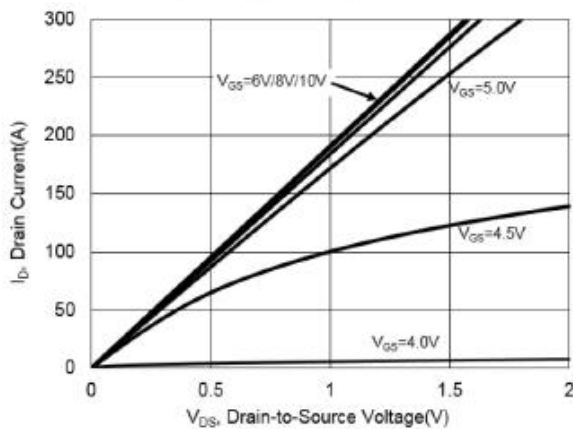

Figure 5. R_dson vs Gate Voltage

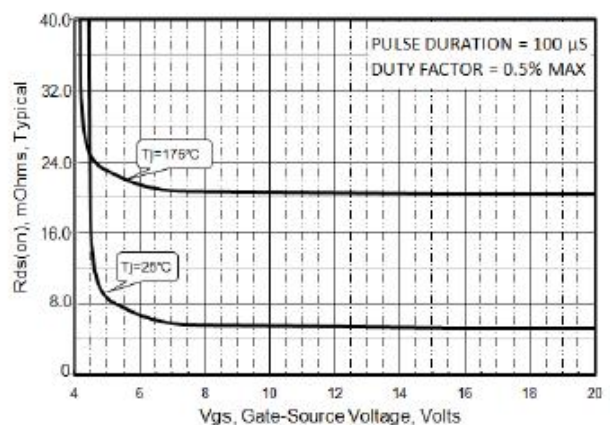

Figure 6. Maximum Peak Current Capability

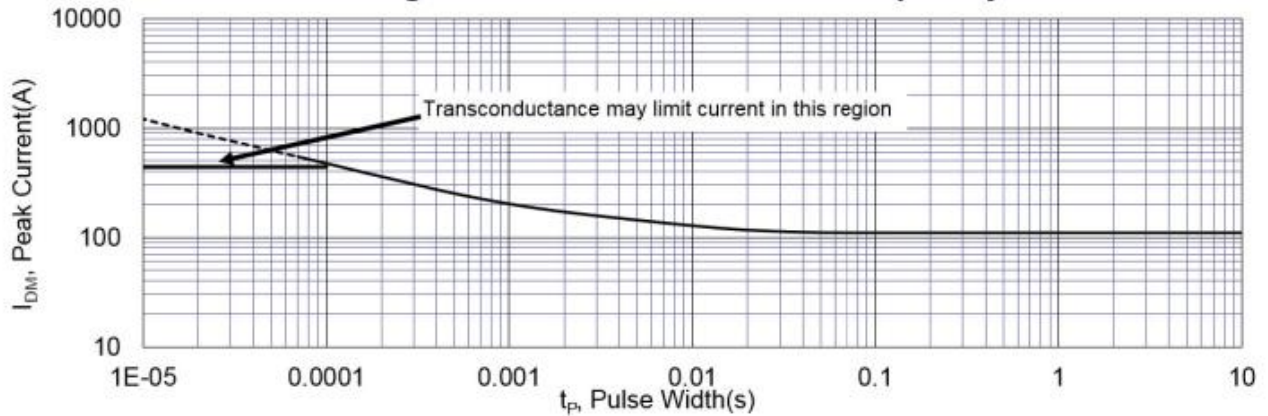

Figure 7. Typical Transfer Characteristics

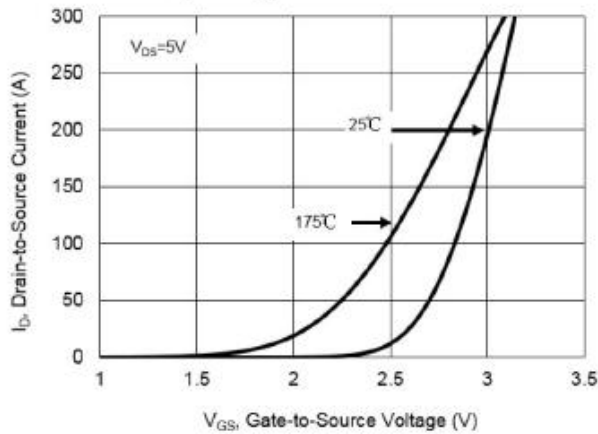

Figure 8. Unclamped Inductive Switching Capability

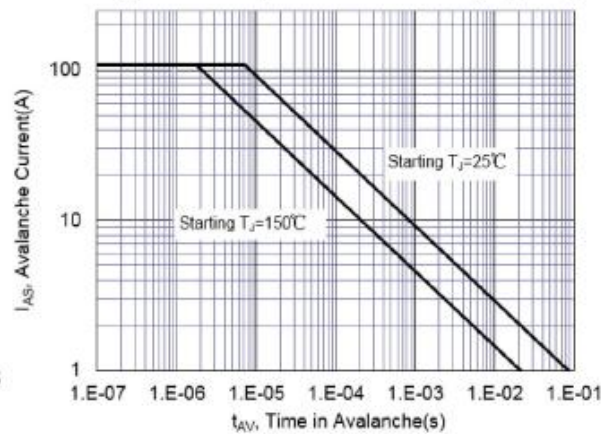

Figure 9. Typical Drain-to-Source ON Resistance

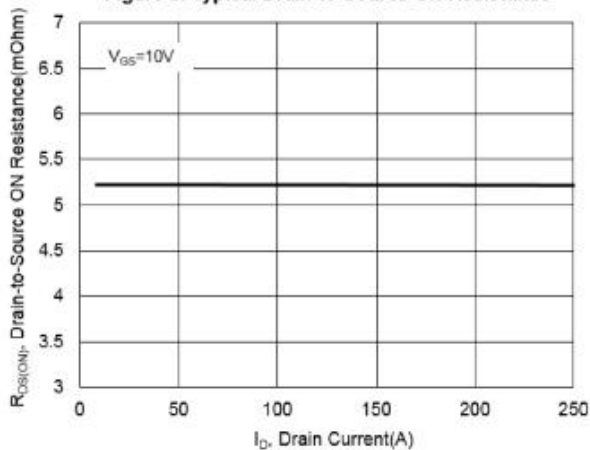
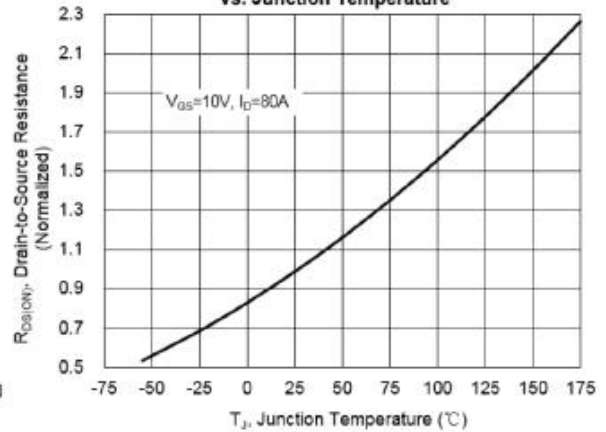
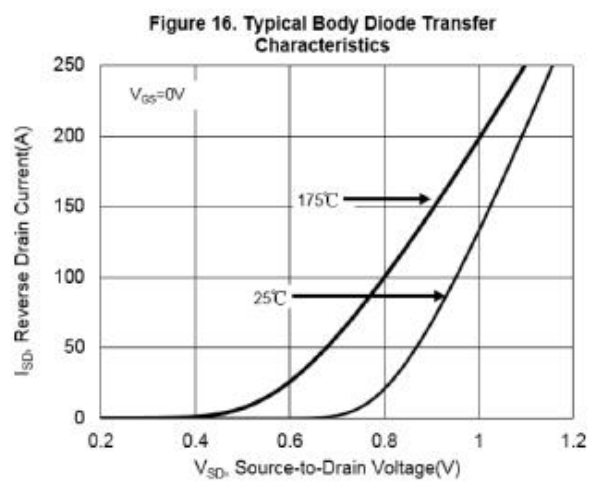
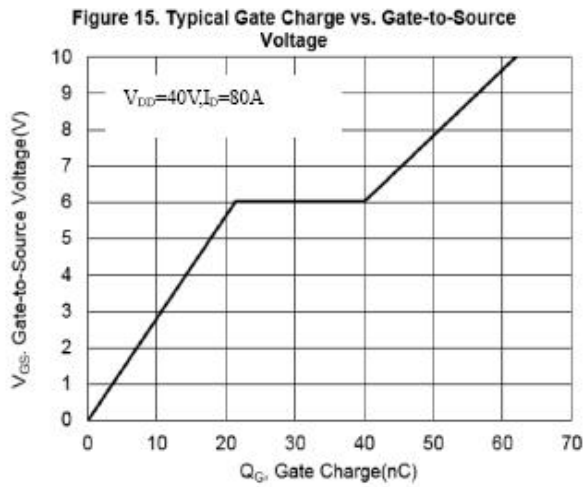
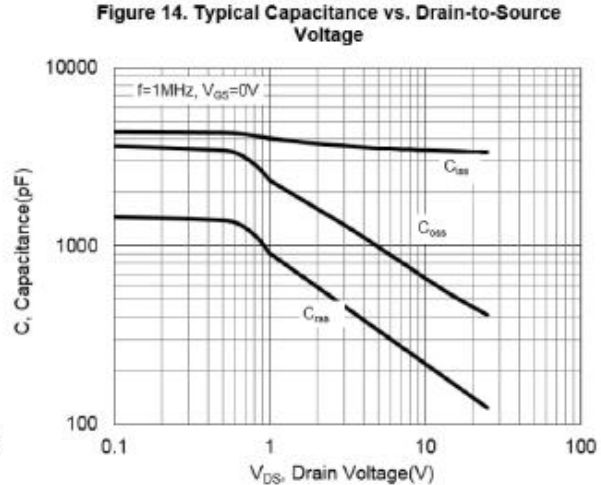
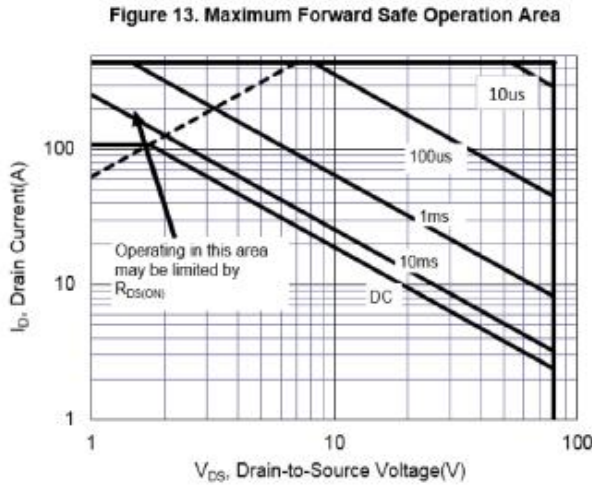
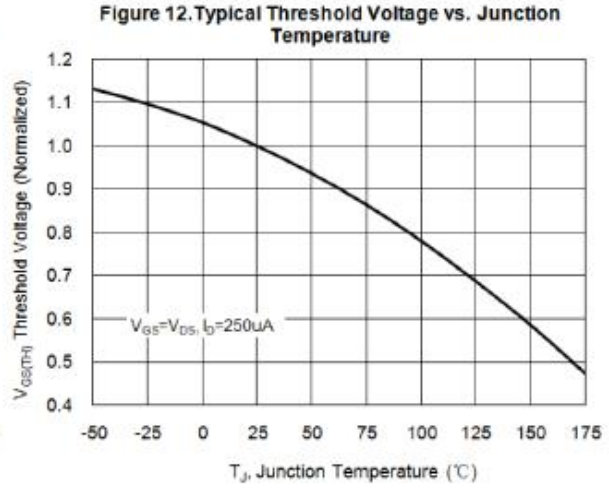
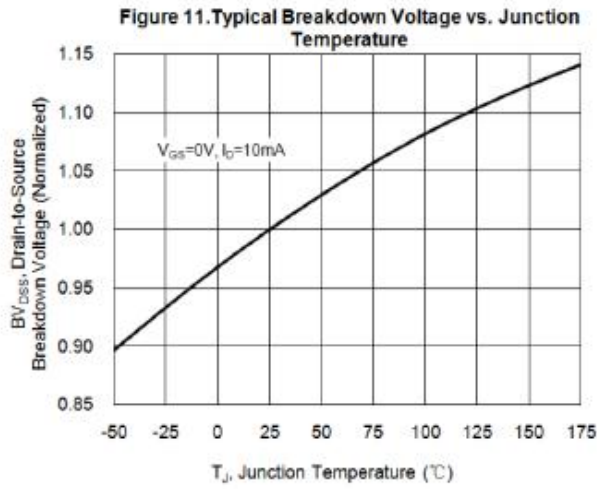

Figure 10. Typical Drain-to-Source On Resistance vs. Junction Temperature





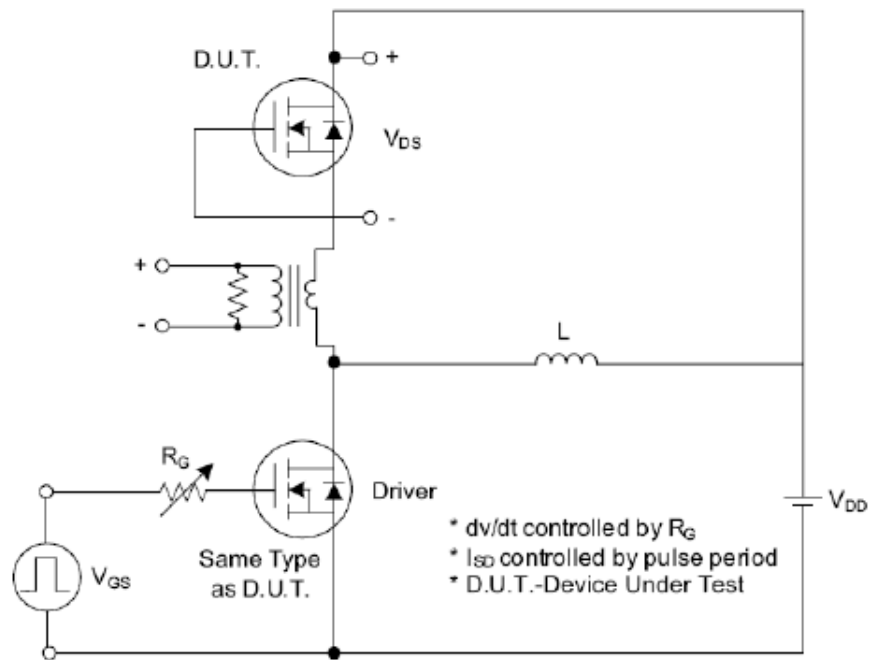

Fig. 1.1 Peak Diode Recovery dv/dt Test Circuit

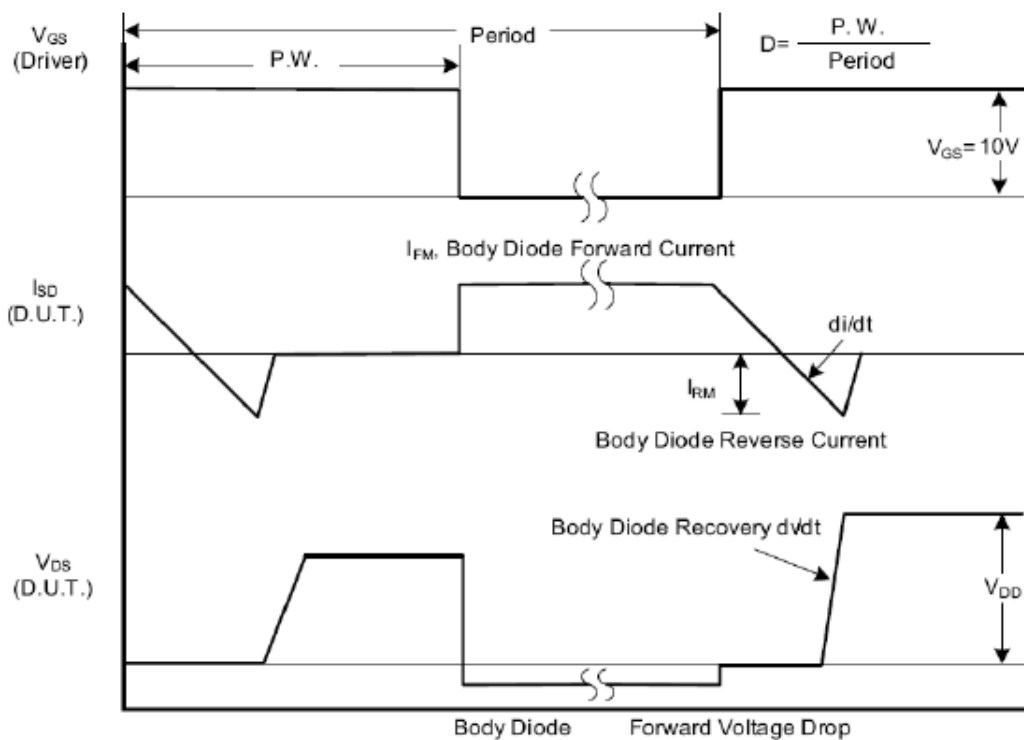

Fig. 1.2 Peak Diode Recovery dv/dt Waveforms

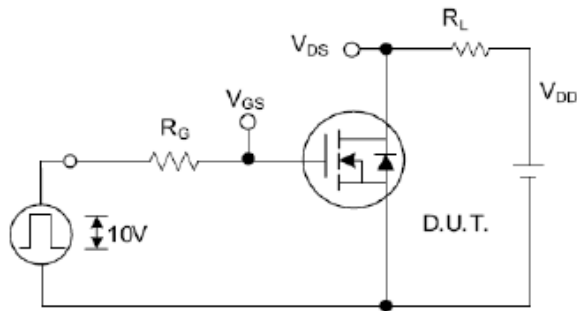

Fig. 2.1 Switching Test Circuit

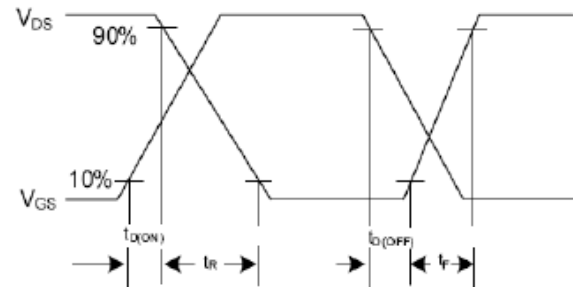

Fig. 2.2 Switching Waveforms

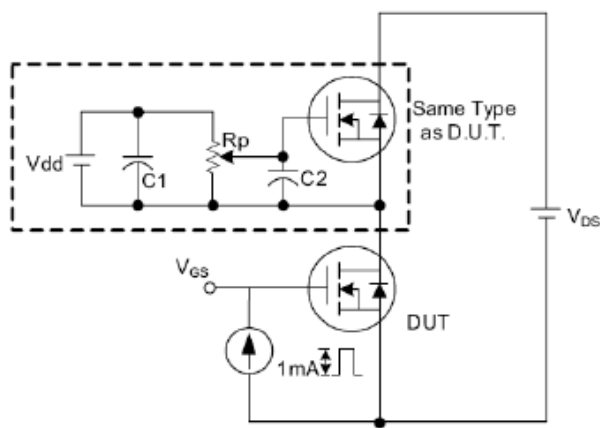

Fig. 3.1 Gate Charge Test Circuit

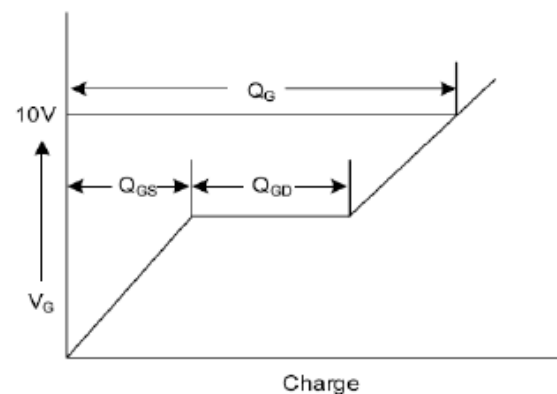

Fig. 3.2 Gate Charge Waveform

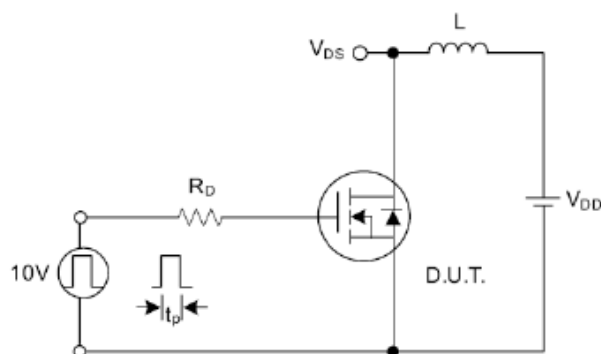

Fig. 4.1 Unclamped Inductive Switching Test Circuit

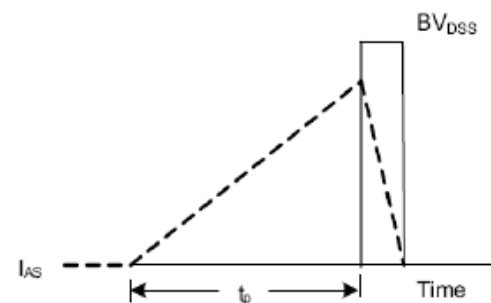

Fig. 4.2 Unclamped Inductive Switching Waveforms