

# 16N65MF

## 16 Amps,650 Volts N-CHANNEL MOSFET

### FEATURE

- 16A,650V, $R_{DS(ON)MAX}=0.45\ \Omega$  @ $V_{GS}=10V/8A$
- Low gate charge
- Low  $C_{iss}$
- Fast switching
- 100% avalanche tested
- Improved dv/dt capability

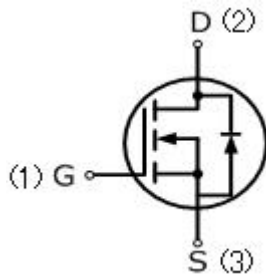

### TO-220MF

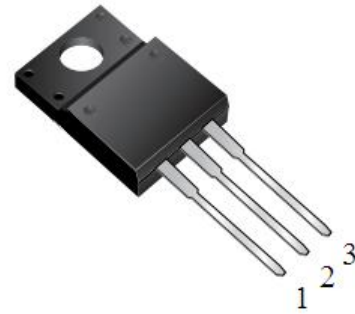

### Absolute Maximum Ratings( $T_C=25^\circ\text{C}$ , unless otherwise noted)

Parameter	Symbol	16N65MF	UNIT
Drain-Source Voltage	$V_{DSS}$	650	V
Gate-Source Voltage	$V_{GSS}$	$\pm 30$	
Continuous Drain Current	$I_D$	16	A
Pulsed Drain Current(Note1)	$I_{DM}$	64	
Single Pulse Avalanche Energy (Note 2)	$E_{AS}$	900	mJ
Avalanche Current(Note1)	$I_{AR}$	16	A
Repetitive Avalanche Energy (Note1)	$E_{AR}$	30	mJ
Reverse Diode dV/dt (Note 3)	dv/dt	4.5	V/ns
Operating Junction and Storage Temperature Range	$T_J, T_{STG}$	-55 to +150	$^\circ\text{C}$
Maximum lead temperature for soldering purposes, 1/8" from case for 5 seconds	$T_L$	260	$^\circ\text{C}$

### Thermal Characteristics

Parameter	Symbol	TO-220MF	Units
Maximum Junction-to-Case	$R_{thJC}$	3.0	$^\circ\text{C}/\text{W}$
Maximum Power Dissipation	$P_D$	55	W

$T_C=25^\circ\text{C}$

<b>Electrical Characteristics</b> ( $T_c=25^\circ\text{C}$ , unless otherwise noted)						
Parameter	Symbol	Test Conditions	Min	Typ	Max	Units
<b>Off Characteristics</b>						
Drain-Source Breakdown Voltage	$BV_{DSS}$	$V_{GS}=0V, I_D=250\mu A$	650	—	—	V
Breakdown Temperature Coefficient	$\Delta BV_{DSS} / \Delta T_J$	Reference to $25^\circ\text{C}$ , $I_D=250\mu A$	—	0.6	—	$V/^\circ\text{C}$
Zero Gate Voltage Drain Current	$I_{DSS}$	$V_{DS}=650V, V_{GS}=0V$	—	—	1	$\mu A$
Gate-Body Leakage Current, Forward	$I_{GSSF}$	$V_{GS}=30V, V_{DS}=0V$	—	—	100	nA
Gate-Body Leakage Current, Reverse	$I_{GSSR}$	$V_{GS}=-30V, V_{DS}=0V$	—	—	-100	nA
<b>On Characteristics</b>						
Gate-Source Threshold Voltage	$V_{GS(th)}$	$V_{DS}=10V, I_D=250\mu A$	2	—	4	V
Drain-Source On-State Resistance	$R_{DS(on)}$	$V_{GS}=10V, I_D=8A$	—	0.33	0.45	$\Omega$
<b>Dynamic Characteristics</b>						
Input Capacitance	$C_{iss}$	$V_{DS}=25V, V_{GS}=0V,$ $f=1.0\text{MHz}$	—	1968	—	pF
Output Capacitance	$C_{oss}$		—	1047	—	pF
Reverse Transfer Capacitance	$C_{rss}$		—	73	—	pF
<b>Switching Characteristics</b>						
Turn-On Delay Time	$t_{d(on)}$	$V_{DD}=325V, I_D=16A,$ $R_G=25\Omega$ (Note4,5)	—	58	—	ns
Turn-On Rise Time	$t_r$		—	126	—	ns
Turn-Off Delay Time	$t_{d(off)}$		—	214	—	ns
Turn-Off Fall Time	$t_f$		—	49	—	ns
Total Gate Charge	$Q_g$	$V_{DS}=480V, I_D=16A,$ $V_{GS}=10V,$ (Note4,5)	—	63	—	nC
Gate-Source Charge	$Q_{gs}$		—	11	—	nC
Gate-Drain Charge	$Q_{gd}$		—	29	—	nC
<b>Drain-Source Body Diode Characteristics and Maximum Ratings</b>						
Continuous Diode Forward Current	$I_S$		—	—	16	A
Pulsed Diode Forward Current	$I_{SM}$		—	—	64	A
Diode Forward Voltage	$V_{SD}$	$I_S=16A, V_{GS}=0V$	—	—	1.5	V
Reverse Recovery Time	$t_{rr}$	$V_{GS}=0V, I_S=16A,$ $dI_F/dt=100A/\mu s,$ (Note4)	—	483	—	ns
Reverse Recovery Charge	$Q_{rr}$		—	8.9	—	$\mu C$

#### Notes

1. Repetitive Rating: pulse width limited by maximum junction temperature.
2.  $L=10\text{mH}, R_g=25\Omega, I_{AS}=16A$ , starting  $T_J=25^\circ\text{C}$ .
3.  $I_{SD} \leq I_D, dI/dt=200A/\mu s, V_{DD} \leq BV_{DSS}$ , starting  $T_J=25^\circ\text{C}$ .
4. Pulse width  $\leq 300\mu s$ ; duty cycle  $\leq 2\%$ .
5. Repetitive rating; pulse width limited by maximum junction temperature.

## RATING AND CHARACTERISTIC CURVES



Peak Diode Recovery  $dv/dt$  Test Circuit

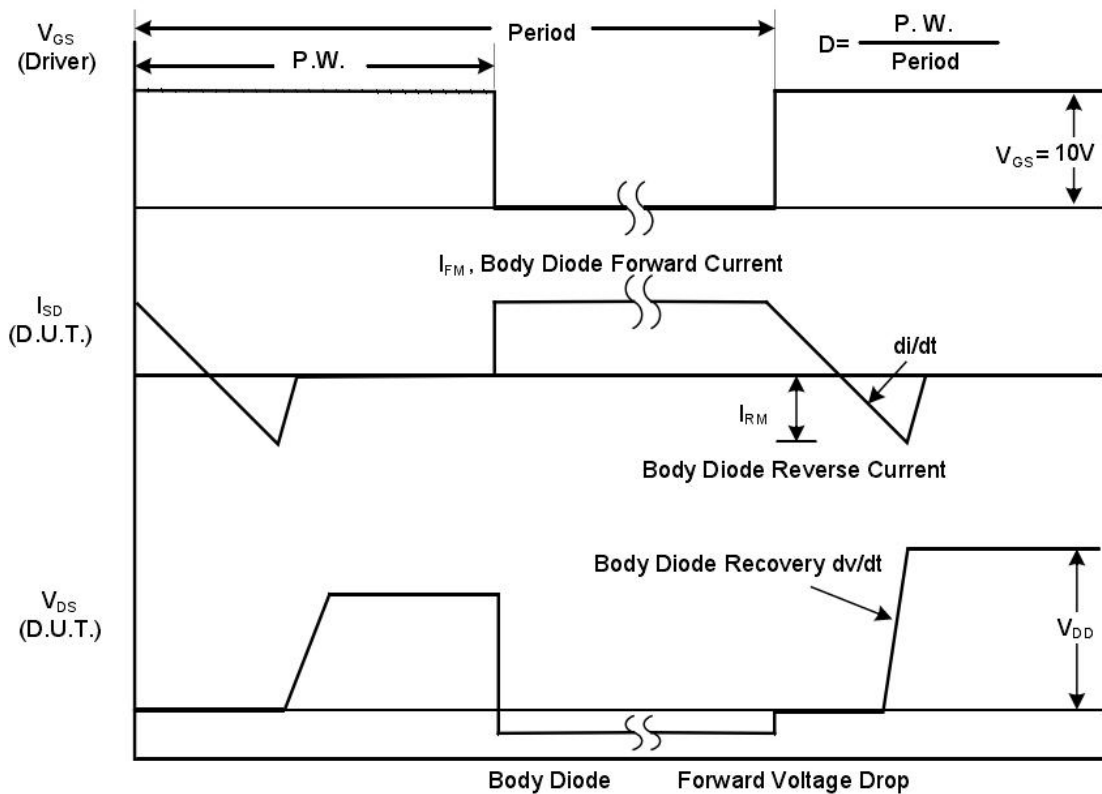

Peak Diode Recovery  $dv/dt$  Waveforms

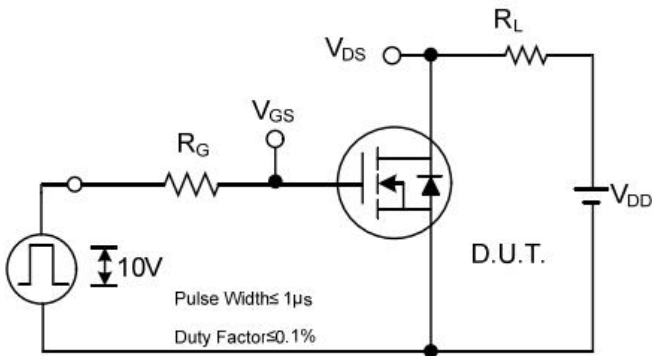

**Switching Test Circuit**

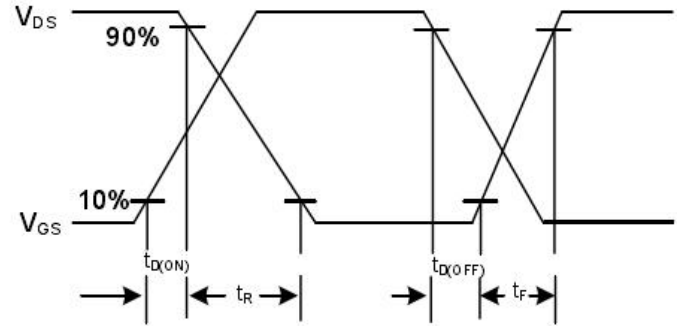

**Switching Waveforms**

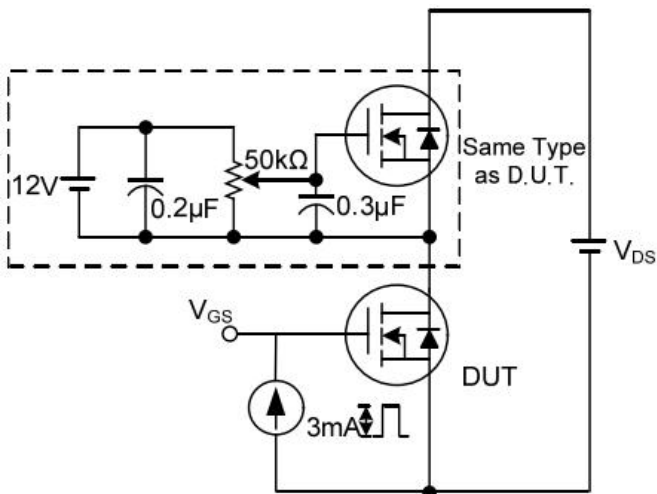

**Gate Charge Test Circuit**

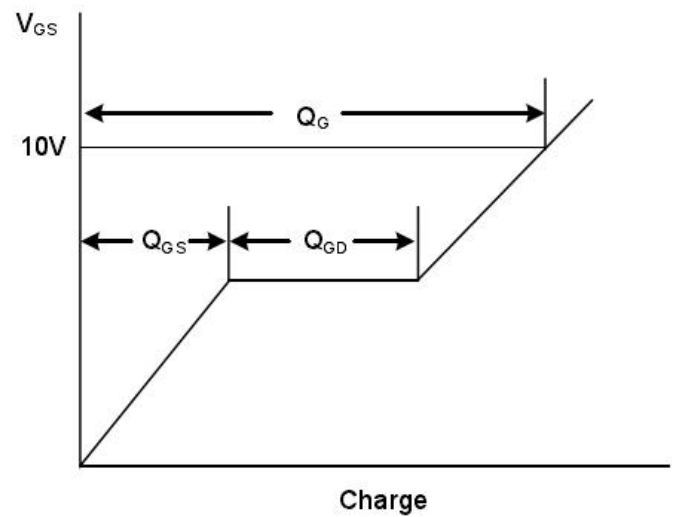

**Gate Charge Waveform**



**Unclamped Inductive Switching Test Circuit**

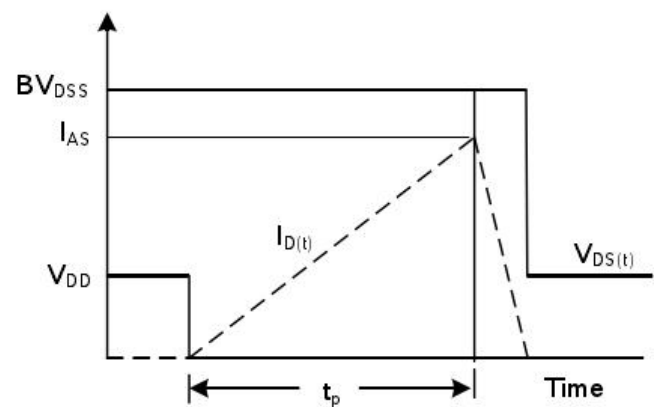

**Unclamped Inductive Switching Waveforms**

## RATING AND CHARACTERISTIC CURVES

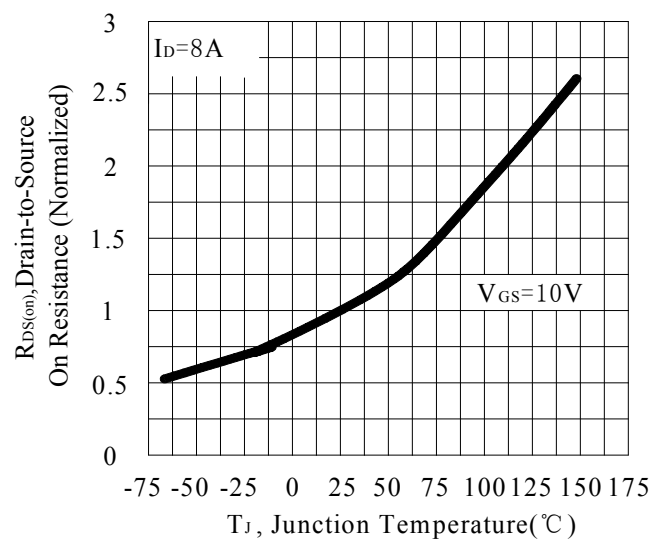
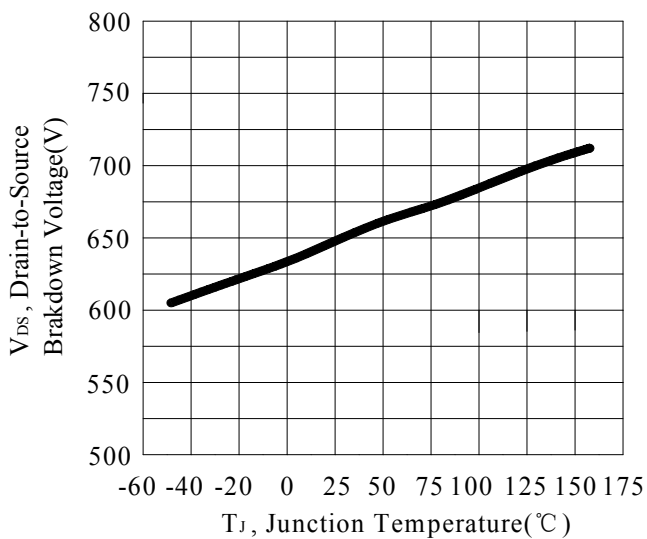
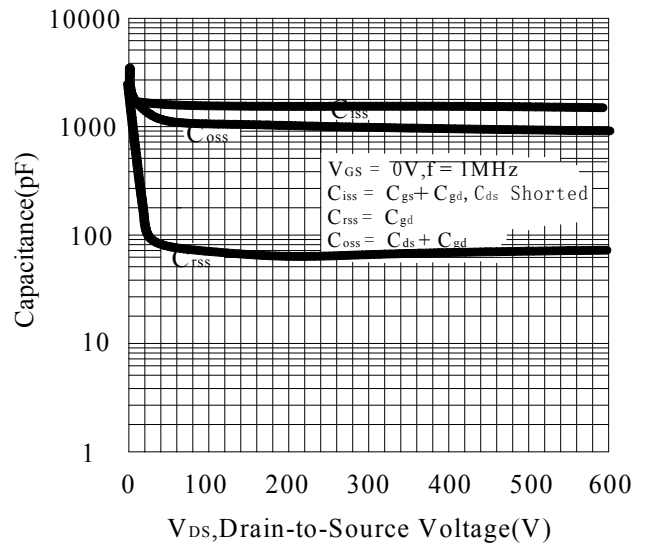
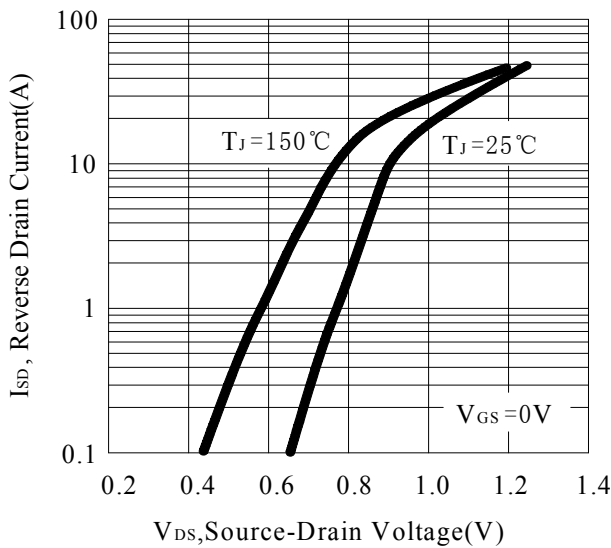
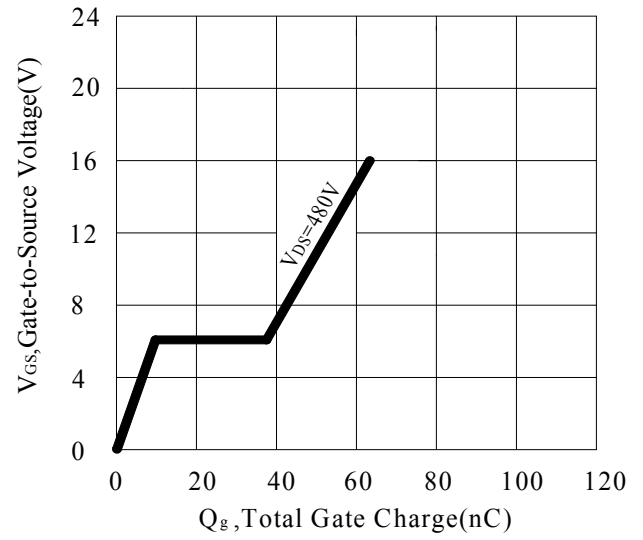
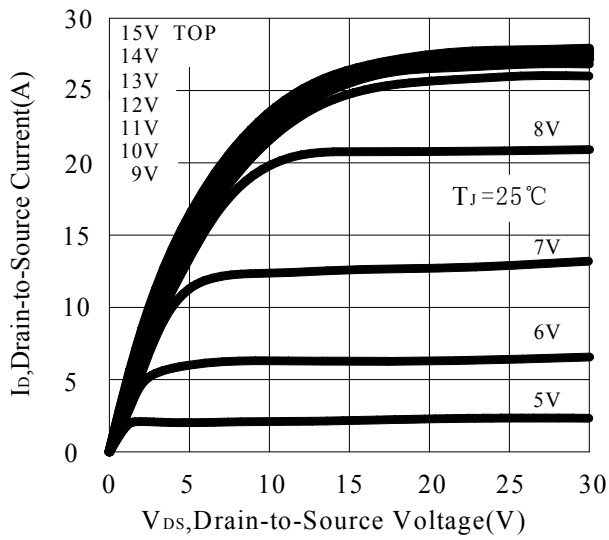

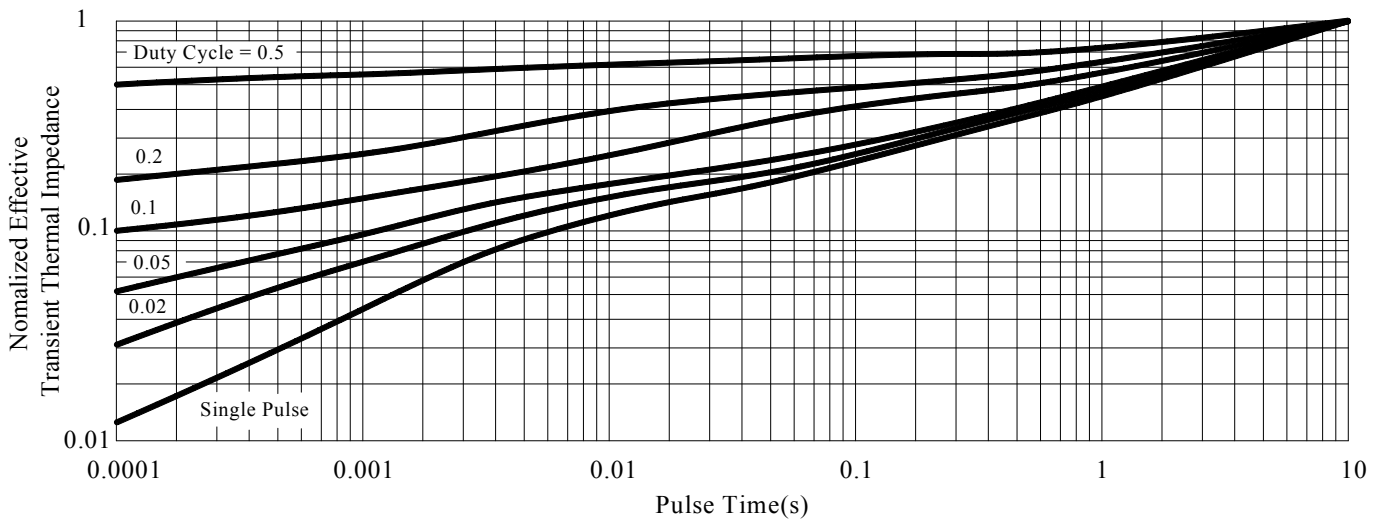
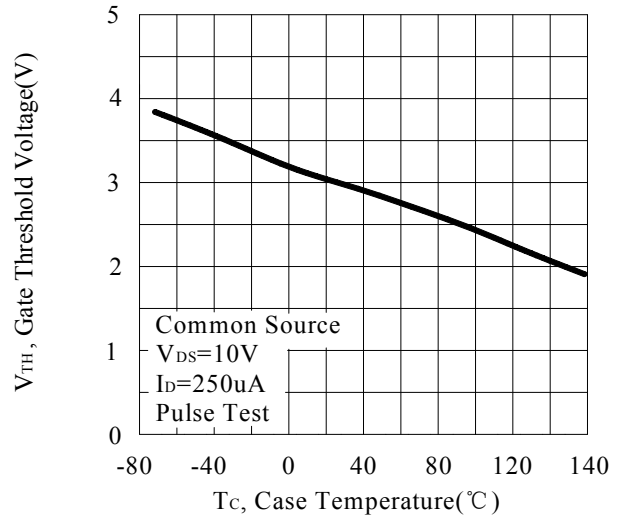
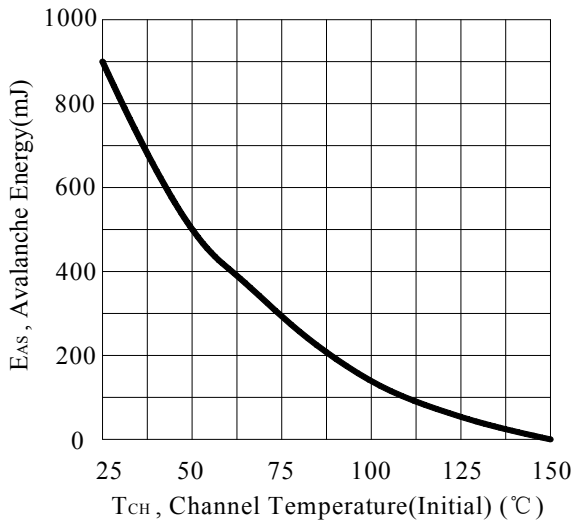
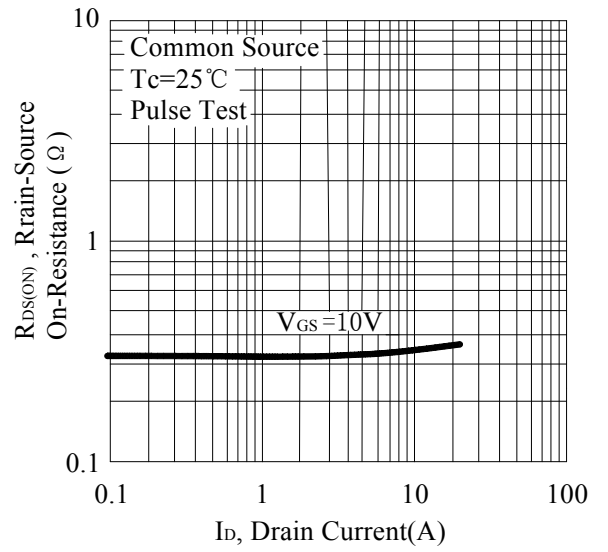
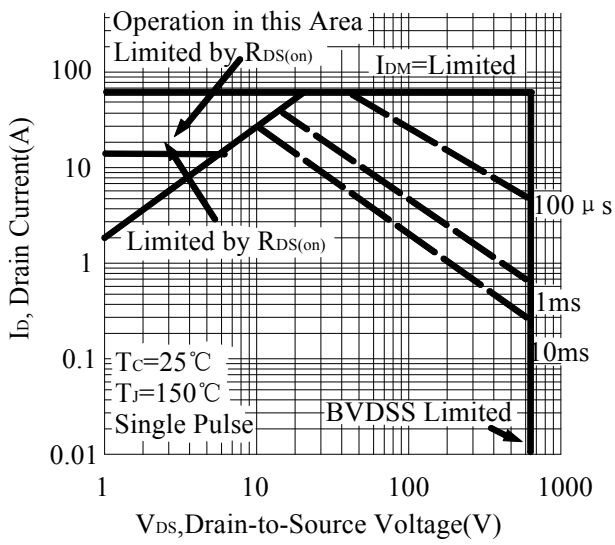

**PACKAGE OUTLINE DIMENSIONS**

**TO-220MF**

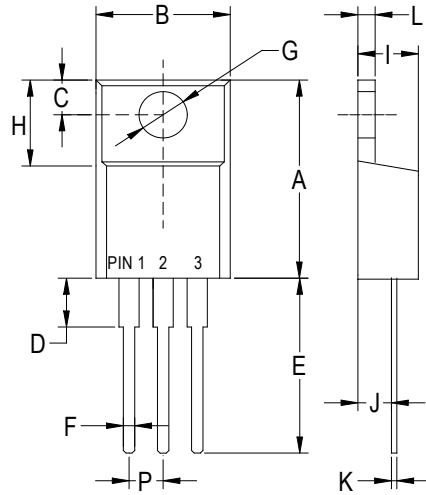

TO-220MF		
Dim	Min	Max
A	.590 (15.0)	.650 (16.5)
B	.393 (10.0)	.414 (10.5)
C	.118 (3.00)	.138 (3.50)
D	.118 (3.00)	.146 (3.70)
E	.512 (13.0)	.551 (14.0)
F	.028 (0.70)	.035 (0.90)
G	.114 (2.90)	.138 (3.50)
H	.255 (6.50)	.280 (7.10)
I	.173 (4.40)	.197 (5.00)
J	.102 (2.60)	.110 (2.80)
K	.018 (0.45)	.026 (0.65)
L	.092 (2.35)	.109 (2.75)
P	.890 (2.25)	.113 (2.85)