

12N60(F,B,H)

12A mps,600 Volts N-CHANNEL MOSFET

FEATURE

- 12A,600V, $R_{DS(ON)}=0.7\Omega @V_{GS}=10V/6A$
- Low gate charge
- Low C_{iss}
- Fast switching
- 100% avalanche tested
- Improved dv/dt capability

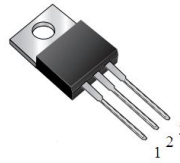
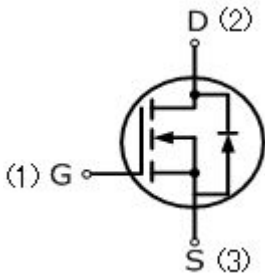

TO-220AB
12N60

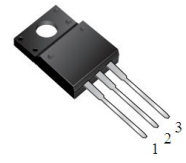

ITO-220AB
12N60F

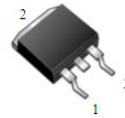

TO-263
12N60B



TO-262
12N60H

Absolute Maximum Ratings ($T_C=25^\circ\text{C}$, unless otherwise noted)

Parameter	Symbol	12N60	UNIT
Drain-Source Voltage	V_{DSS}	600	V
Gate-Source Voltage	V_{GSS}	± 30	
Continuous Drain Current	I_D	12	A
Pulsed Drain Current(Note 1)	I_{DM}	48	
Single Pulse Avalanche Energy (Note 2)	E_{AS}	320	mJ
Avalanche Current(Note 1)	I_{AR}	12	A
Repetitive Avalanche Energy (Note 1)	E_{AR}	33	mJ
Reverse Diode dV/dt (Note 3)	dv/dt	5.5	V/ns
Operating Junction and Storage Temperature Range	T_J, T_{STG}	-55 to +150	$^\circ\text{C}$
Maximum lead temperature for soldering purposes, 1/8" from case for 5 seconds	T_L	260	$^\circ\text{C}$
Mounting Torque	6-32 or M3 screw	10	lbf • in
		1.1	N • m

Thermal Characteristics

Parameter	Symbol	ITO-220	TO-220	TO-262 TO-263	Units
Maximum Junction-to-Case	R_{thJC}	1.0	0.8	0.8	$^\circ\text{C}/\text{W}$
Maximum Power Dissipation	P_D	125	155	155	W

Electrical Characteristics ($T_c=25^\circ\text{C}$, unless otherwise noted)						
Parameter	Symbol	Test Conditions	Mix	Typ	Max	Units
Off Characteristics						
Drain-Source Breakdown Voltage	BV_{DSS}	$V_{GS}=0V, I_D=250\mu\text{A}$	600	—	—	V
Breakdown Temperature Coefficient	$\Delta BV_{DSS} / \Delta T_J$	Reference to 25°C , $I_D=250\mu\text{A}$	—	0.6	—	$\text{V}/^\circ\text{C}$
Zero Gate Voltage Drain Current	I_{DSS}	$V_{DS}=600V, V_{GS}=0V$	—	—	1	μA
Gate-Body Leakage Current, Forward	I_{GSSF}	$V_{GS}=30V, V_{DS}=0V$	—	—	10	μA
Gate-Body Leakage Current, Reverse	I_{GSSR}	$V_{GS}=-30V, V_{DS}=0V$	—	—	-10	μA
On Characteristics						
Gate-Source Threshold Voltage	$V_{GS(th)}$	$V_{DS}=10V, I_D=250\mu\text{A}$	2	—	4	V
Drain-Source On-State Resistance	$R_{DS(on)}$	$V_{GS}=10V, I_D=6A$	—	—	0.7	Ω
Dynamic Characteristics						
Input Capacitance	C_{iss}	$V_{DS}=25V, V_{GS}=0V,$ $f=1.0\text{MHZ}$	—	—	1730	pF
Output Capacitance	C_{oss}		—	—	180	pF
Reverse Transfer Capacitance	C_{rss}		—	—	90	pF
Switching Characteristics						
Turn-On Delay Time	$t_{d(on)}$	$V_{DD}=300V, I_D=12A,$ $R_g=4.7\Omega$ (Note4,5)	—	20	—	ns
Turn-On Rise Time	t_r		—	28	—	ns
Turn-Off Delay Time	$t_{d(off)}$		—	55	—	ns
Turn-Off Fall Time	t_f		—	30	—	ns
Total Gate Charge	Q_g	$V_{DS}=480V, I_D=12A,$ $V_{GS}=10V,$ (Note4,5)	—	58	—	nC
Gate-Source Charge	Q_{gs}		—	14	—	nC
Gate-Drain Charge	Q_{gd}		—	32	—	nC
Drain-Source Body Diode Characteristics and Maximum Ratings						
Continuous Diode Forward Current	I_S		—	—	12	A
Pulsed Diode Forward Current	I_{SM}		—	—	48	A
Diode Forward Voltage	V_{SD}	$I_S=12A, V_{GS}=0V$	—	—	1.5	V
Reverse Recovery Time	t_{rr}	$V_{GS}=0V, I_S=12A,$	—	600	—	ns
Reverse Recovery Charge	Q_{rr}	$dI_F/dt=100A/\mu\text{s},$ (Note4)	—	43	—	μC

Notes

1. Repetitive Rating; pulse width limited by maximum junction temperature.
2. $V_{DD}=50V$, starling, $L=12\text{mH}, R_g=25\Omega, I_{AS}=12A, T_J=25^\circ\text{C}$.
3. $I_{SD} \leq I_D, dI/dt = _A/\mu\text{s}, V_{DD} \leq BV_{DSS}$, starting $T_J=25^\circ\text{C}$.
4. Pulse width $\leq 300\mu\text{s}$; duty cycle $\leq 2\%$.
5. Repetitive rating; pulse width limited by maximum junction temperature.

RATING AND CHARACTERISTIC CURVES

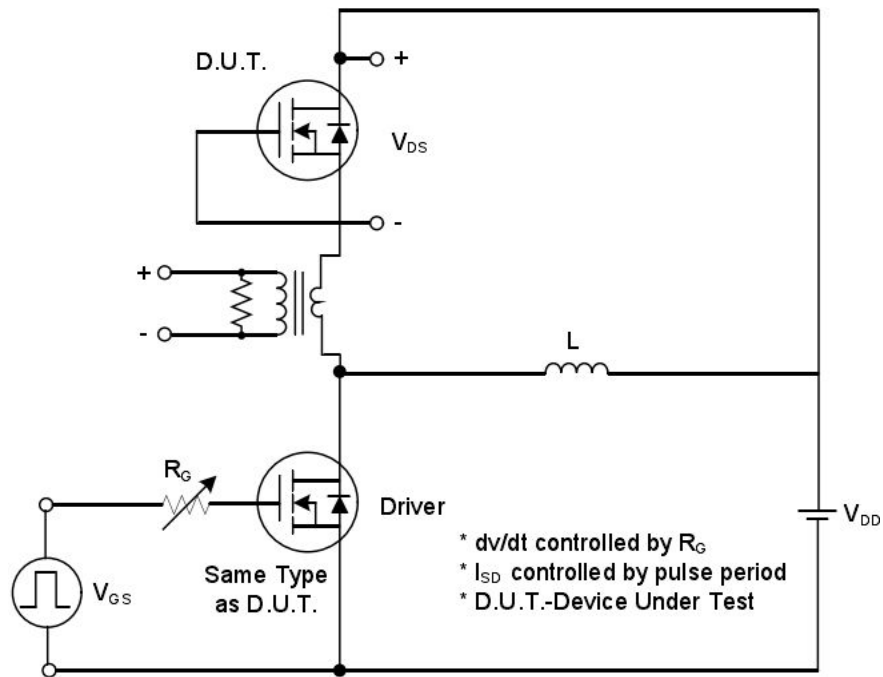

Peak Diode Recovery dv/dt Test Circuit

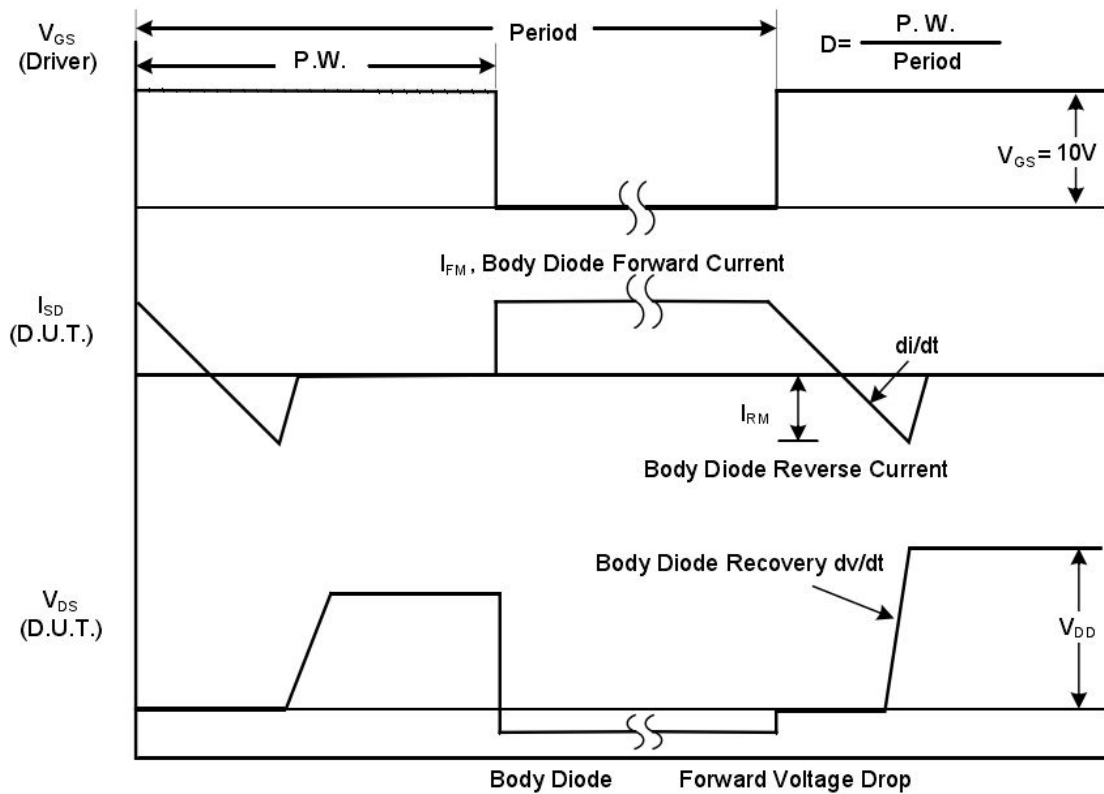

Peak Diode Recovery dv/dt Waveforms

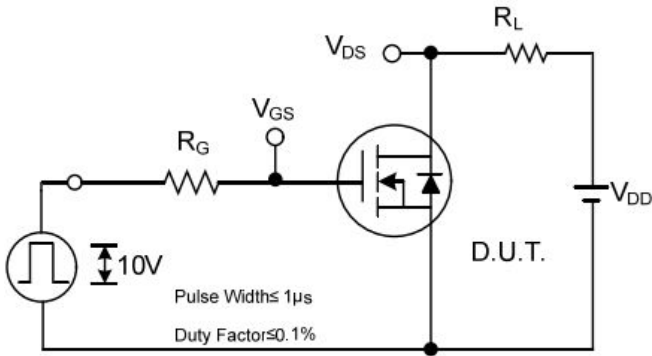

Switching Test Circuit

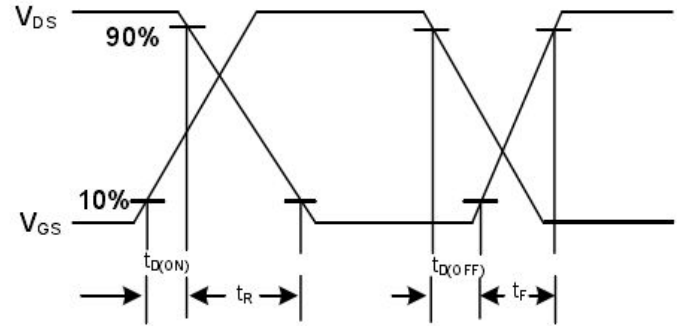

Switching Waveforms

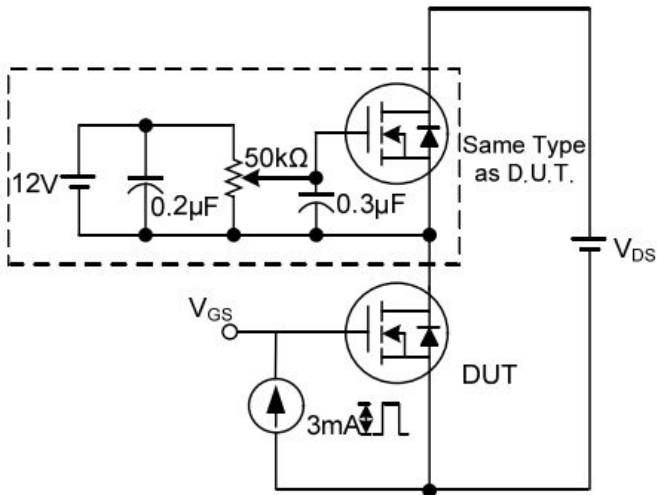

Gate Charge Test Circuit

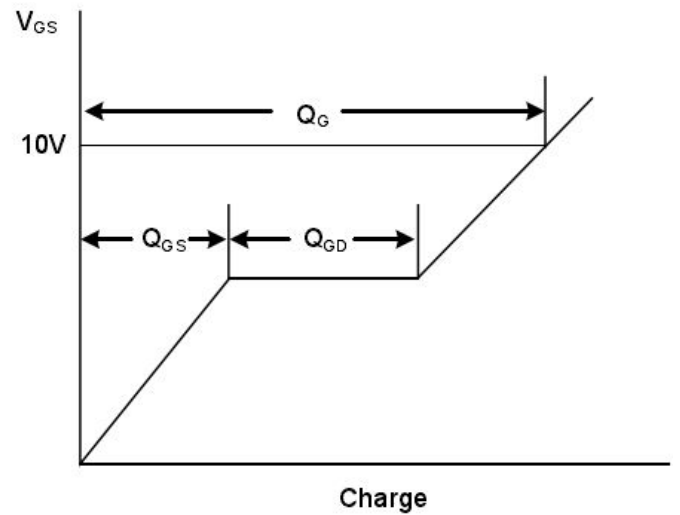

Gate Charge Waveform

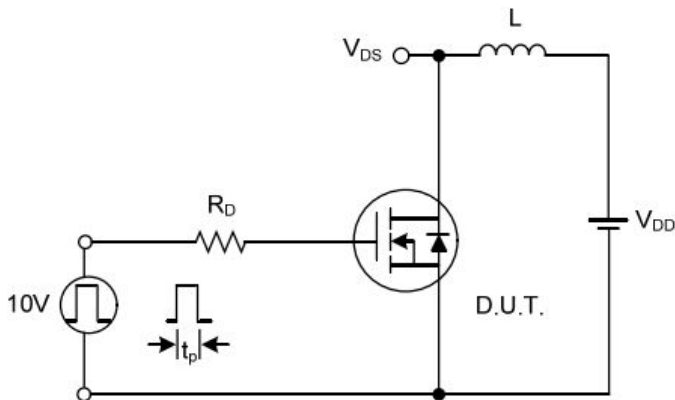

Unclamped Inductive Switching Test Circuit

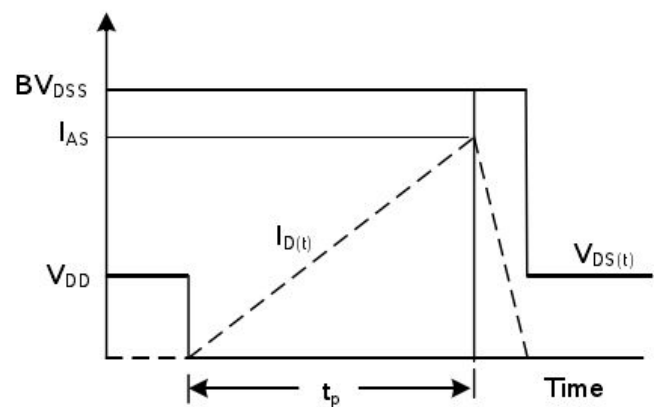

Unclamped Inductive Switching Waveforms

RATING AND CHARACTERISTIC CURVES

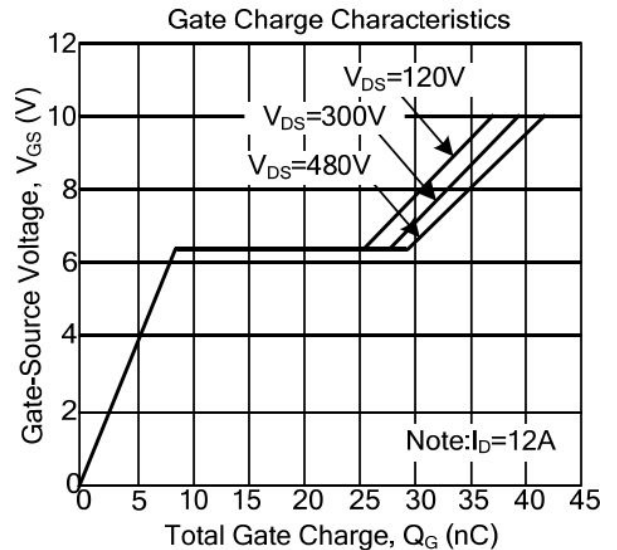
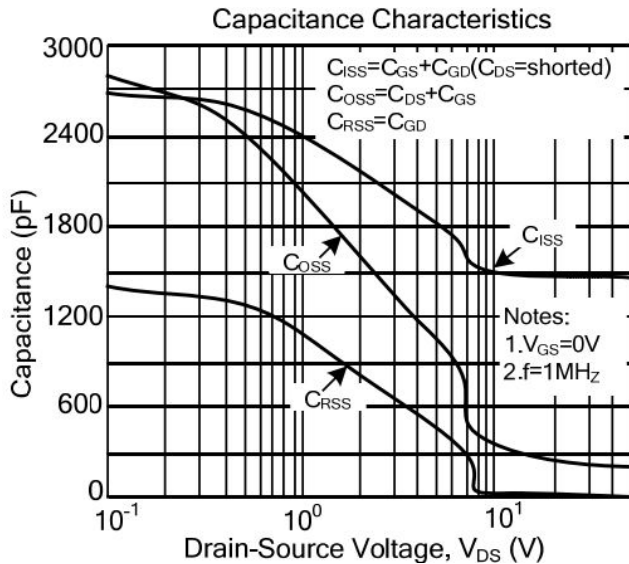
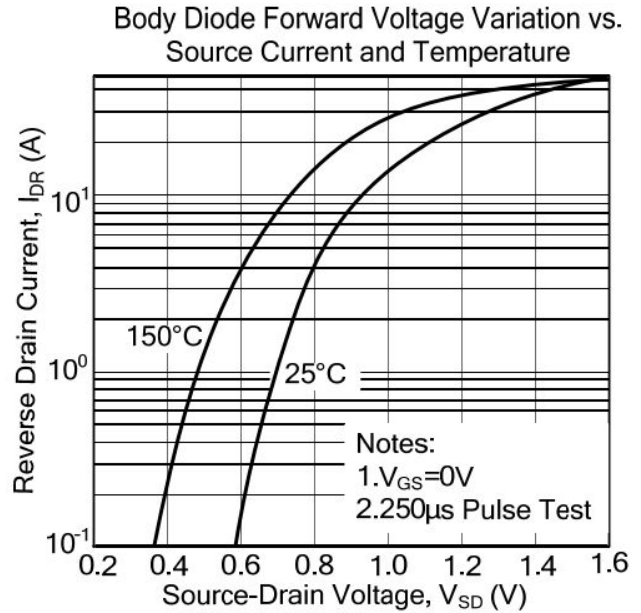
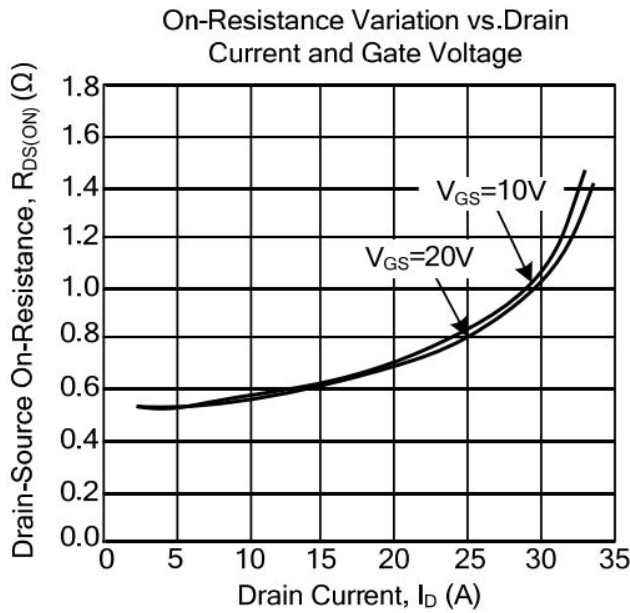
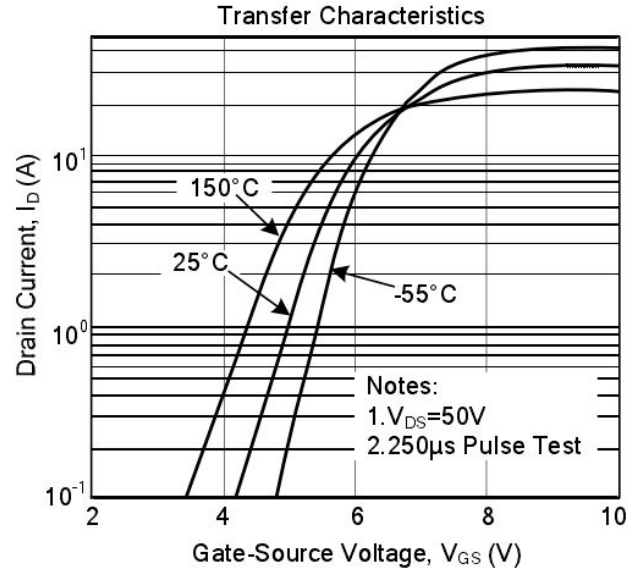
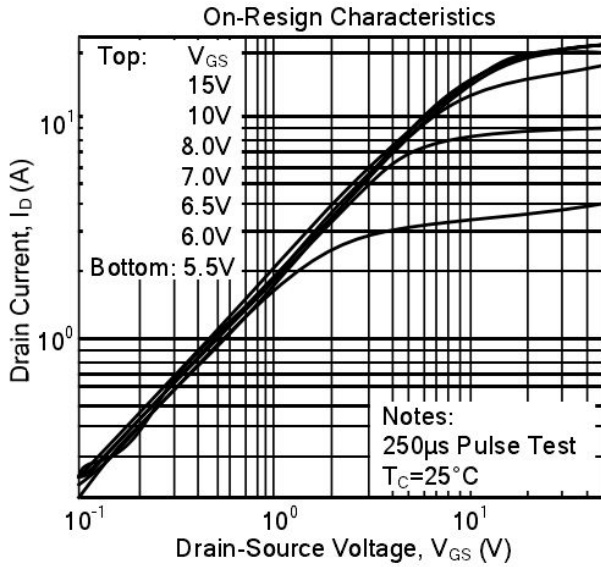

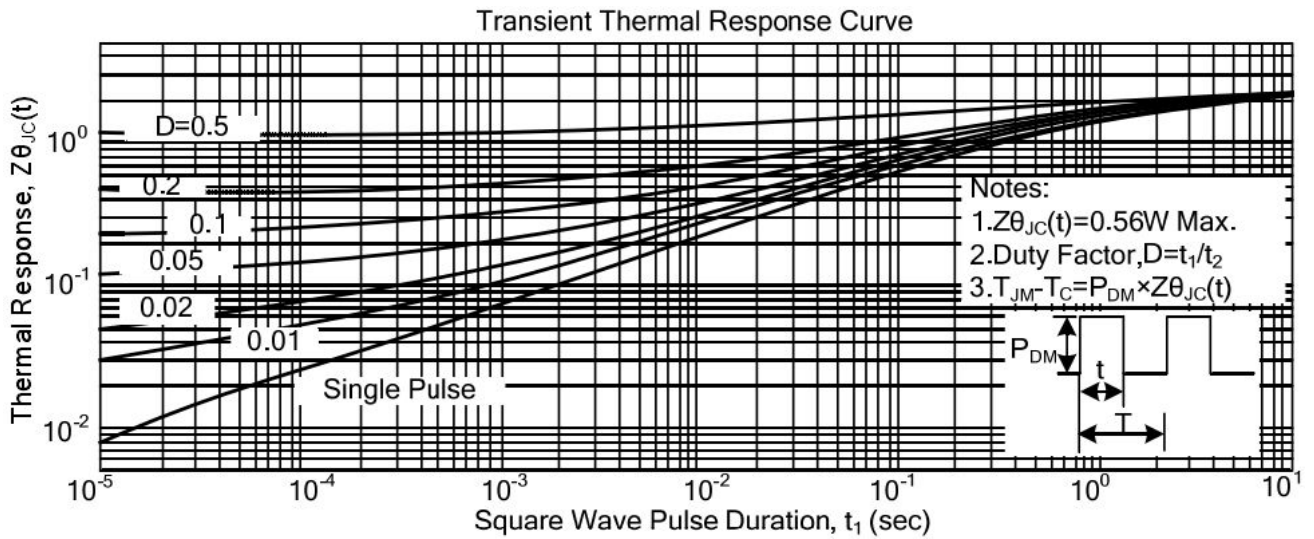
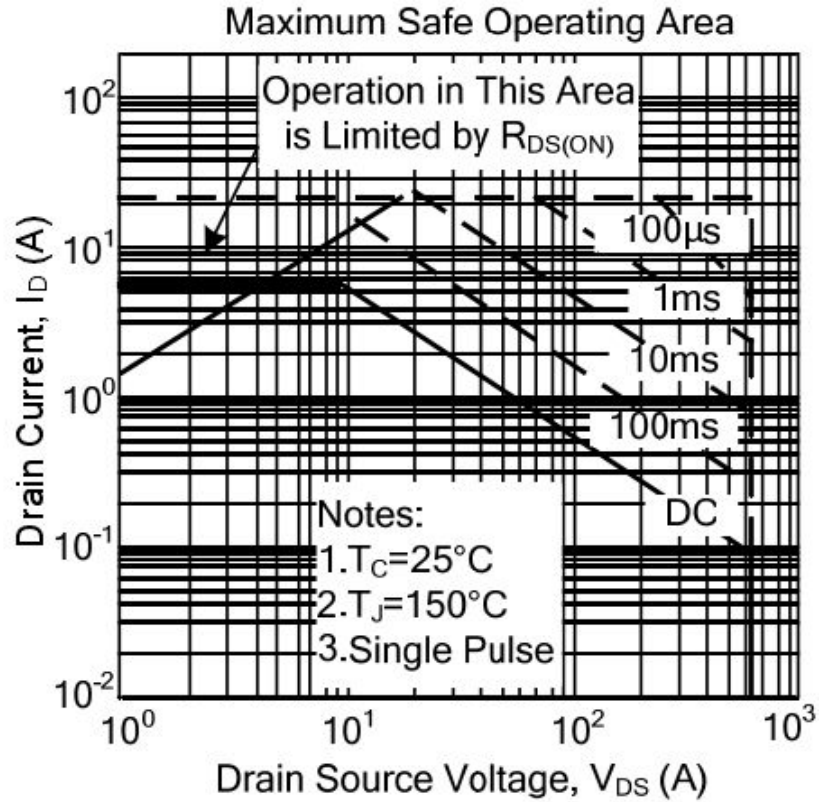

PACKAGE OUTLINE DIMENSIONS

TO-220AB

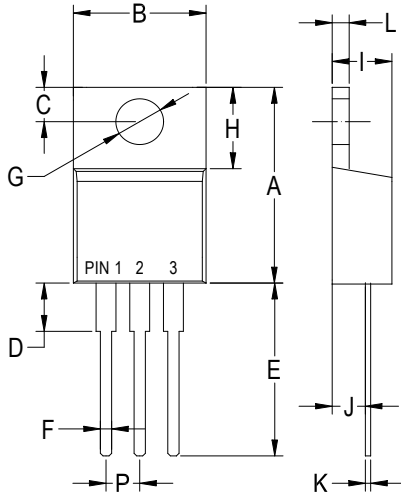

ITO-220AB

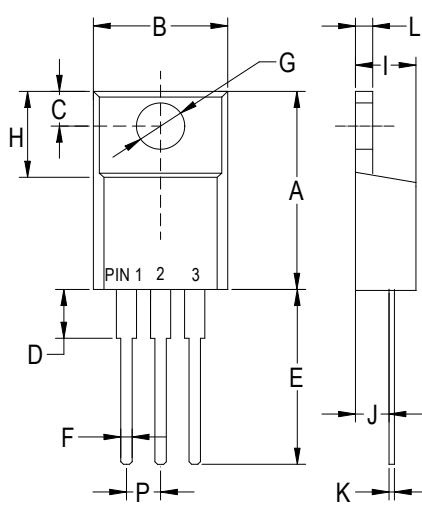

TO-263

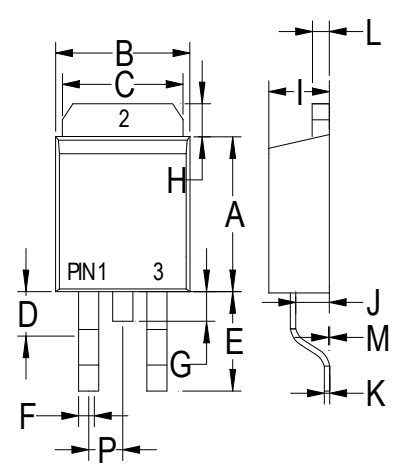

TO-220AB		
Dim	Min	Max
A	.573 (14.55)	.603 (15.32)
B	—	.412 (10.5)
C	.103 (2.62)	.113 (2.87)
D	.140 (3.56)	.160 (4.06)
E	.510 (13.0)	.560 (14.3)
F	.027 (0.68)	.037 (0.94)
G	.148 (3.74)	.154 (3.91)
H	.230 (5.84)	.270 (6.86)
I	.175 (4.44)	.185 (4.86)
J	.100 (2.54)	.110 (2.79)
K	.014 (0.35)	.025 (0.64)
L	.045 (1.14)	.055 (1.40)
P	.095 (2.41)	.105 (2.67)

ITO-220AB		
Dim	Min	Max
A	.571 (14.5)	.610 (15.5)
B	.383 (9.72)	.406 (10.3)
C	.110 (2.80)	.126 (3.20)
D	.133 (3.38)	.162 (4.10)
E	.512 (13.0)	.551 (14.0)
F	.028 (0.70)	.035 (0.90)
G	.114 (2.90)	.138 (3.50)
H	.268 (6.80)	.291 (7.40)
I	.162 (4.10)	.185 (4.70)
J	.102 (2.60)	.110 (2.80)
K	.018 (0.45)	.026 (0.65)
L	.097 (2.46)	.113 (2.86)
P	.890 (2.25)	.113 (2.85)

TO-263		
Dim	Min	Max
A	.323 (8.20)	.348 (8.85)
B	.394 (10.0)	.413 (10.5)
C	.394 (10.0)	.402 (10.2)
D	.077 (1.95)	.100 (2.55)
E	.204 (5.17)	.227 (5.77)
F	.027 (0.68)	.037 (0.94)
G	—	.067 (1.70)
H	.046 (1.17)	.053 (1.34)
I	.175 (4.44)	.191 (4.86)
J	.100 (2.54)	.110 (2.79)
K	.014 (0.35)	.025 (0.64)
L	.047 (1.20)	.055 (1.40)
M	.000 (0.00)	.010 (0.25)
P	.095 (2.41)	.105 (2.67)

Dimensions in inches and (millimeters)