

Features

- ◆ Low On-Resistance
- ◆ Fast Switching
- ◆ 100% Avalanche Tested
- ◆ Repetitive Avalanche Allowed up to T_{jmax}
- ◆ Lead-Free, RoHS Compliant

Description

VS4020AS designed by the trench processing techniques to achieve extremely low on-resistance. Additional features of this design are a 150°C junction operating temperature, fast switching speed and improved repetitive avalanche rating. These features combine to make this design an extremely efficient and reliable device for use in Motor applications and a wide variety of other applications.

V_{DS}	40	V
$R_{DS(on),TYP} @ V_{GS}=10\text{ V}$	6.0	m Ω
$R_{DS(on),TYP} @ V_{GS}=4.5\text{ V}$	7.5	m Ω
I_D	18	A

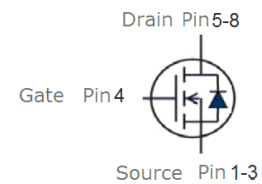
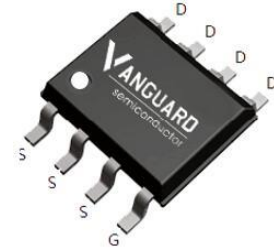

Absolute Maximum Ratings

Stresses beyond those listed under "Absolute Maximum Ratings" may cause permanent damage to the device. These are stress ratings only; and functional operation of the device at these or any other condition beyond those indicated in the specifications is not implied. Exposure to absolute-maximum-rated conditions for extended periods may affect device reliability. The thermal resistance and power dissipation ratings are measured under board mounted and still air conditions. Ambient temperature (T_A) is 25°C, unless otherwise specified.

Symbol	Parameter	Rating	Unit
Common Ratings ($T_c=25^\circ\text{C}$ Unless Otherwise Noted)			
V_{GS}	Gate-Source Voltage	± 20	V
$V_{(BR)DSS}$	Drain-Source Breakdown Voltage	40	V
ESD	Human Body Mode	± 800	V
T_J	Maximum Junction Temperature	150	$^\circ\text{C}$
T_{STG}	Storage Temperature Range	-55 to 150	$^\circ\text{C}$
I_S	Diode Continuous Forward Current	$T_C = 25^\circ\text{C}$ 2.6	A
EAS	Avalanche energy, single pulsed ②	58	mJ
Mounted on Large Heat Sink			
I_{DM}	Pulse Drain Current Tested (Silicon Limit) ①	$T_C = 25^\circ\text{C}$ 72	A
I_D	Continuous Drain current @ $V_{GS}=10\text{V}$	$T_C = 25^\circ\text{C}$ 18	A
P_D	Maximum Power Dissipation	$T_C = 25^\circ\text{C}$ 3.1	W
		$T_C = 75^\circ\text{C}$ 1.9	W
$R_{\theta JA}$	Thermal Resistance-Junction to Ambient	40	$^\circ\text{C/W}$

Typical Electrical Characteristics

Symbol	Parameter	Condition	Min.	Typ.	Max.	Unit
Static Electrical Characteristics @ T_J = 25°C (unless otherwise stated)						
V _{(BR)DSS}	Drain-Source Breakdown Voltage	V _{GS} =0V, I _D =250μA	40	--	--	V
I _{DSS}	Zero Gate Voltage Drain Current(T _J =25°C)	V _{DS} =32V, V _{GS} =0V	--	--	1	μA
	Zero Gate Voltage Drain Current(T _J =125°C)	V _{DS} =32V, V _{GS} =0V	--	--	100	μA
I _{GSS}	Gate-Body Leakage Current	V _{GS} =±20V, V _{DS} =0V	--	--	±100	nA
V _{GS(TH)}	Gate Threshold Voltage	V _{DS} =V _{GS} , I _D =250μA	1.0	2.0	2.5	V
R _{DS(ON)}	Drain-Source On-State Resistance ^③	V _{GS} =10V, I _D =10A	--	6.0	7.5	mΩ
R _{DS(ON)}	Drain-Source On-State Resistance ^③	V _{GS} =4.5V, I _D =6A	--	7.5	8.5	mΩ
Dynamic Electrical Characteristics @ T_J = 25°C (unless otherwise stated)						
C _{iss}	Input Capacitance	V _{DS} =20V, V _{GS} =0V, f=1MHz	--	2250	--	pF
C _{oss}	Output Capacitance		--	320	--	pF
C _{rss}	Reverse Transfer Capacitance		--	195	--	pF
Q _g	Total Gate Charge	V _{GS} =10V	--	42	--	nC
		V _{GS} =4.5V	--	25	--	nC
Q _{gs}	Gate-Source Charge	V _{DS} =20V, I _D =10A, V _{GS} =10V	--	7	--	nC
Q _{gd}	Gate-Drain Charge		--	9.5	--	nC
Switching Characteristics						
t _{d(on)}	Turn-on Delay Time	V _{DD} =20V, I _D =9A, R _G =6.8Ω, V _{GS} =10V	--	16.5	--	nS
t _r	Turn-on Rise Time		--	17.5	--	nS
t _{d(off)}	Turn-Off Delay Time		--	24	--	nS
t _f	Turn-Off Fall Time		--	16	--	nS
Source- Drain Diode Characteristics @ T_J = 25°C (unless otherwise stated)						
V _{SD}	Forward on voltage	I _{SD} =10A, V _{GS} =0V	--	--	1.2	V
t _{rr}	Reverse Recovery Time	T _J =25°C, I _{SD} =9A, V _{GS} =0V	--	28	--	nS
Q _{rr}	Reverse Recovery Charge	di/dt=100A/μs	--	16	--	nC

NOTE:

- ① Repetitive rating; pulse width limited by max. junction temperature.
- ② Limited by T_{Jmax}, starting T_J = 25°C, L = 0.5mH, R_G = 25Ω, I_{AS} = 12A, V_{GS} = 10V. Part not recommended for use above this value
- ③ Pulse width ≤ 300μs; duty cycles ≤ 2%.

Typical Characteristics

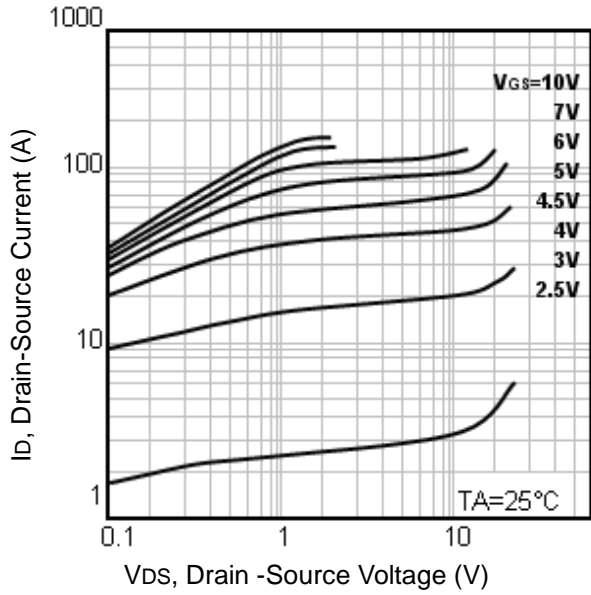

Fig1. Typical Output Characteristics

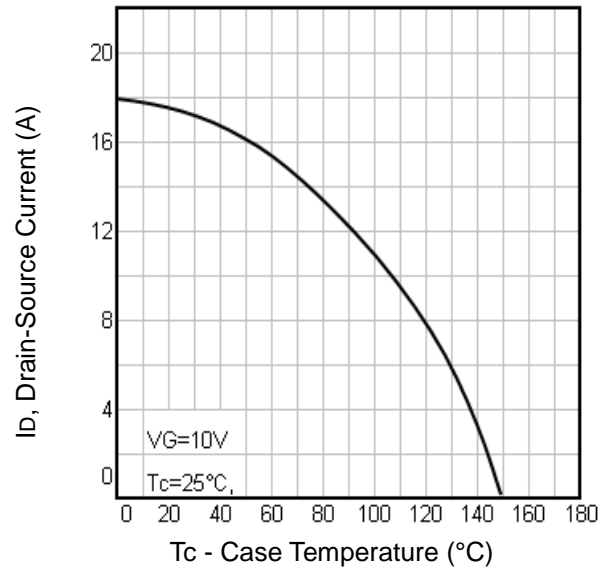

Fig2. Maximum Drain Current Vs. Case Temperature

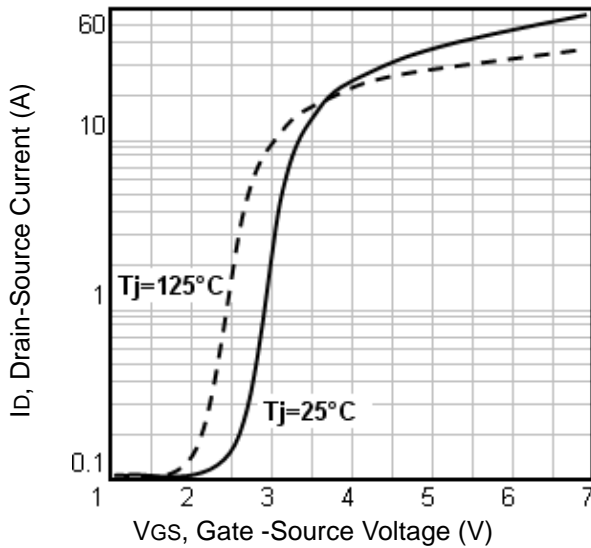

Fig3. Typical Transfer Characteristics

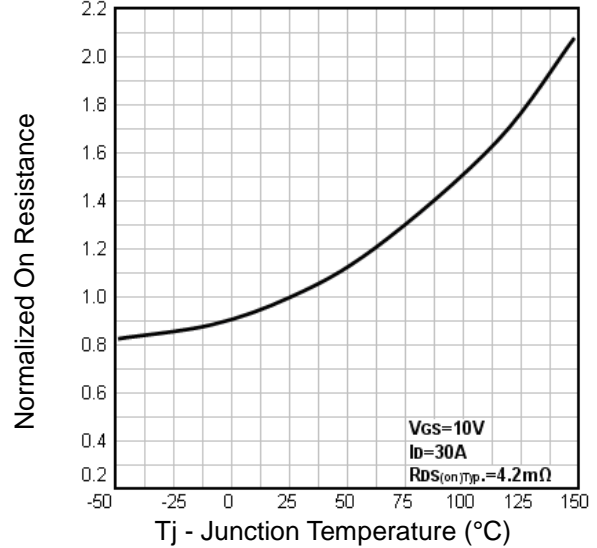

Fig4. Normalized On-Resistance Vs. Temperature

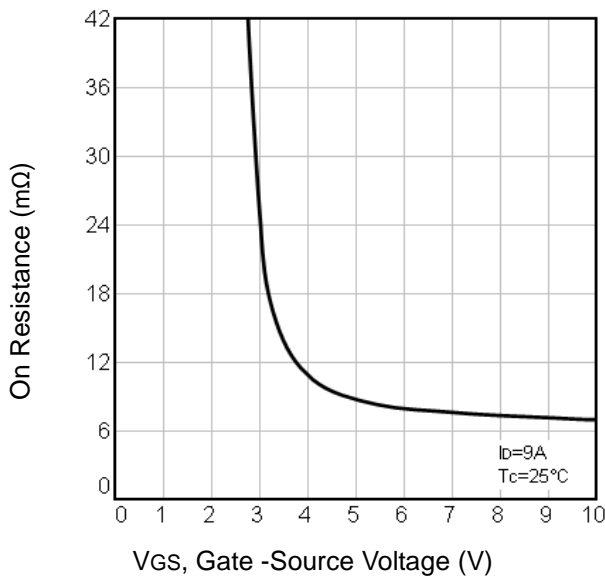

Fig5. On Resistance Vs. Gate-Source Voltage

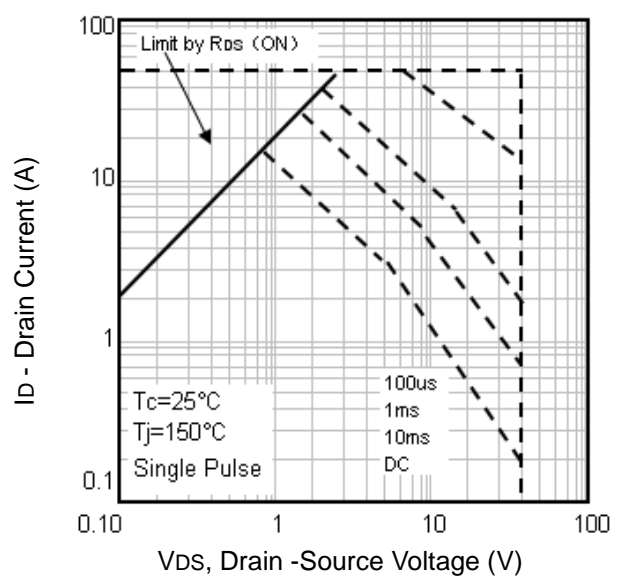

Fig6. Maximum Safe Operating Area

Typical Characteristics

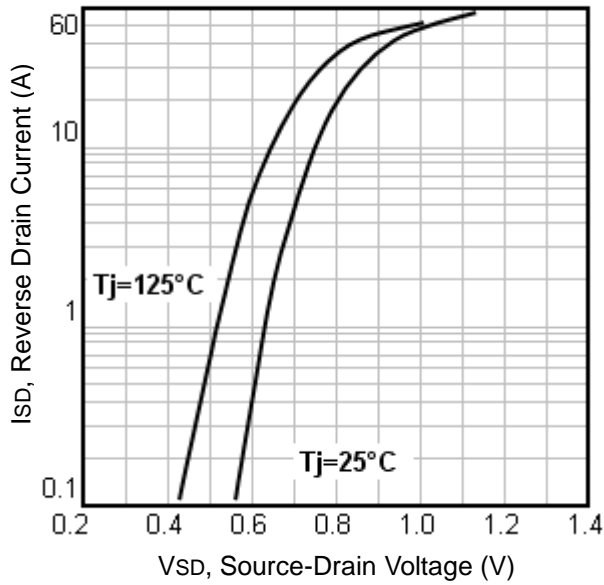

Fig7. Typical Source-Drain Diode Forward Voltage

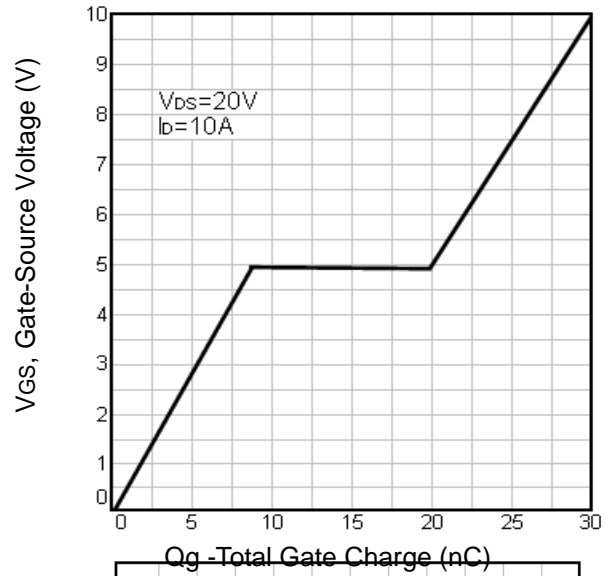

Fig8. Typical Gate Charge Vs. Gate-Source Voltage

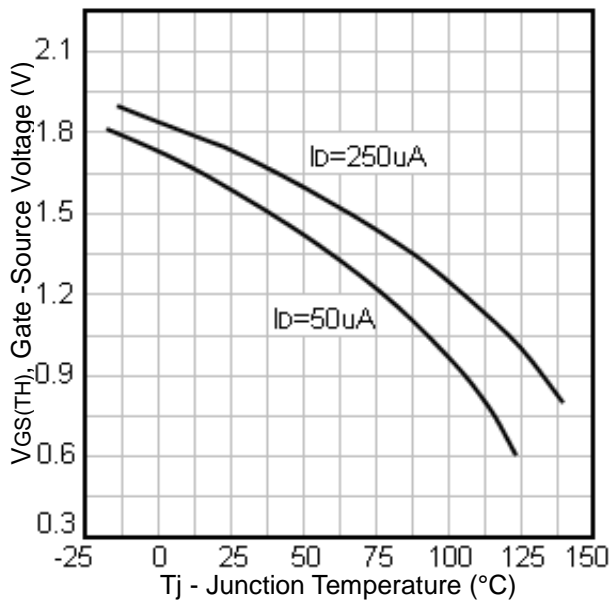

Fig9. Threshold Voltage Vs. Temperature

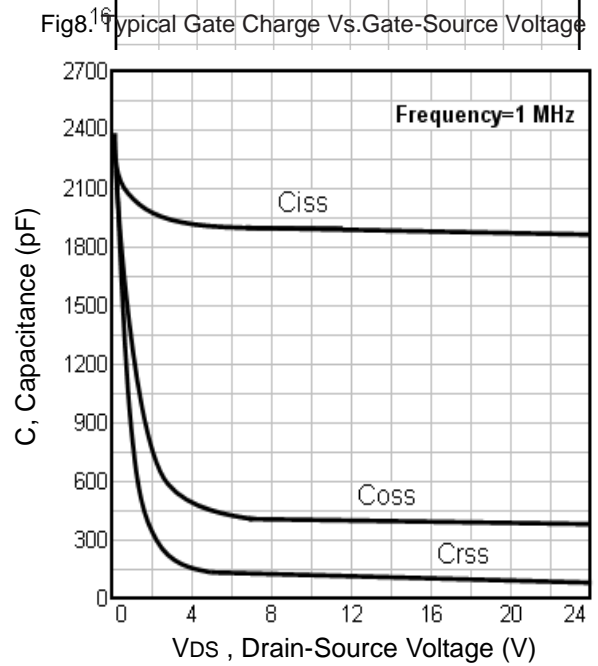

Fig10. Typical Capacitance Vs. Drain-Source Voltage

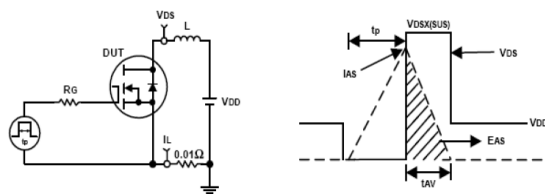

Fig11. Unclamped Inductive Test Circuit and waveforms

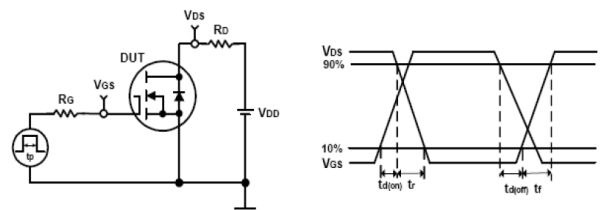
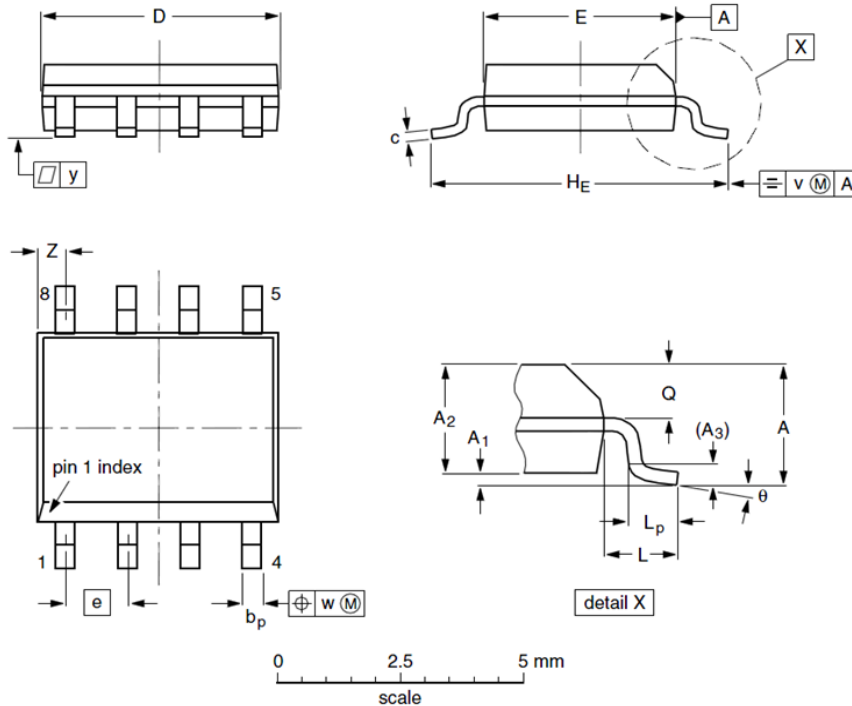

Fig12. Switching Time Test Circuit and waveforms

SOP8 Package Outline Data



Label	Dimensions (unit: mm)		
	Min	Typ	Max
A	--	--	1.75
A ₁	0.10	0.18	0.25
A ₂	1.25	1.35	1.50
A ₃	--	0.25	--
b _p	0.36	0.42	0.51
c	0.19	0.22	0.25
D	4.80	4.92	5.00
E	3.80	3.90	4.00
e	--	1.27	--
H _E	5.80	6.00	6.20
L	--	1.05	--
L _p	0.40	0.68	1.00
Q	0.60	0.65	0.725
v	--	0.25	--
w	--	0.25	--
y	--	0.10	--
Z	0.30	0.50	0.70
θ	0°		8°

Notes:

1. Follow JEDEC MS-012.
2. Dimension "D" does NOT include mold flash, protrusions or gate burrs. Mold flash, protrusions or gate burrs shall not exceed 0.15mm per side.
3. Dimension "E" does NOT include interlead flash or protrusion. Interlead flash or protrusion shall not exceed 0.25mm per side.
4. Dimension "b_p" does NOT include dambar protrusion. Allowable dambar protrusion shall be 0.1mm total in excess of "b_p" dimension at maximum material condition. The dambar cannot be located on the lower radius of the foot.

Customer Service

Sales and Service:

sales@vgsemi.com

Vanguard Semiconductor CO., LTD

TEL: (86-755) -26902410

FAX: (86-755) -26907027

WEB: www.vgsemi.com