



MMBT8050-1.5A

NPN Transistor

Features

- For Switching and Amplifier Applications.
- Especially Suitable for AF-Driver Stages and Low Power Output Stages.

SOT-23
(TO-236)

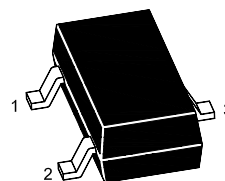

1.Base 2.Emitter 3.Collector

Marking: -C: X1

-D: Y1

Absolute Maximum Ratings

Ratings at 25°C ambient temperature unless otherwise specified.

Parameter	Symbol	Value	Unit
Collector Base Voltage	V_{CB0}	40	V
Collector Emitter Voltage	V_{CEO}	25	V
Emitter Base Voltage	V_{EBO}	6	V
Collector Current	I_C	1.5	A
Power Dissipation	P_D	350	mW
Junction Temperature	T_J	150	°C
Storage Temperature Range	T_{STG}	-55 to 150	°C

Electrical Characteristics

Ratings at 25°C ambient temperature unless otherwise specified.

Parameter	Symbol	Min.	Typ.	Max.	Unit
DC Current Gain at $V_{CE} = 1\text{ V}$, $I_C = 100\text{ mA}$ Current Gain Group	C D H_{FE}	100	-	250	
		160	-	400	
		at $V_{CE} = 1\text{ V}$, $I_C = 800\text{ mA}$	40	-	
Collector Base Cutoff Current at $V_{CB} = 35\text{ V}$	I_{CB0}	-	-	100	nA
Emitter Base Cutoff Current at $V_{CB} = 6\text{ V}$	I_{EBO}	-	-	100	nA
Collector Base Breakdown Voltage at $I_C = 100\text{ }\mu\text{A}$	$V_{(BR)CB0}$	40	-	-	V
Collector Emitter Breakdown Voltage at $I_C = 2\text{ mA}$	$V_{(BR)CEO}$	25	-	-	V
Emitter Base Breakdown Voltage at $I_E = 100\text{ }\mu\text{A}$	$V_{(BR)EBO}$	6	-	-	V
Collector Emitter Saturation Voltage at $I_C = 800\text{ mA}$, $I_B = 80\text{ mA}$	$V_{CE(sat)}$	-	-	0.5	V
Base Emitter Saturation Voltage at $I_C = 800\text{ mA}$, $I_C = 80\text{ mA}$	$V_{BE(sat)}$	-	-	1.2	V
Base Emitter Voltage at $V_{CE} = 1\text{ V}$, $I_B = 10\text{ mA}$	$V_{BE(on)}$	-	-	1	V
Transition Frequency at $V_{CE} = 10\text{ V}$, $I_C = 50\text{ mA}$	F_T	120	-	-	MHz



Electrical Characteristics Curves

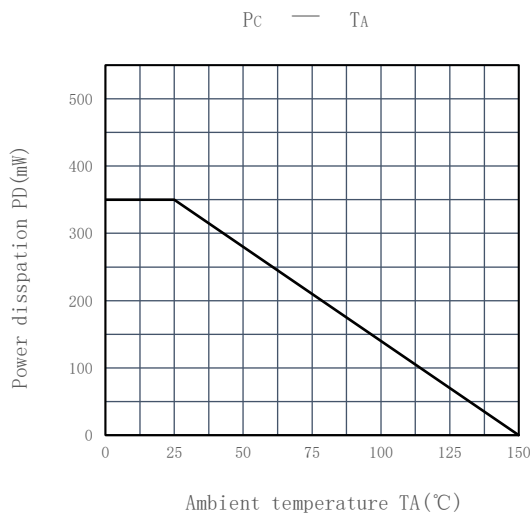
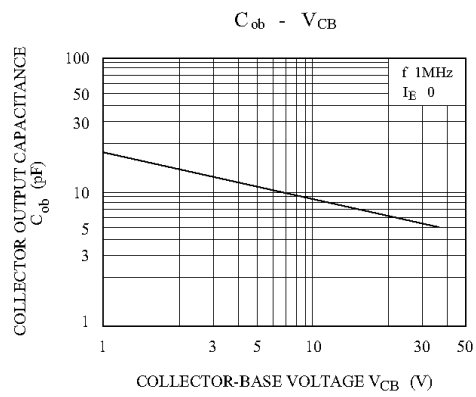
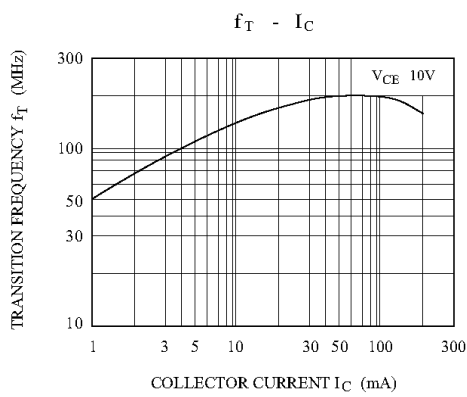
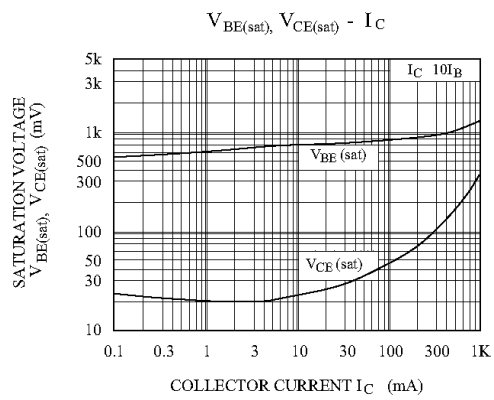
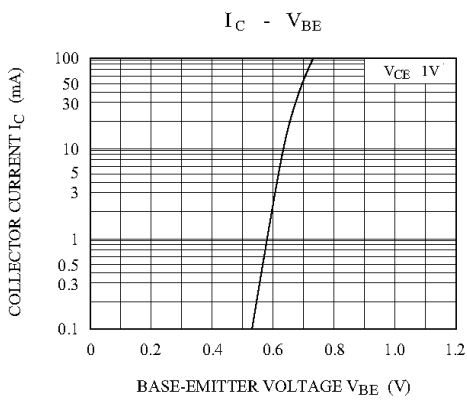
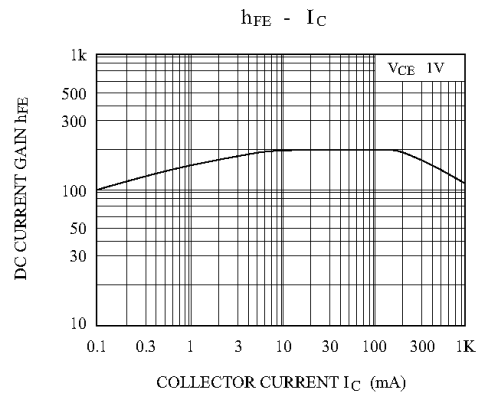
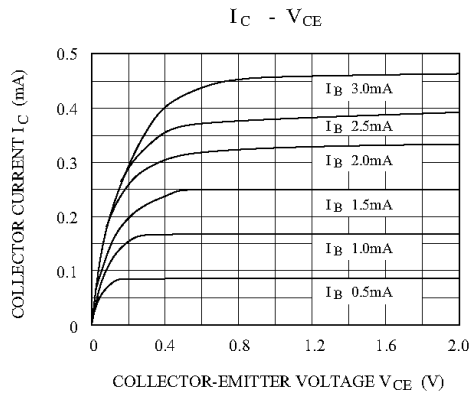



Package Outline(SOT-23)

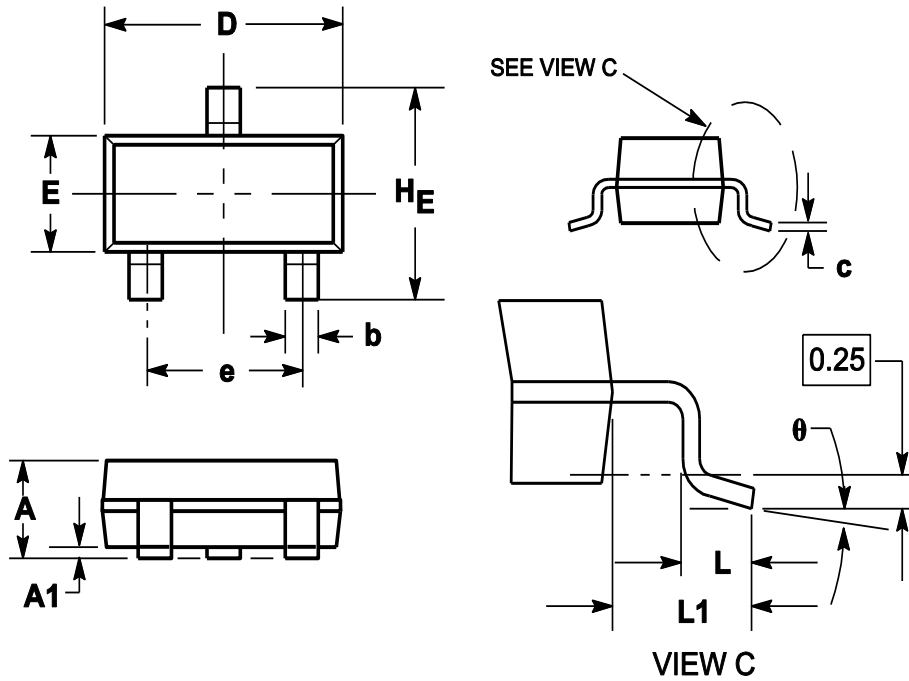

Symbol	Dimensions in millimeter		
	Min.	Typ.	Max.
A	0.900	1.025	1.150
A1	0.000	0.050	0.100
b	0.300	0.400	0.500
c	0.080	0.115	0.150
D	2.800	2.900	3.000
E	1.200	1.300	1.400
HE	2.250	2.400	2.550
e	1.800	1.900	2.000
L1	0.550REF		
L	0.300		0.500
θ	0°		8°

Ordering Information

Device	Package	Reel Dimension (inch)	Shipping
MMBT8050-1.5A	SOT-23	7	3,000