

# Negative Temperature Coefficient Thermistor (NTC)

## Data Sheet

### Feature

■ Wide operating voltage range from  $\phi 5$  to  $\phi 20$

■ Operating Temperature



Style	Operating Temperature Range
$\phi 5$	$-40^{\circ}\text{C} \sim 155^{\circ}\text{C}$
$\phi 7 / \phi 9 / \phi 11$	$-40^{\circ}\text{C} \sim 175^{\circ}\text{C}$
$\phi 13 / \phi 15 / \phi 20$	$-40^{\circ}\text{C} \sim 200^{\circ}\text{C}$

■ Storage Temperature:  $15^{\circ}\text{C} \sim 35^{\circ}\text{C}$

### Applications

■ Suitable for power supply, electronic motors, transformers, adapters, projectors, halogen machines, LED drive circuits, etc.

### Applicable Standard

Approval	Organization	Safety Standards	Certificate No.
China 	CQC	GB/T 6663.1	CQC15001128226
USA Canada 	UL	UL 1434	E474052

## Part Number Code

MF	05	100	X8	M	3	B	X7	C	S	B	0
----	----	-----	----	---	---	---	----	---	---	---	---

**Songtian**  
MF:NTC

**Zero Power Resistance**

0R5:0.5Ω  
080:8Ω  
100:10Ω  
121:120Ω

**Tolerance**

M:±20%

**Pitch**

B:5.0mm  
E:7.5mm  
D:10.0mm

**Package**

B: Bulk  
T: Tape

**Inner Management**

**Encapsulation material**  
**Environmental Standard**

S:Silicone+RoHS  
P:Phenolic Resin+RoHS  
F:Phenolic Resin +Halogen free  
R:Phenolic Resin + Halogen free

**Core Diameter**

05:5mm  
20:20mm

**Foot Type**

1:Long straight  
2:Outside Crimped  
3:Short Straight  
4:Inside kink lead  
8:Vertical Crimped

**Lead Material**

F: Tinned copper clad steel wire  
C:Copper wire

**Maximum Steady State Current**

X1:0.1A  
S5:1.5A  
03:3.0A  
10:10A

**Lead Length**

S0~S9:1.0~1.9mm  
X0~X9:2.0~2.9mm  
A0~A9:3.0~3.9mm  
B0~B9:4.0~4.9mm  
C0~C9:5.0~5.9mm  
D0~D9:6.0~6.9mm  
E0~E9:7.0~7.9mm

**Lead Length**

F0~F9:8.0~8.9mm  
G0~G9:9.0~9.9mm  
H0~H9:10.0~10.9mm  
J0~J9:11.0~11.9mm  
K0~K9:12.0~12.9mm  
L0~L9:13.0~13.9mm  
M0~M9:14.0~14.9mm

**Lead Length**

M0~M9:14.0~14.9mm  
N0:16~27.0mm(Bulk)  
H0=16.5(Taped)  
Taping  
PO:17.0mm  
Q0:20.0mm

## Electrical Characteristics

### □ D-5 Series

Part Number	Rated Zero Power Resistance @25°C (Ω)	Maximum Steady Current @25°C (A)	Residual Resistor At Maximum Steady Current @25°C (Ω)	B Value (K) ±10%	Thermal Time Constant (S)	Heat Dissipation Coefficient (mW/°C)	Operating Temperature Range (°C)
5D-5	5	1	0.353	2500	<20	>6	-40°C ~ 155°C
10D-5	10	0.7	0.771	2600	<20	>6	-40°C ~ 155°C
15D-5	15	0.6	1.53	2600	<20	>6	-40°C ~ 155°C
20D-5	20	0.5	1.253	2600	<20	>6	-40°C ~ 155°C
22D-5	22	0.6	2.06	2600	<20	>6	-40°C ~ 155°C
30D-5	30	0.4	2.227	2600	<20	>6	-40°C ~ 155°C

Part Number	Rated Zero Power Resistance @25°C (Ω)	Maximum Steady Current @25°C (A)	Residual Resistor At Maximum Steady Current @25°C (Ω)	B Value (K) ±10%	Thermal Time Constant (S)	Heat Dissipation Coefficient (mW/°C)	Operating Temperature Range (°C)
33D-5	33	0.4	1.324	2600	<20	>6	-40°C ~ 155°C
50D-5	50	0.4	2.653	2800	<18	>6	-40°C ~ 155°C
60D-5	60	0.3	1.878	2800	<18	>6	-40°C ~ 155°C

## □D-7 Series

Part Number	Rated Zero Power Resistance @25°C (Ω)	Maximum Steady Current @25°C (A)	Residual Resistor At Maximum Steady Current @25°C (Ω)	B Value (K) ±10%	Thermal Time Constant (S)	Heat Dissipation Coefficient (mW/°C)	Operating Temperature Range (°C)
5D-7	5	2	0.283	2600	<30	>10	-40°C ~ 175°C
8D-7	8	1	0.539	2600	<28	>9	-40°C ~ 175°C
10D-7	10	1	0.616	2800	<27	>9	-40°C ~ 175°C
12D-7	12	1	0.816	2800	<27	>9	-40°C ~ 175°C
16D-7	16	0.7	1.003	2800	<27	>9	-40°C ~ 175°C
20D-7	20	0.6	1.102	2800	<27	>9	-40°C ~ 175°C
22D-7	22	0.6	1.108	2800	<27	>9	-40°C ~ 175°C
30D-7	30	0.5	3.7059	2800	<28	>10	-40°C ~ 175°C
33D-7	33	0.2	1.485	2800	<28	>10	-40°C ~ 175°C
50D-7	50	0.5	1.653	2800	<28	>10	-40°C ~ 175°C

## □D-9 Series

Part Number	Rated Zero Power Resistance @25°C (Ω)	Maximum Steady Current @25°C (A)	Residual Resistor At Maximum Steady Current @25°C (Ω)	B Value (K) ±10%	Thermal Time Constant (S)	Heat Dissipation Coefficient (mW/°C)	Operating Temperature Range (°C)
3D-9	3	4	0.120	2600	<35	>11	-40°C ~ 175°C
4D-9	4	3	0.190	2600	<35	>11	-40°C ~ 175°C
5D-9	5	3	0.210	2600	<34	>11	-40°C ~ 175°C
6D-9	6	2	0.315	2600	<34	>11	-40°C ~ 175°C
7D-9	7	2	0.3265	2800	<34	>11	-40°C ~ 175°C
8D-9	8	2	0.400	2800	<32	>11	-40°C ~ 175°C
10D-9	10	2	0.458	2800	<32	>11	-40°C ~ 175°C
12D-9	12	1	0.652	2800	<32	>11	-40°C ~ 175°C
16D-9	16	1	0.802	2800	<31	>11	-40°C ~ 175°C

Part Number	Rated Zero Power Resistance @25°C (Ω)	Maximum Steady Current @25°C (A)	Residual Resistor At Maximum Steady Current @25°C (Ω)	B Value (K) ±10%	Thermal Time Constant (S)	Heat Dissipation Coefficient (mW/°C)	Operating Temperature Range (°C)
20D-9	20	1	0.864	3000	<30	>11	-40°C ~ 175°C
22D-9	22	1	0.950	3000	<30	>11	-40°C ~ 175°C
30D-9	30	1	1.022	3000	<30	>11	-40°C ~ 175°C
33D-9	33	1	1.124	3000	<30	>11	-40°C ~ 175°C
50D-9	50	1	1.252	3200	<30	>11	-40°C ~ 175°C
60D-9	60	0.8	1.502	3200	<31	>11	-40°C ~ 175°C
80D-9	80	0.8	2.010	3200	<30	>11	-40°C ~ 175°C
120D-9	120	0.8	3.015	3200	<30	>11	-40°C ~ 175°C
200D-9	200	0.5	5.007	3400	<32	>11	-40°C ~ 175°C

## □D-11 Series

Part Number	Rated Zero Power Resistance @25°C (Ω)	Maximum Steady Current @25°C (A)	Residual Resistor At Maximum Steady Current @25°C (Ω)	B Value (K) ±10%	Thermal Time Constant (S)	Heat Dissipation Coefficient (mW/°C)	Operating Temperature Range (°C)
2.5D-11	2.5	5	0.095	2600	<43	>13	-40°C ~ 175°C
3D-11	3	5	0.100	2600	<43	>13	-40°C ~ 175°C
4D-11	4	4	0.150	2600	<44	>13	-40°C ~ 175°C
5D-11	5	4	0.156	2800	<45	>13	-40°C ~ 175°C
6D-11	6	3	0.240	2800	<45	>13	-40°C ~ 175°C
7D-11	7	3	0.2824	2800	<45	>13	-40°C ~ 175°C
8D-11	8	3	0.255	2800	<47	>14	-40°C ~ 175°C
10D-11	10	3	0.275	2800	<47	>14	-40°C ~ 175°C
12D-11	12	2	0.462	2800	<48	>14	-40°C ~ 175°C
15D-11	15	2	0.468	2800	<50	>14	-40°C ~ 175°C
16D-11	16	2	0.470	2800	<50	>14	-40°C ~ 175°C
20D-11	20	2	0.512	3000	<52	>15	-40°C ~ 175°C
22D-11	22	2	0.563	3000	<52	>15	-40°C ~ 175°C
25D-11	25	2	0.623	3000	<52	>15	-40°C ~ 175°C
30D-11	30	1.5	0.667	3000	<52	>15	-40°C ~ 175°C
33D-11	33	1.5	0.734	3000	<52	>15	-40°C ~ 175°C
47D-11	47	1.5	1.002	3200	<52	>15	-40°C ~ 175°C
50D-11	50	1.5	1.021	3200	<52	>15	-40°C ~ 175°C

Part Number	Rated Zero Power Resistance @25°C (Ω)	Maximum Steady Current @25°C (A)	Residual Resistor At Maximum Steady Current @25°C (Ω)	B Value (K) ±10%	Thermal Time Constant (S)	Heat Dissipation Coefficient (mW/°C)	Operating Temperature Range (°C)
60D-11	60	1.5	1.215	3200	<52	>15	-40°C ~ 175°C
80D-11	80	1.2	1.656	3200	<52	>15	-40°C ~ 175°C
120D-11	120	1.1	2.253	3000	<50	>15	-40°C ~ 175°C

## □D-13 Series

Part Number	Rated Zero Power Resistance @25°C (Ω)	Maximum Steady Current @25°C (A)	Residual Resistor At Maximum Steady Current @25°C (Ω)	B Value (K) ±10%	Thermal Time Constant (S)	Heat Dissipation Coefficient (mW/°C)	Operating Temperature Range (°C)
1.3D-13	1.3	7	0.062	2600	<60	>13	-40°C ~ 200°C
1.5D-13	1.5	7	0.073	2600	<60	>13	-40°C ~ 200°C
2.5D-13	2.5	6	0.088	2600	<60	>13	-40°C ~ 200°C
3D-13	3	6	0.092	2600	<60	>14	-40°C ~ 200°C
4D-13	4	5	0.120	2800	<67	>15	-40°C ~ 200°C
4.7D-13	4.7	5	0.1469	2800	<67	>15	-40°C ~ 200°C
5D-13	5	5	0.125	2800	<68	>15	-40°C ~ 200°C
6D-13	6	4	0.170	2800	<65	>15	-40°C ~ 200°C
7D-13	7	4	0.188	3000	<65	>15	-40°C ~ 200°C
8D-13	8	4	0.194	3000	<60	>15	-40°C ~ 200°C
10D-13	10	4	0.206	3000	<65	>15	-40°C ~ 200°C
12D-13	12	3	0.316	3200	<65	>16	-40°C ~ 200°C
15D-13	15	3	0.335	3200	<60	>16	-40°C ~ 200°C
16D-13	16	3	0.338	3200	<60	>16	-40°C ~ 200°C
18D-13	18	3	0.356	3200	<60	>16	-40°C ~ 200°C
20D-13	20	3	0.372	3200	<65	>16	-40°C ~ 200°C
22D-13	22	3	0.625	3200	<65	>16	-40°C ~ 200°C
25D-13	25	2.5	0.422	3200	<65	>16	-40°C ~ 200°C
30D-13	30	2.5	0.517	3200	<65	>16	-40°C ~ 200°C
33D-13	33	2.5	0.592	3200	<65	>16	-40°C ~ 200°C
47D-13	47	2	0.810	3200	<65	>17	-40°C ~ 200°C
50D-13	50	2	1.161	3200	<65	>13	-40°C ~ 200°C
120D-13	120	1.2	2.124	3400	<65	>17	-40°C ~ 200°C

## □D-15 Series

Part Number	Rated Zero Power Resistance @25°C (Ω)	Maximum Steady Current @25°C (A)	Residual Resistor At Maximum Steady Current @25°C (Ω)	B Value (K) ±10%	Thermal Time Constant (S)	Heat Dissipation Coefficient (mW/°C)	Operating Temperature Range (°C)
1.3D-15	1.3	8	0.048	2600	<68	>18	-40°C~200°C
1.5D-15	1.5	8	0.052	2600	<69	>18	-40°C~200°C
2.5D-15	2.5	7	0.065	2800	<76	>18	-40°C~200°C
3D-15	3	7	0.075	2800	<76	>18	-40°C~200°C
4D-15	4	6	0.1985	2800	<76	>18	-40°C~200°C
5D-15	5	6	0.112	3000	<76	>20	-40°C~200°C
6D-15	6	5	0.155	3000	<80	>20	-40°C~200°C
7D-15	7	5	0.173	3000	<80	>20	-40°C~200°C
8D-15	8	5	0.178	3000	<80	>20	-40°C~200°C
10D-15	10	5	0.180	3200	<75	>20	-40°C~200°C
12D-15	12	4	0.250	3200	<75	>20	-40°C~200°C
15D-15	15	4	0.268	3200	<85	>21	-40°C~200°C
16D-15	16	4	0.276	3200	<70	>21	-40°C~200°C
18D-15	18	4	0.3375	3200	<70	>21	-40°C~200°C
20D-15	20	4	0.288	3200	<86	>21	-40°C~200°C
22D-15	22	4	0.3812	3200	<86	>21	-40°C~200°C
25D-15	25	3.5	0.358	3200	<86	>21	-40°C~200°C
30D-15	30	3.5	0.438	3200	<75	>21	-40°C~200°C
33D-15	33	3	0.571	3200	<86	>21	-40°C~200°C
40D-15	40	3	0.587	3200	<86	>21	-40°C~200°C
47D-15	47	3	0.680	3200	<86	>21	-40°C~200°C
50D-15	50	3	0.734	3200	<86	>21	-40°C~200°C
120D-15	120	1.8	1.652	3400	<87	>22	-40°C~200°C

## □D-20 Series

Part Number	Rated Zero Power Resistance @25°C (Ω)	Maximum Steady Current @25°C (A)	Residual Resistor At Maximum Steady Current @25°C (Ω)	B Value (K) ±10%	Thermal Time Constant (S)	Heat Dissipation Coefficient (mW/°C)	Operating Temperature Range (°C)
0.7D-20	0.7	11	0.018	2400	<89	>24	-40°C~200°C
1.3D-20	1.3	9	0.037	2600	<88	>24	-40°C~200°C

Part Number	Rated Zero Power Resistance @25°C (Ω)	Maximum Steady Current @25°C (A)	Residual Resistor At Maximum Steady Current @25°C (Ω)	B Value (K) ±10%	Thermal Time Constant (S)	Heat Dissipation Coefficient (mW/°C)	Operating Temperature Range (°C)
2.2D-20	2.2	8	0.1292	2800	<88	>24	-40°C ~ 200°C
2.5D-20	2.5	8	0.052	2800	<88	>24	-40°C ~ 200°C
3D-20	3	8	0.055	2800	<88	>24	-40°C ~ 200°C
5D-20	5	7	0.087	3000	<87	>24	-40°C ~ 200°C
6D-20	6	6	0.113	3000	<103	>25	-40°C ~ 200°C
8D-20	8	6	0.142	3000	<105	>25	-40°C ~ 200°C
10D-20	10	6	0.162	3200	<102	>25	-40°C ~ 200°C
12D-20	12	5	0.195	3200	<100	>25	-40°C ~ 200°C
16D-20	16	5	0.212	3200	<100	>25	-40°C ~ 200°C

## Dimensions (mm) and Approval

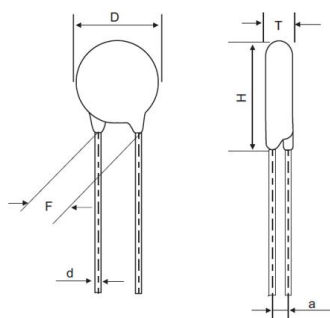

Part No.	Size (mm)					Approval	
	D Max.	T Max.	F±0.8	d±0.05		CQC	cUL (Canada)
				CP	CU		
□D-5	7.0	4.5	5.0	0.6	0.6	√	√
□D-7	9.0	5.0	5.0	0.6	0.6	√	√
□D-9	11.0	6.0	5.0	0.7	0.8	√	√
□D-11	13.0	6.5	7.5	0.7	0.8	√	√
□D-13	15.5	7.0	7.5	0.7	0.8	√	√
□D-15	17.5	7.0	7.5	0.7	0.8	√	√
□D-20	22.5	7.0	10.0	1.0	1.0	√	√

## Lead Configuration

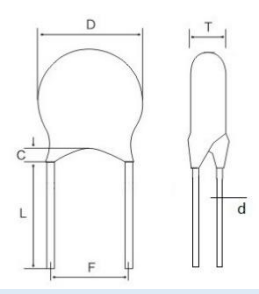
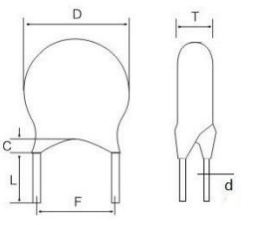
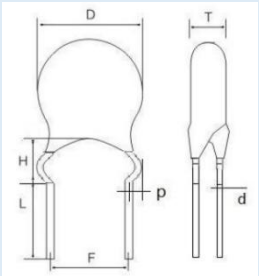
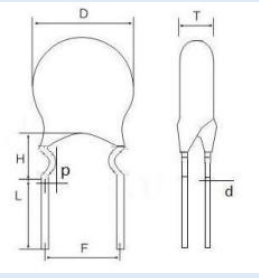
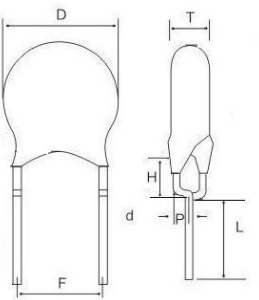
Lead Style	Drawing	Lead Length L (mm)	Coating Lead Length C (mm)	Height H (mm)
Long Straight		16.0 min	3.0 Max	/
Short Straight		①[2.5≤L<6.0]±0.5; ②[6.0≤L≤10]±1.0	3.0 Max	/
Outside Crimped		①[2.5≤L<6.0]±0.5; ②[6.0≤L≤10]±1.0	Not exceed the bend point	5.0mm Max
Inner Crimped		①[2.5≤L<6.0]±0.5; ②[6.0≤L≤10]±1.0	Not exceed the bend point	6.0mm Max
Vertical Crimped		①[2.5≤L<6.0]±0.5; ②[6.0≤L≤10]±1.0	Not exceed the bend point	4.0mm Max

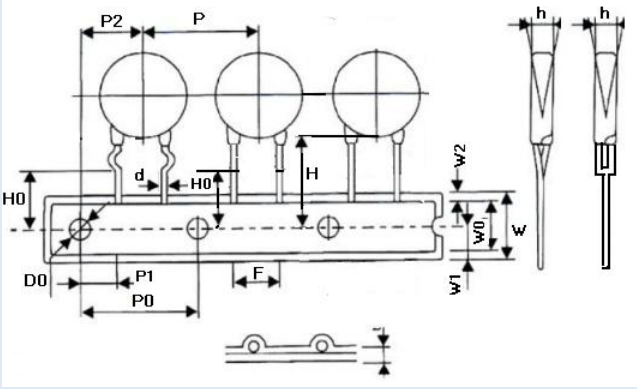
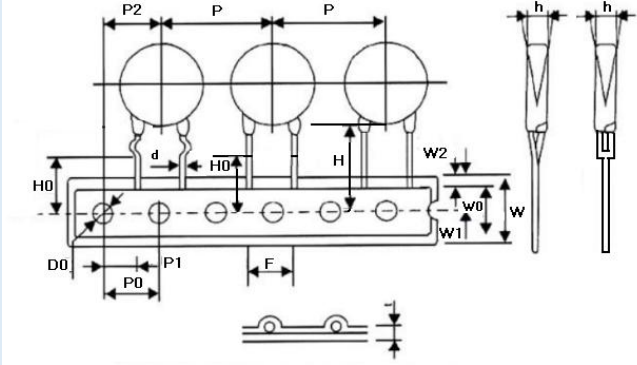

## Taping Specification (mm)

Figure	Fig.1		Fig.2				
	Symbol	P=5.0	P=7.5		P=10.0		
 <p>Fig.1 (P=5.0)</p>	Po	12.7±0.3	12.7±0.3	12.7±0.3			
	P	12.7±1.0	25.4±1.0	25.4±1.0			
	P1	3.85±0.7	8.95±0.7	7.7±0.7			
	P2	6.35±1.3	12.7±1.3	12.7±1.3			
	F	5±0.8	7.5±0.8	10.0±0.8			
	Δh	0±2.0	0±2.0	0±2.0			
	W	18.0+1.5/-1.0	18.0 +1.5/-1.0	18.0 +1.5/-1.0			
	Wo	10.5 Max	10.5 Max	10.5 Max			
	W1	9.0+0.75/-0.5	9.0+0.75/-0.5	9.0+0.75/-0.5			
	W2	3.0 Max	3.0 Max	3.0 Max			
	Do	4.0±0.2	4.0±0.2	4.0±0.2			
	 <p>Fig.2 (P=7.5 &amp; 10)</p>	H	20+1.5/-1.0	20+1.5/-1.0	20+1.5/-1.0		
		Ho	16.5&17.0 +1.5/-1.0	16.5&17.0 +1.5/-1.0	16.5&17.0 +1.5/-1.0		
		L	Straight Lead	Crimped Lead	Straight Lead	Crimped Lead	Straight Lead
11.0 Max			9.0 Max	11.0 Max	9.0 Max	11.0 Max	9.0 Max
t1		0.5±0.2	0.5±0.2	0.5±0.2			
t2		1.7 Max	1.7 Max	1.7 Max			