

FEATURES

- Complementary to S9014

MARKING: M6

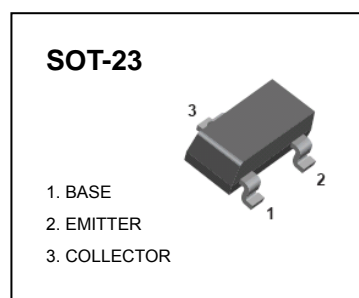

MAXIMUM RATINGS (T_a=25°C unless otherwise noted)

Symbol	Parameter	Value	Unit
V _{CB0}	Collector-Base Voltage	-50	V
V _{CEO}	Collector-Emitter Voltage	-45	V
V _{EBO}	Emitter-Base Voltage	-5	V
I _C	Collector Current -Continuous	-0.1	A
P _C	Collector Power Dissipation	0.2	W
T _j	Junction Temperature	150	°C
T _{stg}	Storage Temperature	-55-150	°C

ELECTRICAL CHARACTERISTICS (T_a=25°C unless otherwise specified)

Parameter	Symbol	Test conditions	Min	Typ	Max	Unit
Collector-base breakdown voltage	V _{(BR)CBO}	I _C = -100μA, I _E = 0	-50			V
Collector-emitter breakdown voltage	V _{(BR)CEO}	I _C = -0.1mA, I _B = 0	-45			V
Emitter-base breakdown voltage	V _{(BR)EBO}	I _E = -100μA, I _C = 0	-5			V
Collector cut-off current	I _{CBO}	V _{CB} = -50 V, I _E = 0			-0.1	μA
Emitter cut-off current	I _{EBO}	V _{EB} = -5V, I _C = 0			-0.1	μA
DC current gain	h _{FE}	V _{CE} = -5V, I _C = -1mA	200		1000	
Collector-emitter saturation voltage	V _{CE(sat)}	I _C = -100mA, I _B = -10mA			-0.3	V
Base-emitter saturation voltage	V _{BE(sat)}	I _C = -100mA, I _B = -10mA			-1	V
Transition frequency	f _T	V _{CE} = -5V, I _C = -10mA f = 30MHz	150			MHz

CLASSIFICATION OF h_{FE}

Rank	L	H
Range	200-450	450-1000

Typical Characteristics

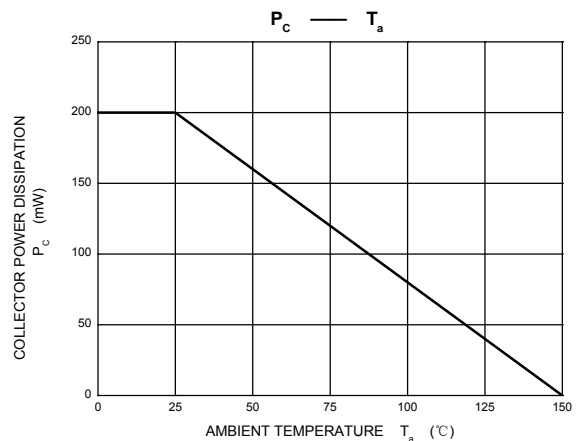
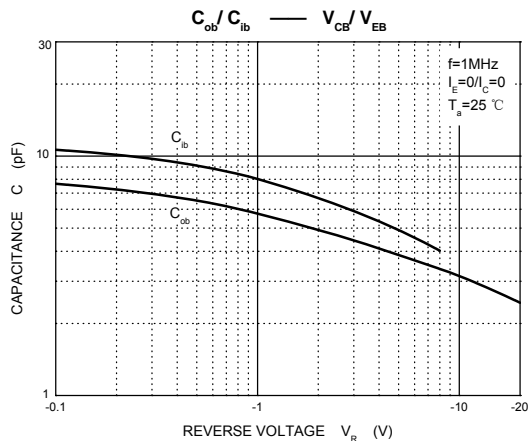
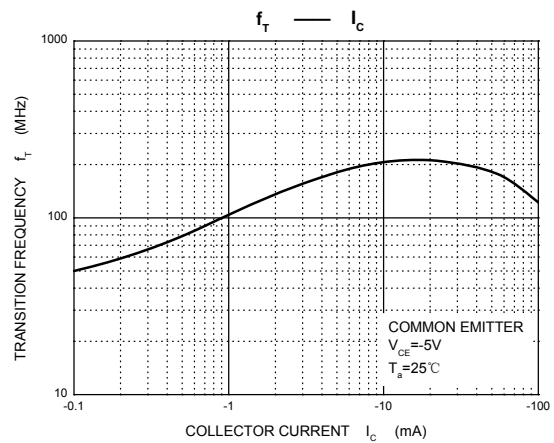
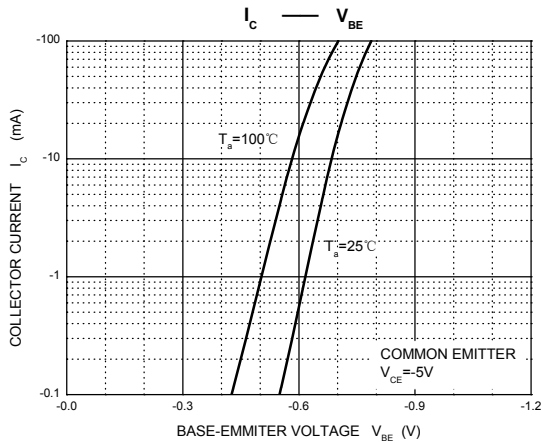
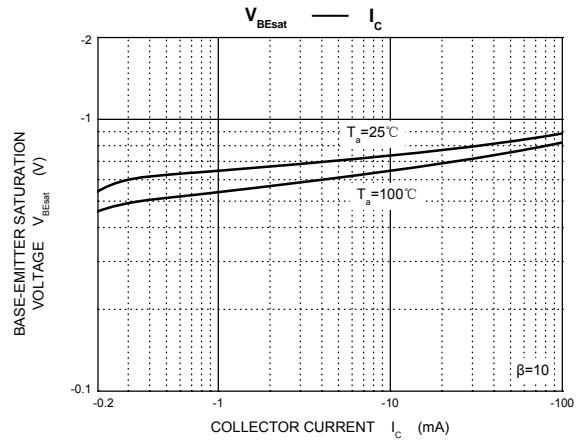
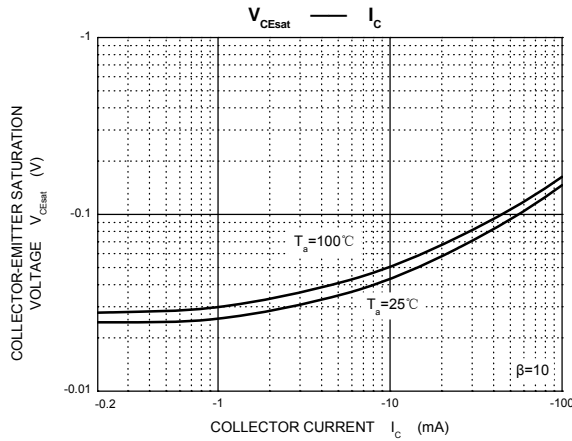
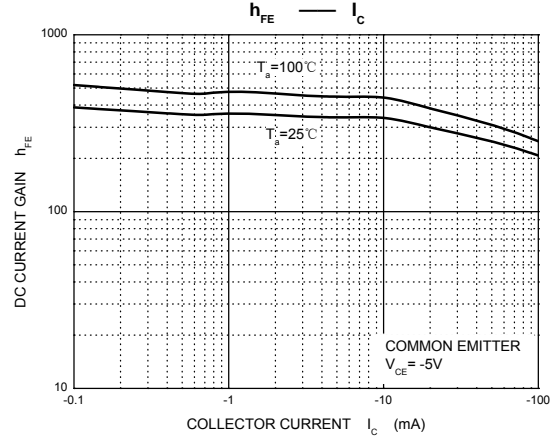
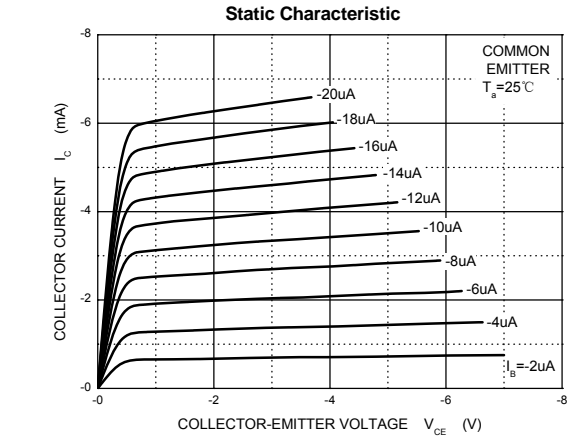

SOT-23 Package Outline Dimensions

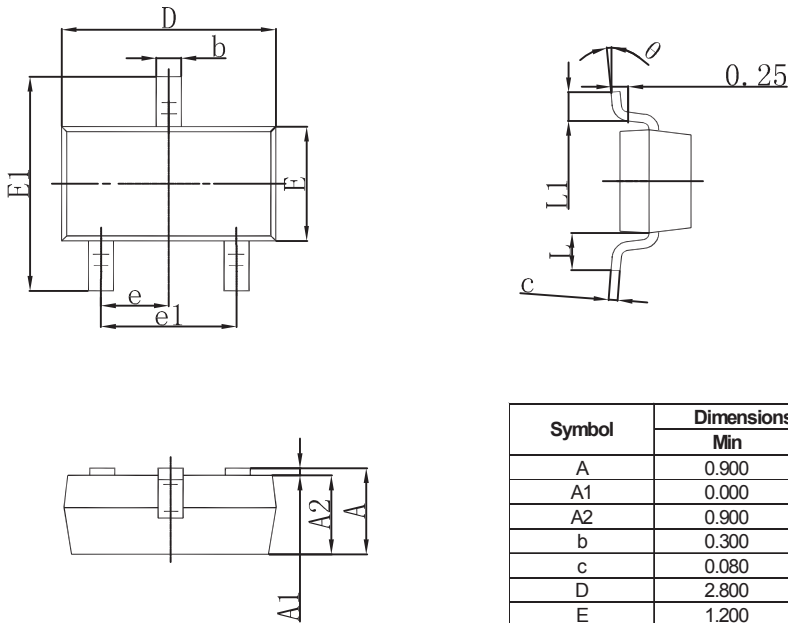

Symbol	Dimensions In Millimeters		Dimensions In Inches	
	Min	Max	Min	Max
A	0.900	1.150	0.035	0.045
A1	0.000	0.100	0.000	0.004
A2	0.900	1.050	0.035	0.041
b	0.300	0.500	0.012	0.020
c	0.080	0.150	0.003	0.006
D	2.800	3.000	0.110	0.118
E	1.200	1.400	0.047	0.055
E1	2.250	2.550	0.089	0.100
e	0.950 TYP		0.037 TYP	
e1	1.800	2.000	0.071	0.079
L	0.550 REF		0.022 REF	
L1	0.300	0.500	0.012	0.020
θ	0°	8°	0°	8°

SOT-23 Suggested Pad Layout

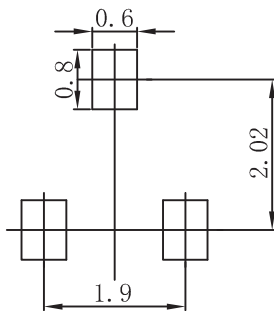

Note:

1. Controlling dimension; in millimeters.
2. General tolerance: ± 0.05 mm.
3. The pad layout is for reference purposes only.