

Low Dropout Linear Regulator

AMS1117-X.X (KMS1117-X.X)

■ Features

- Low dropout voltage
- Load regulation: 0.2% typical
- Optimized for Low Voltage
- On-chip thermal limiting
- 1A Adjustable/Fixed Low Dropout Linear Regulator
- Three-terminal adjustable or fixed low drop out
1.2V, 1.25V, 1.5V, 1.8V, 1.9V, 2.5V, 2.85V, 3.3V, 5V. Regulators

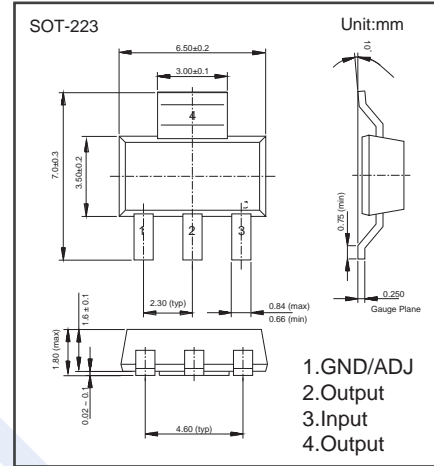

■ Absolute Maximum Ratings $T_a = 25^\circ\text{C}$

Parameter	Symbol	Rating	Unit
Input Voltage	V_{IN}	18	V
Thermal Resistance.Junction- to-Ambient (Note.1)	$R_{\theta JA}$	136	$^\circ\text{C}/\text{W}$
Thermal Resistance.Junction- to-Case	$R_{\theta JC}$	20	
Junction Temperature	T_J	150	$^\circ\text{C}$
Maximum Ambient Temperature	T_A	140	
Lead Temperature (10 sec)		300	
Storage Temperature Range	T_{stg}	-65 to 150	

Note.1: No air flow

■ Block Diagram

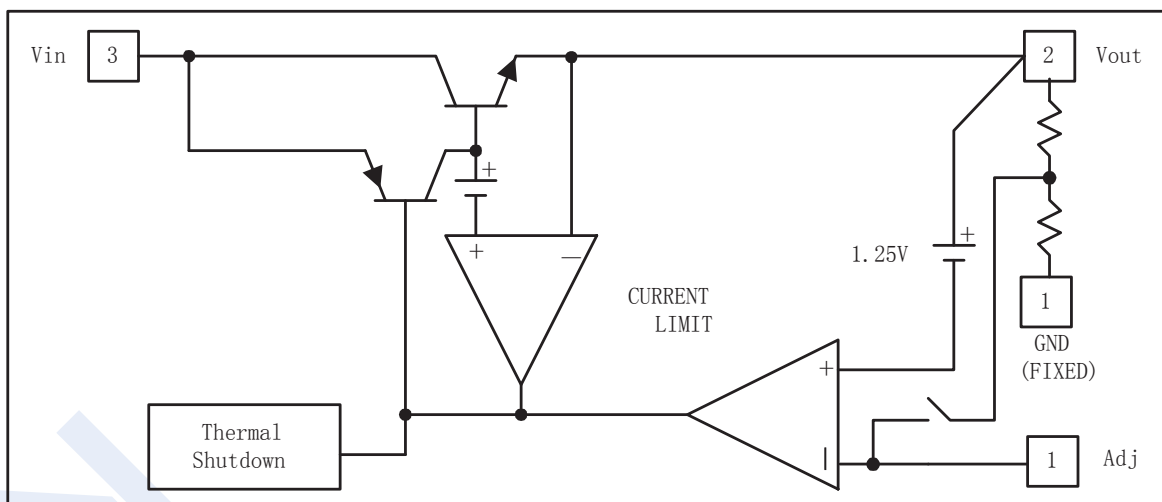

Low Dropout Linear Regulator

AMS1117-X.X (KMS1117-X.X)

■ Electrical Characteristics Ta = 25°C

Parameter	Symbol	Test Conditions		Min	Typ	Max	Unit
Reference Voltage	V _{REF}	AMS1117-ADJ	10mA ≤ I _{OUT} ≤ 800mA, 1.5V ≤ V _{IN} - V _{OUT} ≤ 12V	1.225	1.25	1.275	
Output Voltage	V _{OUT}	AMS1117-1.2	0 ≤ I _{OUT} ≤ 800mA, 2.6V ≤ V _{IN} - V _{OUT} ≤ 12V	1.175	1.2	1.225	V
		AMS1117-1.25	0 ≤ I _{OUT} ≤ 800mA, 2.65V ≤ V _{IN} - V _{OUT} ≤ 12V	1.238	1.25	1.275	
		AMS1117-1.5	0 ≤ I _{OUT} ≤ 800mA, 2.9V ≤ V _{IN} - V _{OUT} ≤ 12V	1.47	1.5	1.53	
		AMS1117-1.8	0 ≤ I _{OUT} ≤ 800mA, 3.2V ≤ V _{IN} - V _{OUT} ≤ 12V	1.764	1.8	1.836	
		AMS1117-1.9	0 ≤ I _{OUT} ≤ 800mA, 3.3V ≤ V _{IN} - V _{OUT} ≤ 12V	1.862	1.9	1.938	
		AMS1117-2.5	0 ≤ I _{OUT} ≤ 800mA, 3.9V ≤ V _{IN} - V _{OUT} ≤ 12V	2.45	2.5	2.55	
		AMS1117-2.85	0 ≤ I _{OUT} ≤ 800mA, 4.25V ≤ V _{IN} - V _{OUT} ≤ 12V	2.822	2.85	2.878	
		AMS1117-3.3	0 ≤ I _{OUT} ≤ 800mA, 4.75V ≤ V _{IN} - V _{OUT} ≤ 12V	3.234	3.3	3.366	
		AMS1117-5.0	0 ≤ I _{OUT} ≤ 800mA, 6.5V ≤ V _{IN} - V _{OUT} ≤ 12V	4.9	5	5.1	
Line Regulation	ΔV _{OUT}	AMS1117-ADJ	I _{OUT} =10mA, 1.5V ≤ V _{IN} -V _{OUT} ≤ 12V		0.035	0.2	%
		AMS1117-1.2	I _{OUT} =10mA, 2.6V ≤ V _{IN} -V _{OUT} ≤ 12V				
		AMS1117-1.25	I _{OUT} =10mA, 2.65V ≤ V _{IN} -V _{OUT} ≤ 12V				
		AMS1117-1.5	I _{OUT} =10mA, 2.9V ≤ V _{IN} -V _{OUT} ≤ 12V				
		AMS1117-1.8	I _{OUT} =10mA, 3.2V ≤ V _{IN} -V _{OUT} ≤ 12V				
		AMS1117-1.9	I _{OUT} =10mA, 3.3V ≤ V _{IN} -V _{OUT} ≤ 12V		9	12	
		AMS1117-2.5	I _{OUT} =10mA, 3.9V ≤ V _{IN} -V _{OUT} ≤ 12V				
		AMS1117-2.85	I _{OUT} =10mA, 4.25V ≤ V _{IN} -V _{OUT} ≤ 12V				
		AMS1117-3.3	I _{OUT} =10mA, 4.75V ≤ V _{IN} -V _{OUT} ≤ 12V				
		AMS1117-5.0	I _{OUT} =10mA, 6.5V ≤ V _{IN} -V _{OUT} ≤ 12V				
Load Regulation	ΔV _{OUT}	AMS1117-ADJ	V _{IN} -V _{OUT} =3V, 10mA ≤ I _{OUT} ≤ 800mA		0.2	0.4	%
		AMS1117-1.2	V _{IN} =2.6V, 10mA ≤ I _{OUT} ≤ 800mA				
		AMS1117-1.25	V _{IN} =2.65V, 10mA ≤ I _{OUT} ≤ 800mA				
		AMS1117-1.5	V _{IN} =2.9V, 10mA ≤ I _{OUT} ≤ 800mA				
		AMS1117-1.8	V _{IN} =3.2V, 10mA ≤ I _{OUT} ≤ 800mA				
		AMS1117-1.9	V _{IN} =3.3V, 10mA ≤ I _{OUT} ≤ 800mA		3	10	
		AMS1117-2.5	V _{IN} =3.9V, 10mA ≤ I _{OUT} ≤ 800mA				
		AMS1117-2.85	V _{IN} =4.25V, 10mA ≤ I _{OUT} ≤ 800mA				
		AMS1117-3.3	V _{IN} =4.75V, 10mA ≤ I _{OUT} ≤ 800mA				
		AMS1117-5.0	V _{IN} =6.5V, 10mA ≤ I _{OUT} ≤ 800mA				
Dropout Voltage	V _{IN} -V _{OUT}	AMS1117-XXX	ΔV _{OUT} , ΔV _{REF} =1%, I _{OUT} =0.1A		1.11	1.2	V
			ΔV _{OUT} , ΔV _{REF} =1%, I _{OUT} =0.5A		1.18	1.25	
			ΔV _{OUT} , ΔV _{REF} =1%, I _{OUT} =0.8A		1.26	1.3	
Current Limit	I _{limit}	AMS1117-XXX	V _{IN} -V _{OUT} =5V, T _J = 25°C	1.25	1.4	1.6	A
		AMS1117-XXX	AMS1117-ADJ		5	10	mA
Adjust Pin Current	I _{ADJ}				55	120	uA
Adjust Pin Current Change	I _{Change}				0.2		

Low Dropout Linear Regulator

AMS1117-X.X (KMS1117-X.X)

■ Electrical Characteristics Ta = 25°C

Quiescent Current	I _q	AMS1117-1.2	V _{in} -V _{out} =1.25V		4	8	mA
		AMS1117-1.25					
		AMS1117-1.5					
		AMS1117-1.8					
		AMS1117-1.9					
		AMS1117-2.5					
		AMS1117-2.85					
		AMS1117-3.3					
		AMS1117-5.0					

■ Marking

Marking	1117-X.X K****
---------	-------------------

Low Dropout Linear Regulator

AMS1117-X.X (KMS1117-X.X)

■ Typical Applications

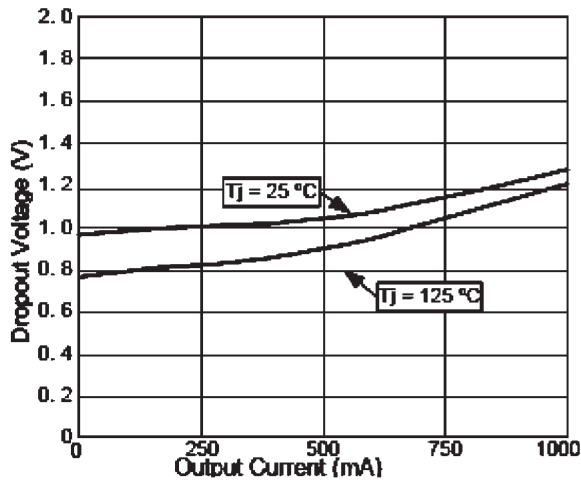

Fig.1 Dropout Voltage vs Output Current

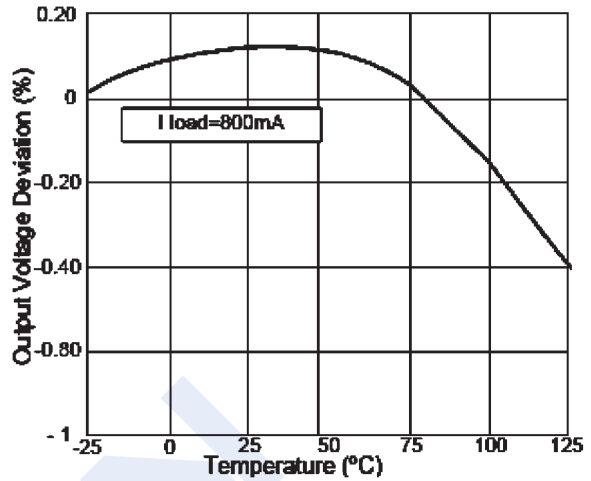

Fig.2 Load Regulation vs Temperature

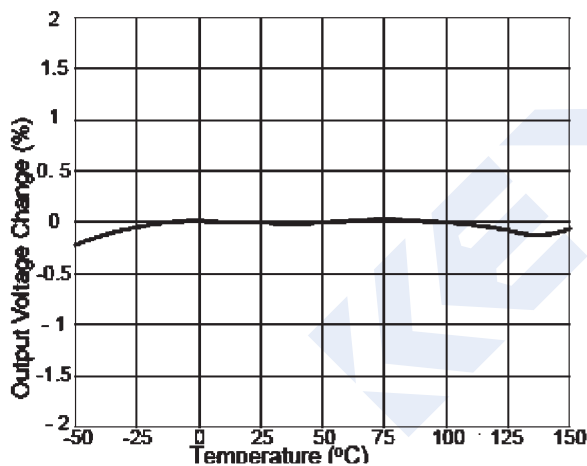

Fig.3 Percent Change in Output Voltage vs Temperature

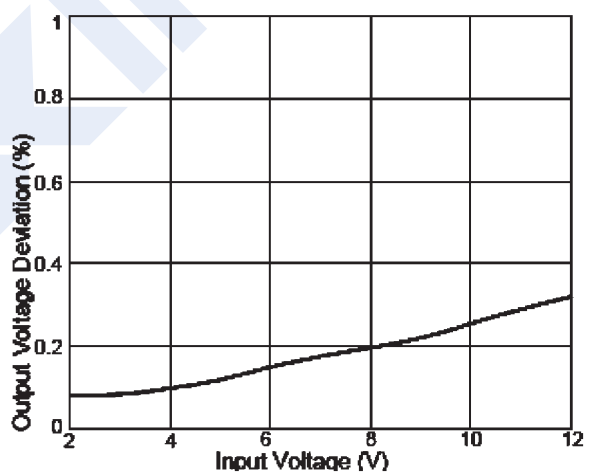

Fig.4 Line Regulation

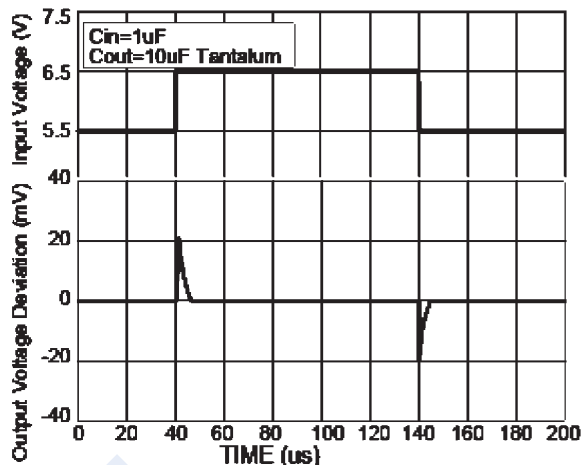

Fig.5 Line Transient Response

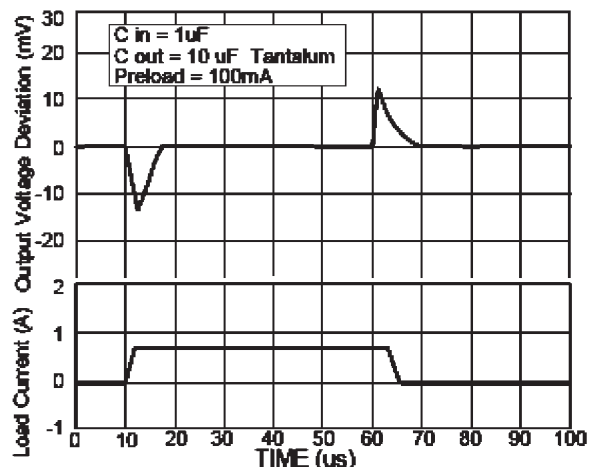

Fig.6 Load Transient Response