

### Description

The AU0521P1 is a bi-directional TVS diode, utilizing leading monolithic silicon technology to provide fast response time and low ESD clamping voltage, making this device an ideal solution for protecting voltage sensitive data and power line. The AU0521P1 complies with the IEC 61000-4-2 (ESD) with  $\pm 30$  kV air and  $\pm 30$  kV contact discharge. It is assembled into an ultra-small 1.0x0.6x0.5mm lead-free DFN package. The small size and high ESD surge protection make AU0521P1 an ideal choice to protect cell phone, digital cameras, audio players and many other portable applications.

### Features

- Ultra small package: 1.0x0.6x0.5mm
- Protects one data or power line
- Ultra low leakage: nA level
- Low operating voltage: 5V
- Low clamping voltage
- 2-pin leadless package
- Complies with following standards:
  - IEC 61000-4-2 (ESD) immunity test
    - Air discharge:  $\pm 30$ kV
    - Contact discharge:  $\pm 30$ kV
  - IEC61000-4-5 (Lightning) 8A (8/20 $\mu$ s)
- RoHS Compliant

### Mechanical Characteristics

- Package: DFN1006-2 (1.0x0.6x0.5mm)
- Case Material: “Green” Molding Compound.
- Moisture Sensitivity: Level 3 per J-STD-020
- Terminal Connections: See Diagram Below
- Marking Information: See Below

### Applications

- Cellular Handsets and Accessories
- Personal Digital Assistants
- Notebooks and Handhelds
- Portable Instrumentation
- Digital Cameras
- Peripherals
- Audio Players
- Keypads, Side Keys, LCD Displays

### Marking Information

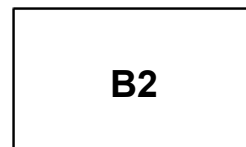

B2 = Device Marking Code

### Ordering Information

Part Number	Packaging	Reel Size
AU0521P1	10000/Tape & Reel	7 inch

### Dimensions and Pin Configuration

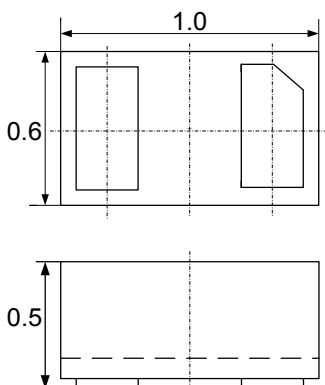

Package Dimensions

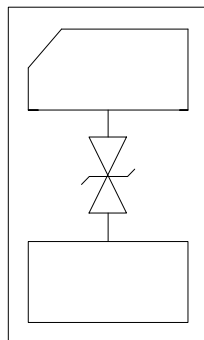

Circuit and Pin Schematic

**Absolute Maximum Ratings ( $T_A=25^{\circ}\text{C}$  unless otherwise specified)**

Parameter	Symbol	Value	Unit
Peak Pulse Power (8/20 $\mu\text{s}$ )	Ppk	100	W
Peak Pulse Current (8/20 $\mu\text{s}$ )	I <sub>PP</sub>	8	A
ESD per IEC 61000-4-2 (Air)	V <sub>ESD</sub>	$\pm 30$	kV
ESD per IEC 61000-4-2 (Contact)		$\pm 30$	
Operating Temperature Range	T <sub>J</sub>	-55 to +125	$^{\circ}\text{C}$
Storage Temperature Range	T <sub>stg</sub>	-55 to +150	$^{\circ}\text{C}$

**Electrical Characteristics ( $T_A=25^{\circ}\text{C}$  unless otherwise specified)**

Parameter	Symbol	Min	Typ	Max	Unit	Test Condition
Reverse Working Voltage	V <sub>RWM</sub>			5	V	
Breakdown Voltage	V <sub>BR</sub>	6		8	V	I <sub>T</sub> = 1mA
Reverse Leakage Current	I <sub>R</sub>			0.2	$\mu\text{A}$	V <sub>RWM</sub> = 5V
Clamping Voltage	V <sub>C</sub>			8	V	I <sub>PP</sub> = 1A
Clamping Voltage	V <sub>C</sub>			13	V	I <sub>PP</sub> = 8A
Junction Capacitance	C <sub>J</sub>		18		pF	V <sub>R</sub> = 0V, f = 1MHz

**Typical Performance Characteristics ( $T_A=25^\circ\text{C}$  unless otherwise Specified)**

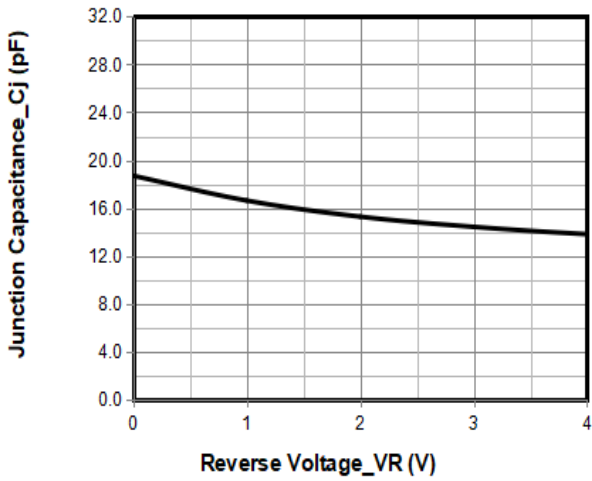

**Junction Capacitance vs. Reverse Voltage**

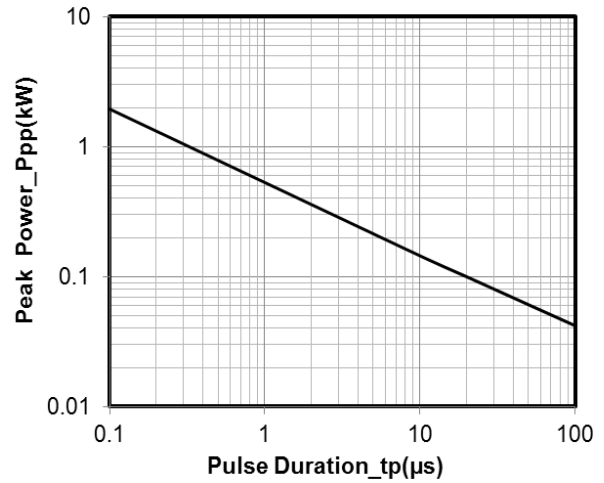

**Peak Pulse Power vs. Pulse Time**

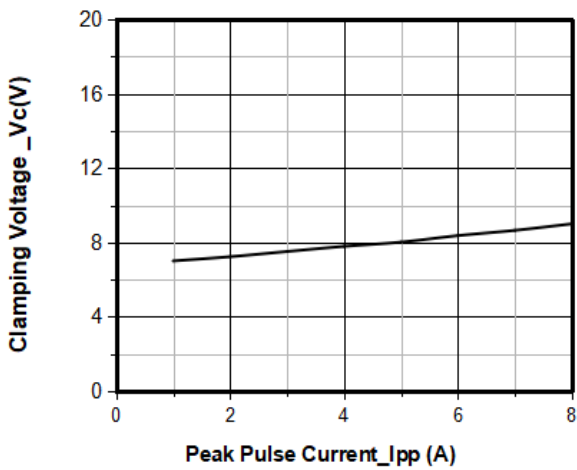

**Clamping Voltage vs. Peak Pulse Current ( $t_p = 8/20\mu\text{s}$ )**

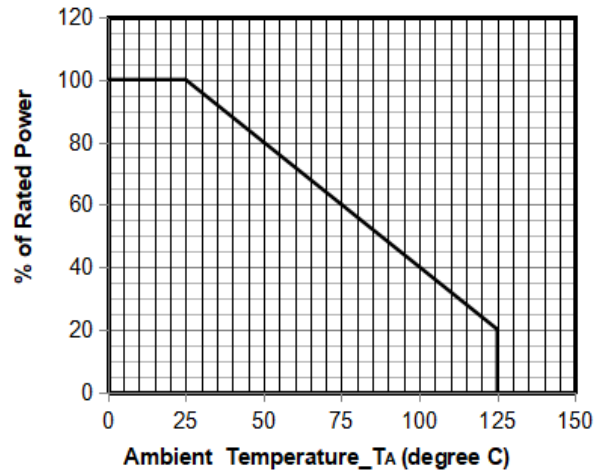

**Power Derating Curve**

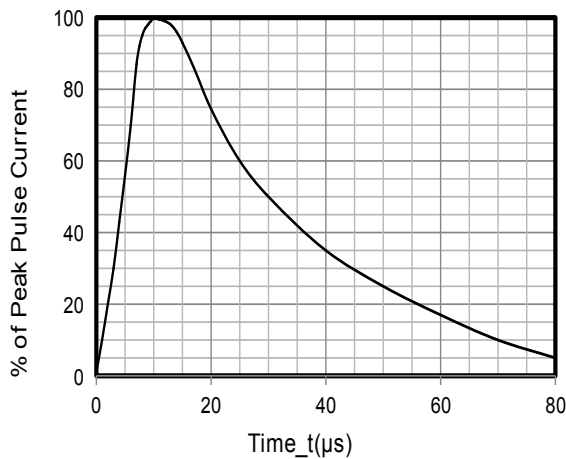

**8 X 20μs Pulse Waveform**

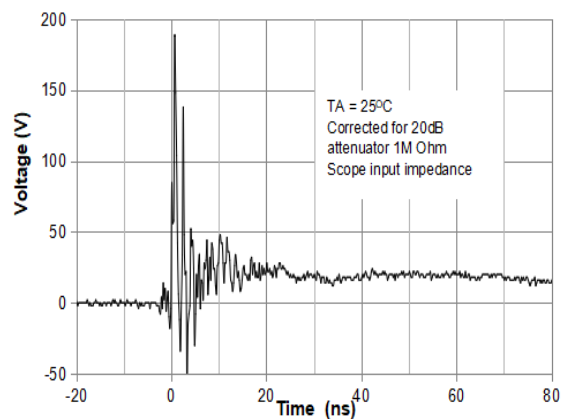

**ESD Clamping Voltage**  
**8 kV Contact per IEC61000-4-2**

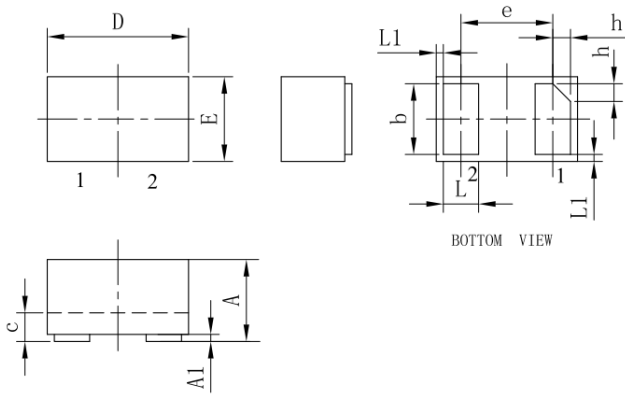
**DFN1006-2 Package Outline Drawing**

SYM	DIMENSIONS					
	MILLIMETERS			INCHES		
	MIN	NOM	MAX	MIN	NOM	MAX
A	0.45	0.50	0.55	0.018	0.020	0.022
A1	0.00	0.02	0.05	0.000	0.001	0.002
b	0.45	0.50	0.55	0.018	0.020	0.022
c	0.12	0.15	0.18	0.005	0.006	0.007
D	0.95	1.00	1.05	0.037	0.039	0.041
e	0.65 BSC			0.026 BSC		
E	0.55	0.60	0.65	0.022	0.024	0.026
L	0.20	0.25	0.30	0.008	0.010	0.012
L1	0.05REF			0.002REF		
h	0.07	0.12	0.17	0.003	0.005	0.007

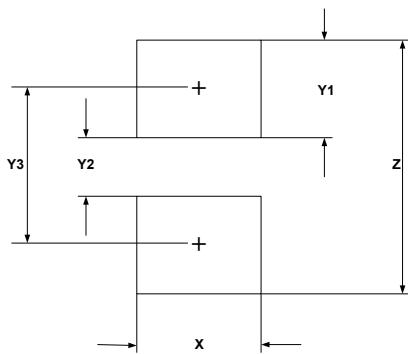
**Suggested Land Pattern**

SYM	DIMENSIONS	
	MILLIMETERS	INCHES
X	0.60	0.024
Y1	0.50	0.020
Y2	0.30	0.012
Y3	0.80	0.032
Z	1.30	0.052

**Contact Information**

Applied Power Microelectronics Co., Ltd.

 Website: <http://www.appliedpowermicro.com>

 Email: [sales@appliedpowermicro.com](mailto:sales@appliedpowermicro.com)

Phone: +86 (0519) 8399 3606

Applied Power Microelectronics Co., Ltd. (APM) reserves the right to make changes to the product specification and data in this document without notice. APM makes no warranty, representation or guarantee regarding the suitability of its products for any particular purpose, nor does APM assume any liability arising from the application or use of any products or circuits, and specifically disclaims any and all liability, including without limitation special, consequential or incidental damages.