

SEB40200

Schottky Barrier Diodes

Revision: A

General Description

This Schottky diode is for use in low voltage, high frequency rectifier of switching mode power supplier, DC/DC converters and polarity protection application.

- Low power loss, high efficiency
- Low Forward Voltage Drop
- High forward surge capacity

Features

- Case: TO-247, molded epoxy body with metal frame
- Terminal: Matte tin plated leads
- Polarity: See mark on body

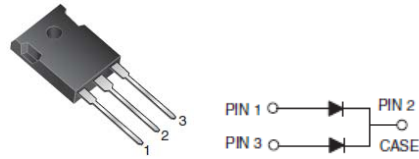

Maximum Ratings ($T_A=25^\circ\text{C}$ unless otherwise noted)

Parameter	Symbol	SEB40200	Units
Maximum repetitive peak reverse voltage	V_{RRM}	200	V
Maximum RMS voltage	V_{RMS}	140	V
Maximum DC blocking voltage	V_{DC}	200	V
Maximum average forward rectifier current	$I_{F(AV)}$	40	A
Peak forward surge current 8.3ms single half sine-wave superimposed on rated load	I_{FSM}	400	A
Operating Junction Temperature Range	T_J, T_{STG}	-50 to 150	$^\circ\text{C}$

Electrical Characteristics ($T_A=25^\circ\text{C}$ unless otherwise noted)

Parameter	Condition	Symbol	SEB40200	Units
Maximum instantaneous forward voltage	$I_F=40\text{A}$	V_F	0.83	V
Maximum DC reverse current at blocking voltage	$T_C=25^\circ\text{C}$	I_R	0.15	mA
	$T_C=125^\circ\text{C}$		25	

Thermal Characteristic ($T_A=25^\circ\text{C}$ unless otherwise noted)

Parameter	Symbol	SEB40200	Units
Typical Thermal resistance	$R_{\theta JA}^{(1)}$	4.5	$^\circ\text{C/W}$

1. Thermal resistance from junction to lead is based on 10 mm × 10 mm copper pad

Ratings and Characteristics Curves ($T_A=25^{\circ}\text{C}$ unless otherwise noted)

F1G.1-FORWARD CURRENT DERATING CURVE

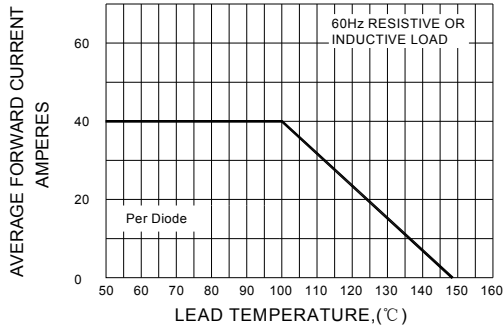

F1G.2-MAXIMUM NON-REPETITIVE PEAK FORWARD SURGE CURRENT

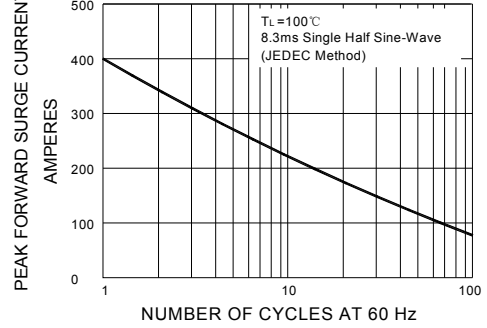

F1G.3-TYPICAL INSTANTANEOUS FORWARD CHARACTERISTICS

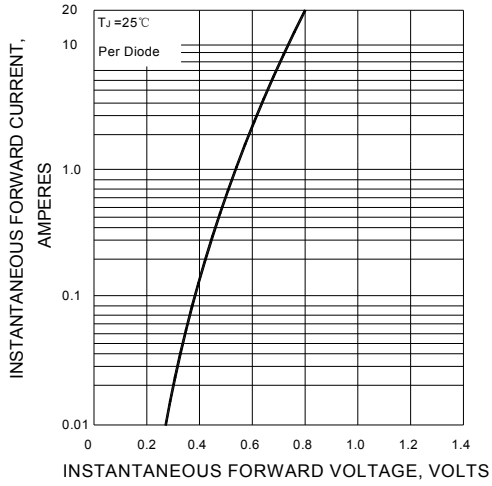

F1G.4-TYPICAL REVERSE CHARACTERISTICS

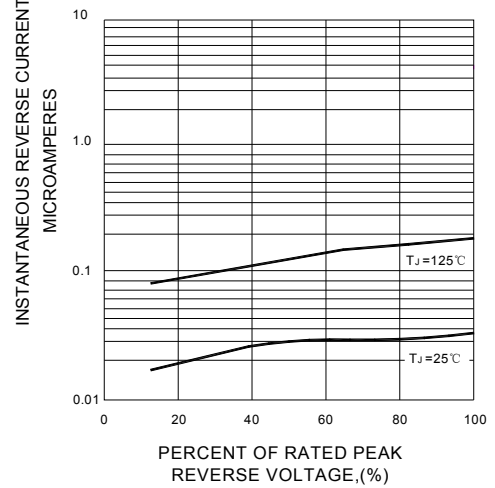

F1G.5-TYPICAL JUNCTION CAPACITANCE

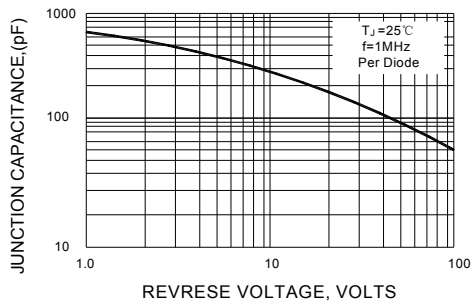

Package Outline Dimensions in inches and millimeters

TO-247

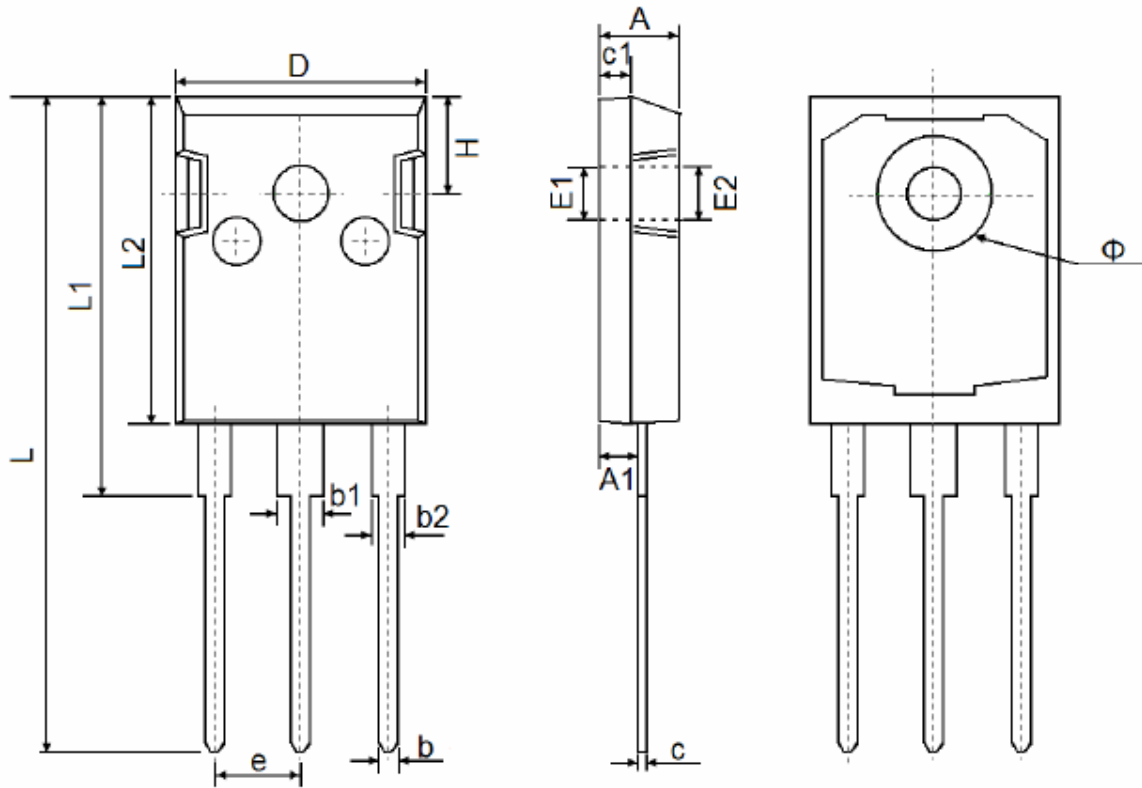

Symbol	Dimensions In Millimeters		Dimensions In Inches	
	Min.	Max.	Min.	Max.
A	4.850	5.150	0.191	0.200
A1	2.200	2.600	0.087	0.102
b	1.000	1.400	0.039	0.055
b1	2.800	3.200	0.110	0.126
b2	1.800	2.200	0.071	0.087
c	0.500	0.700	0.020	0.028
c1	1.900	2.100	0.075	0.083
D	15.450	15.750	0.608	0.620
E1	3.500 REF		0.138 REF	
E2	3.600 REF		0.142 REF	
L	40.900	41.300	1.610	1.626
L1	24.800	25.100	0.976	0.988
L2	20.300	20.600	0.799	0.811
φ	7.100	7.300	0.280	0.287
e	5.450 TYP		0.215 TYP	
H	5.980 REF		0.235 REF	

The SINO-IC logo is a registered trademark of ShangHai Sino-IC Microelectronics Co., Ltd.
© 2005 SINO-IC – Printed in China – All rights reserved.

SHANGHAI SINO-IC MICROELECTRONICS CO., LTD

Add: Building 3, Room 3401-03, No.200 Zhangheng Road, ZhangJiang Hi-Tech Park, Pudong,
Shanghai 201203, China

Phone: +86-21-33932402 33932403 33932405 33933508 33933608

Fax: +86-21-33932401

Email: webmaster@sino-ic.net

Website: <http://www.sino-ic.net>