

SESDA6V8UL

2-Line, Ultra-low Capacitance, Uni-directional TVS

Transient Voltage Suppressors

General Description

The SESDA6V8UL is a transient voltage suppressors (TVS) which provide a very high level protection for sensitive electronic components that may be subjected to electrostatic discharge (ESD). It is designed to replace multilayer varistors (MLV) in consumer equipments applications such as mobilephone, notebook, PAD, STB, LCD TV etc..

Applications

- Computers/Mobilephone
- PAD/STB
- LCD TV

Features

- Working voltage : 5V
- Small package
- Peak power (tp=8/20us) : 50W
- Low leakage current

Complies with the following standards

IEC61000-4-2

Level 4 15 kV (air discharge)

8 kV(contact discharge)

MIL STD 883E - Method 3015-7 Class 3

25 kV HBM (Human Body Model)

Functional diagram

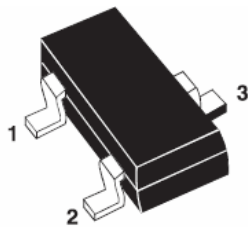

SOT-23

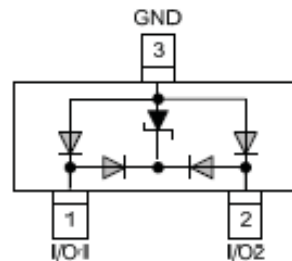

Absolute Ratings (T_{amb}=25°C)

Symbol	Parameter	Value	Units
P _{PP}	Peak Pulse Power (t _p = 8/20μs)	50	W
T _L	Maximum lead temperature for soldering during 10s	260	°C
T _{stg}	Storage Temperature Range	-55 to +155	°C
T _j	Maximum junction temperature	150	°C
I _{pp}	Peak Pulse Current (t _p = 8/20μs)	4	A
V _{PP}	Electrostatic discharge		
	IEC61000-4-2 air discharge	15	kV
	IEC61000-4-2 contact discharge	8	

Electrical Parameter

Symbol	Parameter
I_{PP}	Maximum Reverse Peak Pulse Current
V_C	Clamping Voltage @ I_{PP}
V_{RWM}	Working Peak Reverse Voltage
I_R	Maximum Reverse Leakage Current @ V_{RWM}
I_T	Test Current
V_{BR}	Breakdown Voltage @ I_T

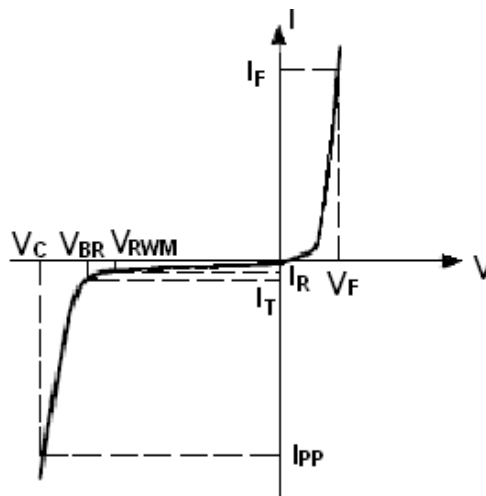

Electrical Characteristics

Part Numbers	V_{BR}			I_T	V_{RWM}	I_R	C
	Min.	Typ.	Max.				Typ. 0v bias
	V	V	V				pF
SESDA6V8UL	6.1	7.0	8.5	1	5.0	1	0.8

1).8/20 waveform used. (see fig2.)

Typical Characteristics

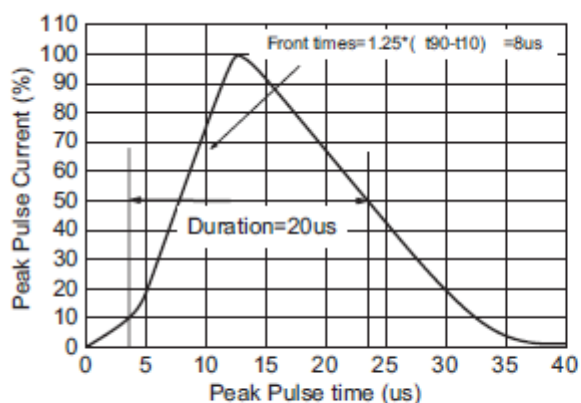

8/20us waveform

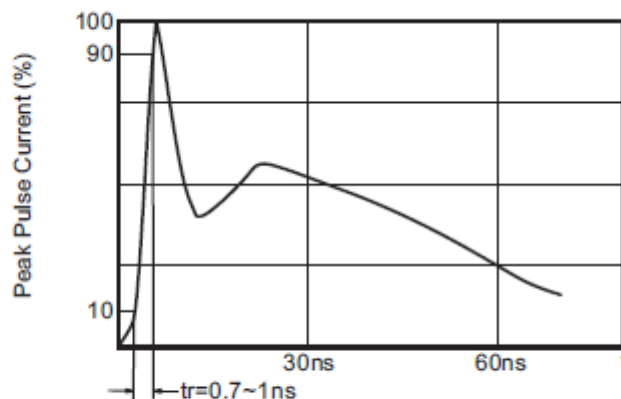

IEC61000-4-2 waveform

Typical characteristics (Ta=25°C, unless otherwise noted)

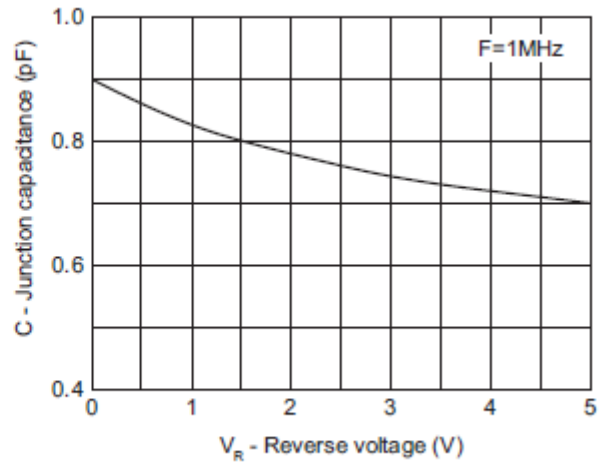
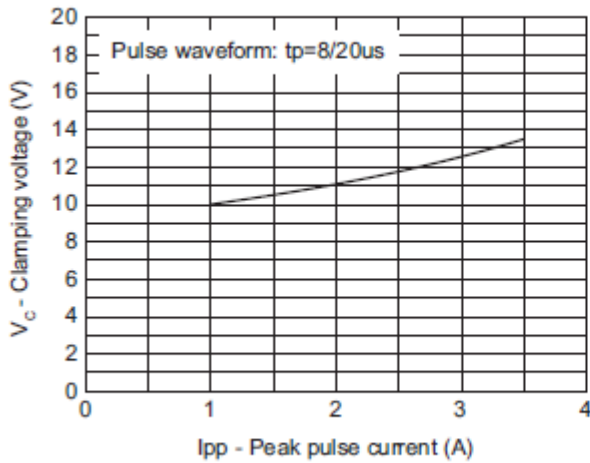

SOT-23 mechanical data

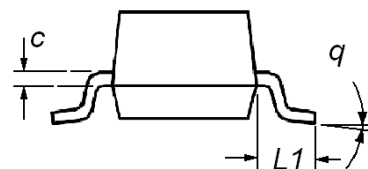
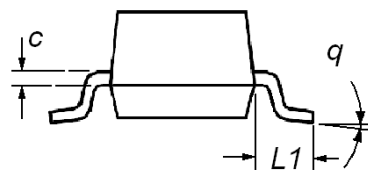
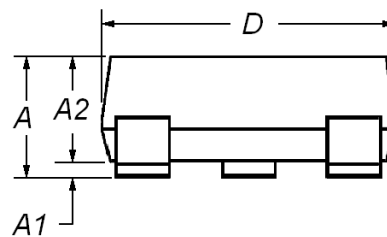
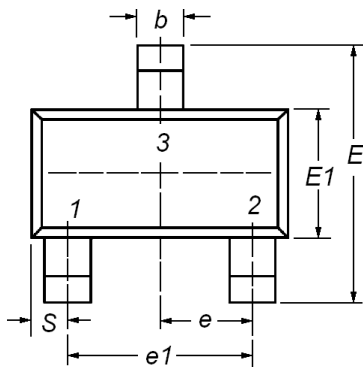

Dim	Millimeters		
	Min	TYP	Max
A	1.00	1.20	1.40
A1	0	0.05	0.10
A2	1.00	1.15	1.30
b	0.35	0.40	0.50
c	0.10	0.15	0.20
D	2.70	2.90	3.10
E	2.40	2.60	2.80
E1	1.40	1.50	1.60
e	0.85	1.00	1.15
e1	1.80	1.90	2.00
L1	0.40	.	
q	0°	5°	10°
S	0.45	0.50	0.55

The SINO-IC logo is a registered trademark of ShangHai Sino-IC Microelectronics Co., Ltd.
© 2005 SINO-IC – Printed in China – All rights reserved.

SHANGHAI SINO-IC MICROELECTRONICS CO., LTD

Add: Building 3, Room 3401-03, No.200 Zhangheng Road, ZhangJiang Hi-Tech Park, Pudong,
Shanghai 201203, China

Phone: +86-21-33932402 33932403 33932405 33933508 33933608

Fax: +86-21-33932401

Email: webmaster@sino-ic.com

Website: <http://www.sino-ic.com>