

- Features:
- Precision performance
 - RoHS compliant and halogen free
 - Highly stable performance over time
 - Tolerances of 0.1% may be available - contact factory for details
 - Temperature coefficient of resistance as low as $\pm 50\text{ppm}/^\circ\text{C}$
 - 0402 and 0603 package sizes are qualified to AEC-Q200



Electrical Specifications							
Type / Code	Power Rating (Watts) @ 70°C	Maximum Working Voltage ⁽¹⁾	Maximum Overload Voltage	TCR (ppm/°C)	Ohmic Range (Ω) and Tolerance		
					0.1%	0.5%	1%
RGC0201	0.05W	25V	50V	$\pm 200\text{ ppm}/^\circ\text{C}$	-	10 - 10M	-
RGC0402	0.063W	50V	100V	$\pm 50\text{ ppm}/^\circ\text{C}$	-	100 - 1M	
				$\pm 100\text{ ppm}/^\circ\text{C}$	-	10 - 1M	1 - 1M
				$\pm 200\text{ ppm}/^\circ\text{C}$	-	1.02M - 10M	-
RGC0603	0.1W	75V	150V	$\pm 50\text{ ppm}/^\circ\text{C}$	10 - 1M	10 - 10M	
				$\pm 100\text{ ppm}/^\circ\text{C}$	10 - 1M		1 - 10M
				$\pm 200\text{ ppm}/^\circ\text{C}$	-	1.02M - 10M	-
RGC0805	0.125W	150V	300V	$\pm 50\text{ ppm}/^\circ\text{C}$	10 - 1M	10 - 10M	
				$\pm 100\text{ ppm}/^\circ\text{C}$	10 - 1M		1 - 10M
				$\pm 200\text{ ppm}/^\circ\text{C}$	-	1.02M - 10M	-
RGC1206	0.25W	200V	400V	$\pm 50\text{ ppm}/^\circ\text{C}$	10 - 1M	10 - 10M	
				$\pm 100\text{ ppm}/^\circ\text{C}$	10 - 1M		1 - 10M
				$\pm 200\text{ ppm}/^\circ\text{C}$	-	1.02M - 10M	-
RGC1210	0.25W	200V	400V	$\pm 100\text{ ppm}/^\circ\text{C}$	-	-	1 - 9.76
	0.33W	200V	400V	$\pm 50\text{ ppm}/^\circ\text{C}$	10 - 1M	10 - 10M	
				$\pm 100\text{ ppm}/^\circ\text{C}$	10 - 1M		10 - 10M
RGC2010	0.75W	200V	400V	$\pm 200\text{ ppm}/^\circ\text{C}$	-	1.02M - 10M	-
				$\pm 50\text{ ppm}/^\circ\text{C}$	10 - 1M	10 - 10M	
				$\pm 100\text{ ppm}/^\circ\text{C}$	10 - 1M		1 - 10M
RGC2512	1W	200V	400V	$\pm 100\text{ ppm}/^\circ\text{C}$	-	-	1 - 9.76
		250V	500V	$\pm 50\text{ ppm}/^\circ\text{C}$	10 - 1M	10 - 10M	
				$\pm 100\text{ ppm}/^\circ\text{C}$	10 - 1M		10 - 10M
				$\pm 200\text{ ppm}/^\circ\text{C}$	-	1.02M - 10M	-

Note: (1) Lesser of $\sqrt{P \cdot R}$ or maximum working voltage

Power Derating Curve

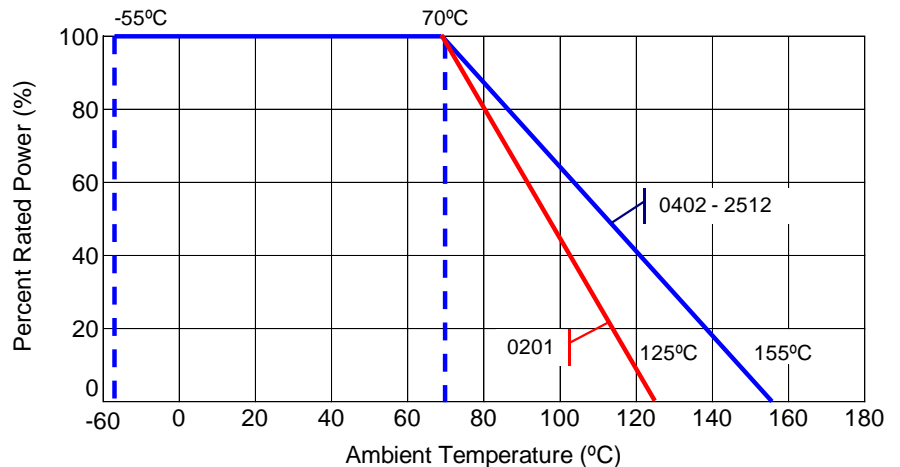

Mechanical Specifications

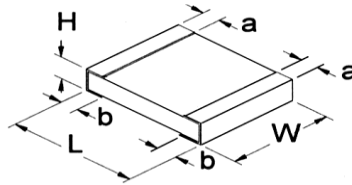

Type / Code	Weight (g) (1000 pc.)	L Body Length	W Body Width	H Body Height	a Top Termination	b Bottom Termination	Unit
RGC0201	0.150	0.024 ± 0.001 0.60 ± 0.03	0.012 ± 0.001 0.30 ± 0.03	0.009 ± 0.001 0.23 ± 0.03	0.006 ± 0.002 0.15 ± 0.05	0.006 ± 0.002 0.15 ± 0.05	inches mm
RGC0402	0.620	0.039 ± 0.004 1.00 ± 0.10	0.020 ± 0.002 0.50 ± 0.05	0.012 ± 0.004 0.30 ± 0.10	0.008 ± 0.004 0.20 ± 0.10	0.010 ± 0.006 0.25 ± 0.15	inches mm
RGC0603	2.042	0.063 ± 0.004 1.60 ± 0.10	0.031 ± 0.004 0.80 ± 0.10	0.018 ± 0.004 0.45 ± 0.10	0.012 ± 0.008 0.30 ± 0.20	0.012 ± 0.008 0.30 ± 0.20	inches mm
RGC0805	4.368	0.079 ± 0.004 2.00 ± 0.10	0.049 ± 0.004 1.25 ± 0.10	0.020 ± 0.004 0.50 ± 0.10	0.016 ± 0.010 0.40 ± 0.25	0.016 ± 0.008 0.40 ± 0.20	inches mm
RGC1206	8.947	0.122 ± 0.006 3.10 ± 0.15	0.061 ± 0.004 1.55 ± 0.10	0.024 ± 0.006 0.60 ± 0.15	0.020 ± 0.010 0.50 ± 0.25	0.020 ± 0.012 0.50 ± 0.30	inches mm
RGC1210	15.959	0.126 ± 0.010 3.20 ± 0.25	0.102 ± 0.006 2.60 ± 0.15	0.022 ± 0.004 0.55 ± 0.10	0.020 ± 0.010 0.50 ± 0.25	0.020 ± 0.008 0.50 ± 0.20	inches mm
RGC2010	24.241	0.197 ± 0.008 5.00 ± 0.20	0.098 ± 0.006 2.50 ± 0.15	0.022 ± 0.004 0.55 ± 0.10	0.024 ± 0.010 0.60 ± 0.25	0.024 ± 0.012 0.60 ± 0.30	inches mm
RGC2512	39.448	0.250 ± 0.008 6.35 ± 0.20	0.124 ± 0.008 3.15 ± 0.20	0.022 ± 0.004 0.55 ± 0.10	0.024 ± 0.010 0.60 ± 0.25	0.024 ± 0.012 0.60 ± 0.30	inches mm

Recommended Pad Layout

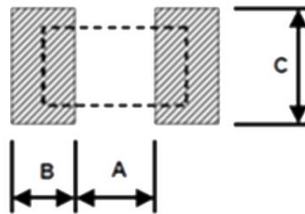

Type/Code	A	B	C	Unit
RGC0201	0.012 0.30	0.010 0.25	0.012 0.30	inches mm
RGC0402	0.020 0.50	0.018 0.45	0.024 0.60	inches mm
RGC0603	0.035 0.90	0.024 0.60	0.035 0.90	inches mm
RGC0805	0.047 1.20	0.028 0.70	0.051 1.30	inches mm
RGC1206	0.079 2.00	0.035 0.90	0.063 1.60	inches mm
RGC1210	0.079 2.00	0.035 0.90	0.110 2.80	inches mm
RGC2010	0.150 3.80	0.035 0.90	0.110 2.80	inches mm
RGC2512	0.193 4.90	0.063 1.60	0.138 3.50	inches mm

Soldering Profiles

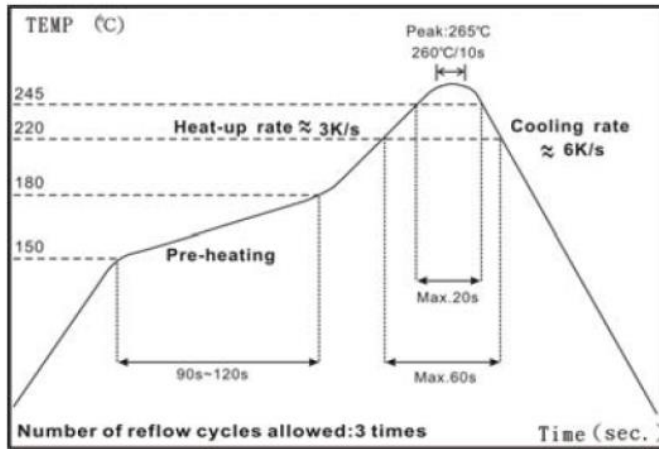

IR Reflow Soldering

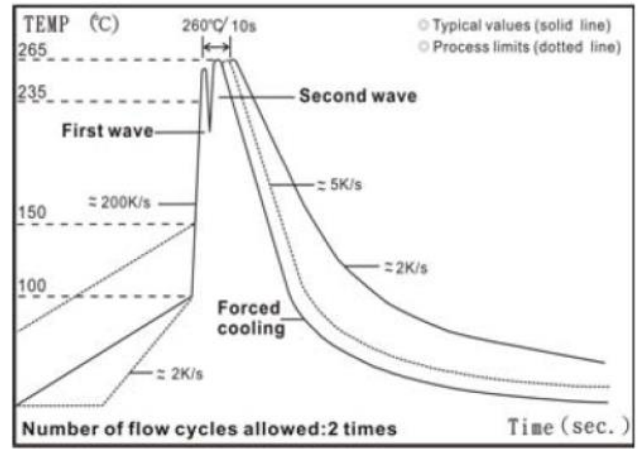

Wave Soldering (Flow Soldering)

- (1) Time of IR reflow soldering at maximum temperature point 260°C : 10s
- (2) Time of wave soldering at maximum temperature point 260°C : 10s
- (3) Time of soldering iron at maximum temperature point 410°C : 5s

Packaging Specifications

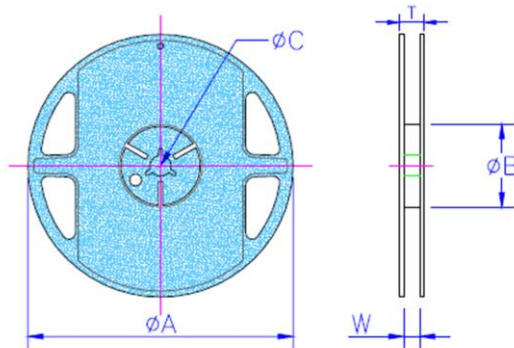

Type/Code	Packaging Description	Tape Width	Reel Diameter	A	B	C	W	T	Unit
RGC0201 RGC0402 RGC0603 RGC0805 RGC1206 RGC1210	Paper	8mm	7 inches	7.028 ± 0.059 178.50 ± 1.50	2.362 ± 0.039 60.00 ± 1.00	0.512 ± 0.008 13.00 ± 0.20	0.354 ± 0.020 9.00 ± 0.50	0.492 ± 0.020 12.50 ± 0.50	inches mm
RGC2010 RGC2512	Embossed	12mm	7 inches	7.028 ± 0.059 178.50 ± 1.50	2.362 ± 0.039 60.00 ± 1.00	0.512 ± 0.020 13.00 ± 0.50	0.512 ± 0.020 13.00 ± 0.50	0.610 ± 0.020 15.50 ± 0.50	inches mm

Paper Tape Specifications

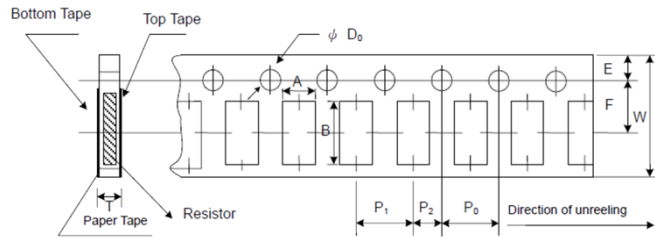

Type/Code	A	B	W	E	F	Unit
RGC0201	0.015 ± 0.002	0.027 ± 0.002	0.315 ± 0.008	0.069 ± 0.004	0.138 ± 0.002	inches
	0.38 ± 0.05	0.68 ± 0.05	8.00 ± 0.20	1.75 ± 0.10	3.50 ± 0.05	mm
RGC0402	0.026 ± 0.004	0.045 ± 0.004	0.315 ± 0.008	0.069 ± 0.004	0.138 ± 0.002	inches
	0.65 ± 0.10	1.15 ± 0.10	8.00 ± 0.20	1.75 ± 0.10	3.50 ± 0.05	mm
RGC0603	0.043 ± 0.004	0.075 ± 0.004	0.315 ± 0.008	0.069 ± 0.004	0.138 ± 0.002	inches
	1.10 ± 0.10	1.90 ± 0.10	8.00 ± 0.20	1.75 ± 0.10	3.50 ± 0.05	mm
RGC0805	0.063 ± 0.004	0.094 ± 0.008	0.315 ± 0.008	0.069 ± 0.004	0.138 ± 0.002	inches
	1.60 ± 0.10	2.40 ± 0.20	8.00 ± 0.20	1.75 ± 0.10	3.50 ± 0.05	mm
RGC1206	0.075 ± 0.004	0.138 ± 0.008	0.315 ± 0.008	0.069 ± 0.004	0.138 ± 0.002	inches
	1.90 ± 0.10	3.50 ± 0.20	8.00 ± 0.20	1.75 ± 0.10	3.50 ± 0.05	mm
RGC2010	0.114 ± 0.004	0.138 ± 0.008	0.315 ± 0.008	0.069 ± 0.004	0.138 ± 0.002	inches
	2.90 ± 0.10	3.50 ± 0.20	8.00 ± 0.20	1.75 ± 0.10	3.50 ± 0.05	mm
Type/Code	P0	P1	P2	D0	T	Unit
RGC0201	0.157 ± 0.004	0.079 ± 0.002	0.079 ± 0.002	0.059 ± 0.004	0.017 ± 0.008	inches
	4.00 ± 0.10	2.00 ± 0.05	2.00 ± 0.05	1.50 ± 0.10	0.42 ± 0.20	mm
RGC0402	0.157 ± 0.004	0.079 ± 0.002	0.079 ± 0.002	0.059 ± 0.004	0.018 ± 0.004	inches
	4.00 ± 0.10	2.00 ± 0.05	2.00 ± 0.05	1.50 ± 0.10	0.45 ± 0.10	mm
RGC0603	0.157 ± 0.004	0.157 ± 0.002	0.079 ± 0.002	0.059 ± 0.004	0.028 ± 0.004	inches
	4.00 ± 0.10	4.00 ± 0.05	2.00 ± 0.05	1.50 ± 0.10	0.70 ± 0.10	mm
RGC0805	0.157 ± 0.004	0.157 ± 0.002	0.079 ± 0.002	0.059 ± 0.004	0.033 ± 0.004	inches
	4.00 ± 0.10	4.00 ± 0.05	2.00 ± 0.05	1.50 ± 0.10	0.85 ± 0.10	mm
RGC1206	0.157 ± 0.004	0.157 ± 0.002	0.079 ± 0.002	0.059 ± 0.004	0.033 ± 0.004	inches
	4.00 ± 0.10	4.00 ± 0.05	2.00 ± 0.05	1.50 ± 0.10	0.85 ± 0.10	mm
RGC2010	0.157 ± 0.004	0.157 ± 0.002	0.079 ± 0.002	0.059 ± 0.004	0.033 ± 0.004	inches
	4.00 ± 0.10	4.00 ± 0.05	2.00 ± 0.05	1.50 ± 0.10	0.85 ± 0.10	mm

Embossed Tape Specifications

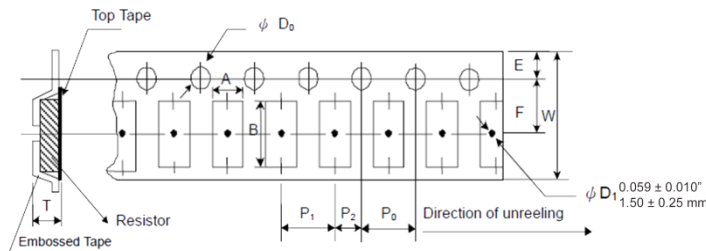

Type/Code	A	B	W	E	F	Unit
RGC2010	0.110 ± 0.004	0.217 ± 0.004	0.472 ± 0.012	0.069 ± 0.004	0.217 ± 0.002	inches
	2.80 ± 0.10	5.50 ± 0.10	12.00 ± 0.30	1.75 ± 0.10	5.50 ± 0.05	mm
RGC2512	0.138 ± 0.004	0.264 ± 0.004	0.472 ± 0.012	0.069 ± 0.004	0.217 ± 0.002	inches
	3.50 ± 0.10	6.70 ± 0.10	12.00 ± 0.30	1.75 ± 0.10	5.50 ± 0.05	mm
Type/Code	P0	P1	P2	D0	T	Unit
RGC2010	0.157 ± 0.004	0.157 ± 0.004	0.079 ± 0.002	0.059 ± 0.004	0.047 ± 0.000	inches
	4.00 ± 0.10	4.00 ± 0.10	2.00 ± 0.05	1.50 ± 0.10	1.20 ± 0.00	mm
RGC2512	0.157 ± 0.004	0.157 ± 0.004	0.079 ± 0.002	0.059 ± 0.004	0.047 ± 0.000	inches
	4.00 ± 0.10	4.00 ± 0.10	2.00 ± 0.05	1.50 ± 0.10	1.20 ± 0.00	mm

Performance Characteristics				
Test	Test Specification			Test Method
	± 1% and below	± 5%	Jumper	
Temperature Coefficient of Resistance	As specified.			JIS-C-5201-1 4.8 IEC-60115-1 4.8 -55°C +125 C, 25°C is the reference temperature
Short Time Overload	±(1.0%+0.05Ω)	±(2.0%+0.05Ω)	<50mΩ	JIS-C-5201-1 4.13 IEC-60115-1 4.13 RCWV*2.5 or max. overload voltage whichever is lower for 5 seconds; 2 seconds for high power series
Insulation resistance	≥10G			JIS-C-5201-1 4.6 IEC-60115-1 4.6 Max. overload voltage for 1 minute
Endurance	±(1.0%+0.10Ω)	±(2.0%+0.10Ω)	<100mΩ	JIS-C-5201-1 4.25 IEC-60115-1 4.25.1 70±2°C, RCWV for 1000 h. with 1.5 h. "ON" and 0.5 h. "OFF"
Damp Heat with Load	±(1.0%+0.10Ω)	±(2.0%+0.10Ω)	<100mΩ	JIS-C-5201-1 4.24 IEC-60115-1 4.24 40±2°C, 90~95% R.H., RCWV for 1000 h. with 1.5 h. "ON" and 0.5 h. "OFF"
Dry Heat	±(1.0%+0.05Ω)	±(1.5%+0.10Ω)	<50mΩ	JIS-C-5201-1 4.23 IEC-60115-1 4.23.2 at +125/+155°C for 1000 h.
Bending Strength	±(1.0%+0.05Ω)	±(1.0%+0.05Ω)	<50mΩ	JIS-C-5201-1 4.33 IEC-60115-1 4.33 Bending once for 5 seconds 2010, 2512 sizes: 2mm; other sizes: 3mm
Solderability	95% minimum coverage			JIS-C-5201-1 4.17 IEC-60115-1 4.17 245±5°C for 3 seconds
Resistance to Soldering Heat	±(0.5%+0.05Ω)	±(1.0%+0.05Ω)	<50mΩ	JIS-C-5201-1 4.18 IEC-60115-1 4.18 260±5°C for 10 seconds
Voltage Proof	No breakdown or flashover			JIS-C-5201-1 4.7 IEC-60115-1 4.7 1.42 times max. operating voltage for 1 minute
Leaching	Individual leaching area ≤5% Total leaching area ≤10%			JIS-C-5201-1 4.18 IEC-60068-2-58 8.2.1 260±5°C for 30 seconds
Rapid Change of Temperature	±(0.5%+0.05Ω)	±(1.0%+0.05Ω)	<50mΩ	JIS-C-5201-1 4.19 IEC-60115-1 4.19 -55°C to +125/+155°C, 5 cycles

RCWV (Rated Continuous Working Voltage) = $\sqrt{P \cdot R}$ or max. operating voltage whichever is lower
Storage Temperature: 25±3°C; humidity < 80% RH

RoHS Compliance

Stackpole Electronics has joined the worldwide effort to reduce the amount of lead in electronic components and to meet the various regulatory requirements now prevalent, such as the European Union's directive regarding "Restrictions on Hazardous Substances" (RoHS 2). As part of this ongoing program, we periodically update this document with the status regarding the availability of our compliant components. All our standard part numbers are compliant to EU Directive 2011/65/EU of the European Parliament.

RoHS Compliance Status						
Standard Product Series	Description	Package / Termination Type	Standard Series RoHS Compliant	Lead-Free Termination Composition	Lead-Free Mfg. Effective Date (Std Product Series)	Lead-Free Effective Date Code (YY/WW)
RGC	Semi-Precision Thick Film Surface Mount Resistor	SMD	YES(1)	100% Matte Sn over Ni	Jul-04	04/27

Note (1): RoHS Compliant by means of exemption 7c-1.

"Conflict Metals" Commitment

We at Stackpole Electronics, Inc. are joined with our industry in opposing the use of metals mined in the "conflict region" of the Eastern Democratic Republic of the Congo (DRC) in our products. Recognizing that the supply chain for metals used in the electronics industry is very complex, we work closely with our own suppliers to verify to the extent possible that the materials and products we supply do not contain metals sourced from this conflict region. As such, we are in compliance with the requirements of Dodd-Frank Act regarding Conflict Minerals.

Compliance to "REACH"

We certify that all passive components supplied by Stackpole Electronics, Inc. are SVHC (Substances of Very High Concern) free and compliant with the requirements of EU Directive 1907/2006/EC, "The Registration, Evaluation, Authorization and Restriction of Chemicals", otherwise referred to as REACH. Contact us for complete list of REACH Substance Candidate List.

Environmental Policy

It is the policy of Stackpole Electronics, Inc. (SEI) to protect the environment in all localities in which we operate. We continually strive to improve our effect on the environment. We observe all applicable laws and regulations regarding the protection of our environment and all requests related to the environment to which we have agreed. We are committed to the prevention of all forms of pollution.

How to Order

1	2	3	4	5	6	7	8	9	10	11	12	13	14
R	G	C	0	6	0	3	F	T	C	4	K	7	0

Product Series	Size	Power	Tolerance			Packaging				TCR		Resistance Value
RGC	Semi-Precision Thick Film		Code	Tol	Value	Code	Description	Size	Quantity	Code	ppm	Four characters with the multiplier used as the decimal holder. 100 ohm = 100R 10.5 Kohm = 10K5 1 Mohm = 1M00
			B	0.1%	E24, E96	T	7" Reel Paper Tape	0201, 0402	10,000	C	50	
			D	0.5%					0603, 0805	5,000	D	100
			F	1%				1206, 1210		L	200	
								2010(*)	4,000			
								2512				

(*) RGC2010F 1Ω to 9.76Ω MOQ is 12,000