

Features:

- RoHS compliant
- Long operating life
- Ideal for backlight and indicator
- Various Colors brightness Available
- Moisture sensitivity level: 3

Application:

- Backlight
- Decoration lighting
- motormeter
- Indicator



Part Number	Dice Material	Emitted Color	Lens Color
E6C1204YGAC1UDA	GaP	Yellow Green	Water Clear

Electro-Optical Characteristics($T_a=25^{\circ}\text{C}$, @20mA)

Parameter	Symbol	Min.	Typ.	Max.	Unit
Luminous Intensity	IV	30	-	70	mcd
Radiation Bandwidth	$\Delta\lambda$	-	30	-	nm
Forward Voltage	VF	1.90	2.00	2.40	v
Luminous Flux	Φ	-	-	-	Lm
Dominant Wavelength	λ_d	567	570	575	nm
CIE Coordinates CIE	x,y	-	-	-	-
Color Temperature	Tc	-	-	-	k
Viewing Angle	$2\theta_{1/2}$	-	120	-	deg
Reverse Current	IR	-	-	10	uA

Absolute Maximum Ratings($T_a=25^{\circ}\text{C}$)

Parameter	Symbol	Max.	Unit
Peak Forward Current(1/10 Duty Cycle, 0.1ms Pulse Width)	IPF	100	mA
Forward Current	IF	30	mA
Reverse Voltage	VR	5	v
Electrostatic Discharge	ESD	2000	v
Operating Temperature Range	Topr	-40to+90	$^{\circ}\text{C}$
Storage Temperature Range	Tstg	-40to+90	$^{\circ}\text{C}$
Reflow Soldering	Tsld	260 $^{\circ}\text{C}$ for 10secs	



Optical & Electrical Characteristics

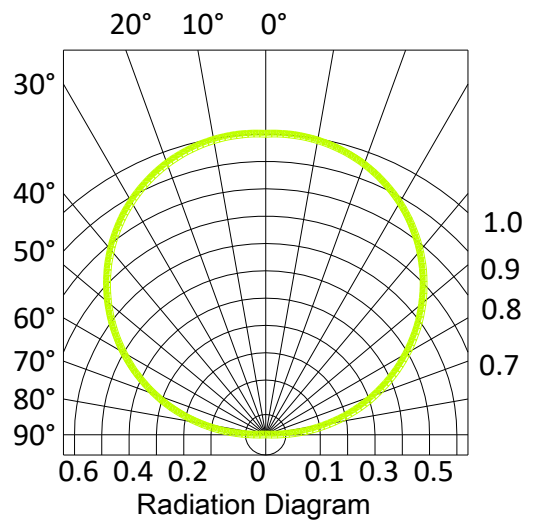
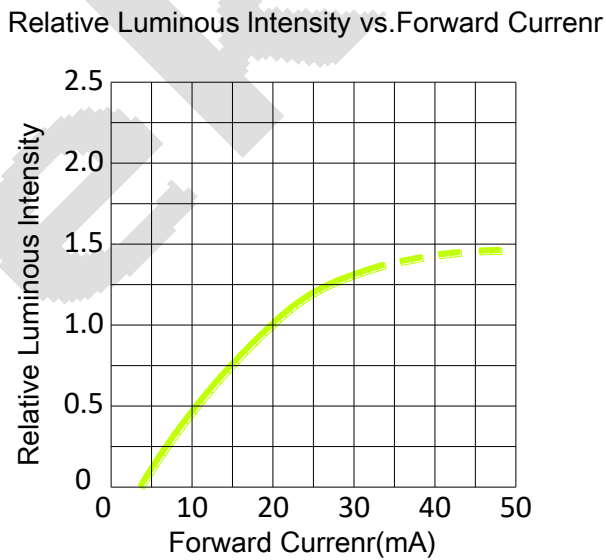
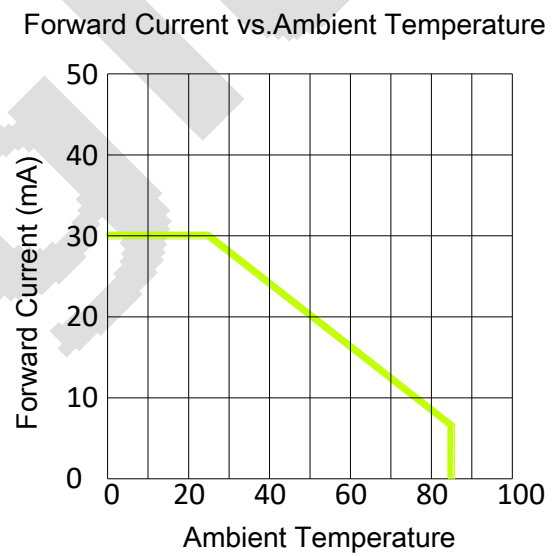
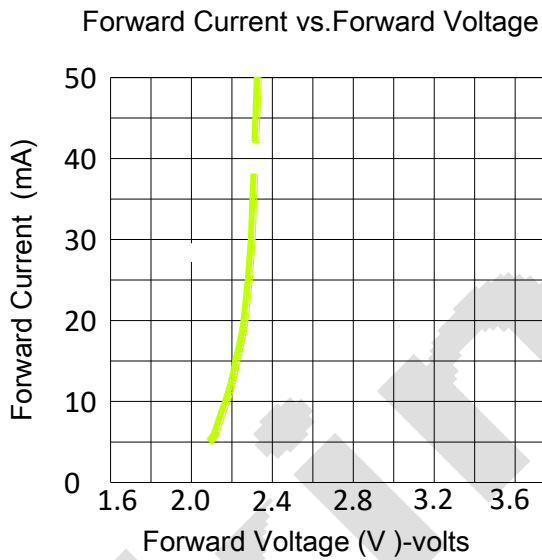
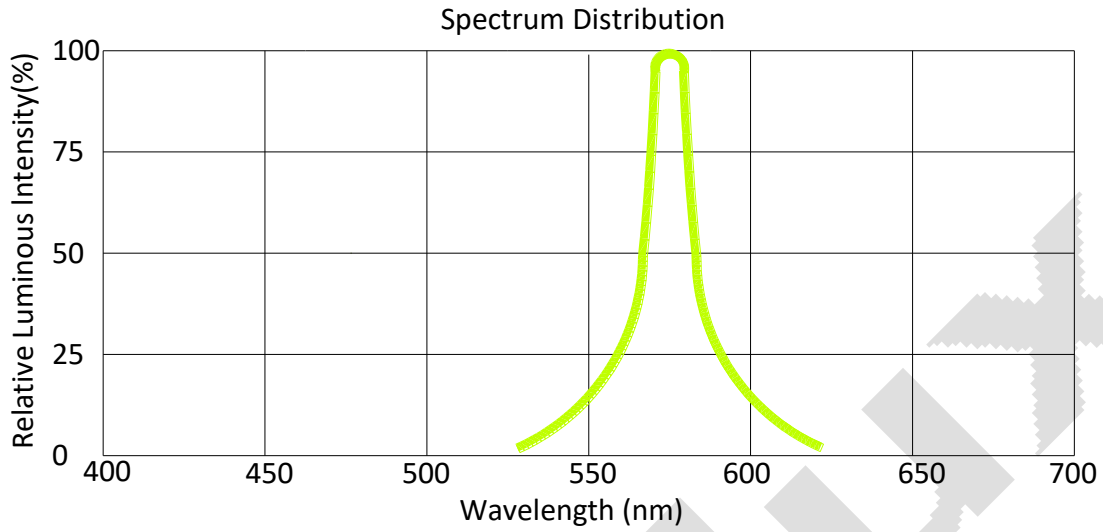



Bin Limits

Bin Range Of Luminous Intensity (Unit:mcd)

Bin Code	Min	Max	Condition
L1	30	50	IF=20mA
L2	50	70	
L3	-	-	

Bin Range Of Forward Voltage (Unit:V)

Bin Code	Min	Max	Condition
V1	1.9	2.0	IF=20mA
V2	2.0	2.1	
V3	2.1	2.2	
V4	2.2	2.3	
V5	2.3	2.4	

Bin Range Of Wavelength (Unit:nm)

Bin Code	Min	Max	Condition
YG1	567	569	IF=20mA
YG2	569	571	
YG3	571	573	
YG4	573	575	
YG5	-	-	

Notes:

- 1.Tolerance of Luminous Intensity ±10%
- 2.Tolerance of Forward Voltage ±0.1V

**Reliability Test Items And Conditions**

Test Items	Reference	Test Conditions	Time	Quantity	Criterion
Thermal Shock	MIL-STD-202G	-40°C (30min) -100°C (30min)	100 Cycles	22	0/22
Temperature And Humidity Cyclic	JEITA ED-4701 200 203	-10°C~65°C ; 0%~90%RH	10cycles	22	0/22
High Temperature Storage	JEITA ED -4071 200 201	Ta=100°C	1000H	22	0/22
Low Temperature Storage	JEITA ED -4071 200 202	Ta=-40°C	1000H	22	0/22
High Temperature High Humidity Storage	JEITA ED -4071 100 103	Ta=60°C ; RH=90%	1000H	22	0/22
High Temperature Life Test	JESD22-A108D	Ta=80°C	1000H	22	0/22
Life Test	JESD22-A108D	Ta=25°C IF=20mA	1000H	22	0/22
Resistance to Soldering Heat	GB/T 4937, II , 2.2&2.3	Tsol*=(240±5) °C 10secs	2 times	22	0/22

Criteria For Judging Damage

Test Items	Symbol	Test Conditions	Criteria For Judging Damage
Forward Voltage	V_F	$I_F=I_{FT}$	Initial Data±10%
Reverse Current	I_R	$V_R=5V$	$I_R \leq 10\mu A$
Luminous Intensity	I_V	$I_F=I_{FT}$	Average I_V degradation ≤30% ; Single LED I_V degradation ≤50%
Resistance to Soldering Heat	-	-	Material without internal cracks, no material between stripped, no dead light

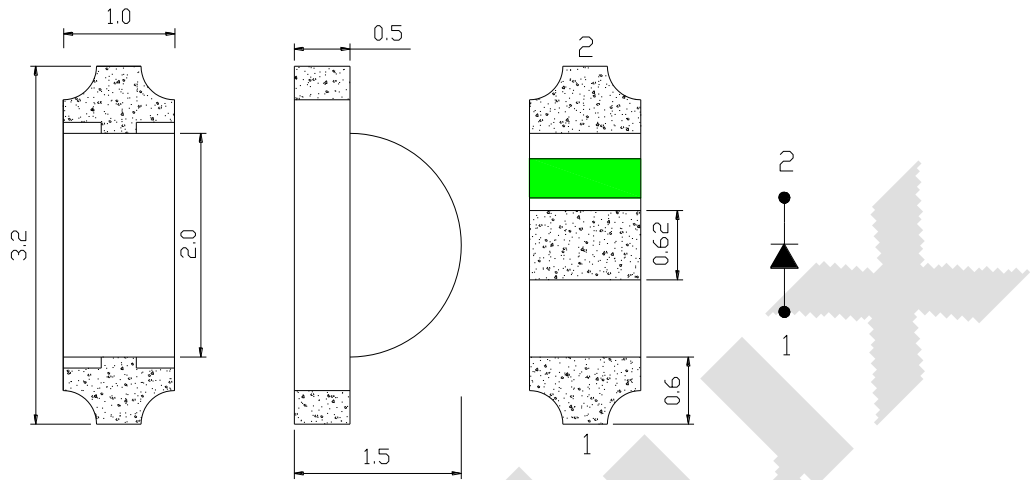
Product size (Unit:mm)

NOTES :

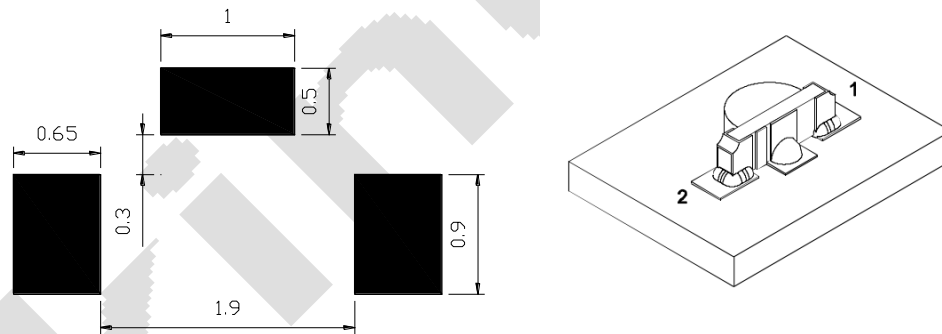
1. All dimensions are in millimeters (inches)
2. Tolerances are $\pm 0.2\text{mm}$ (0.008inch) unless otherwise noted

Recommended Soldering Pad Design (Unit:mm)

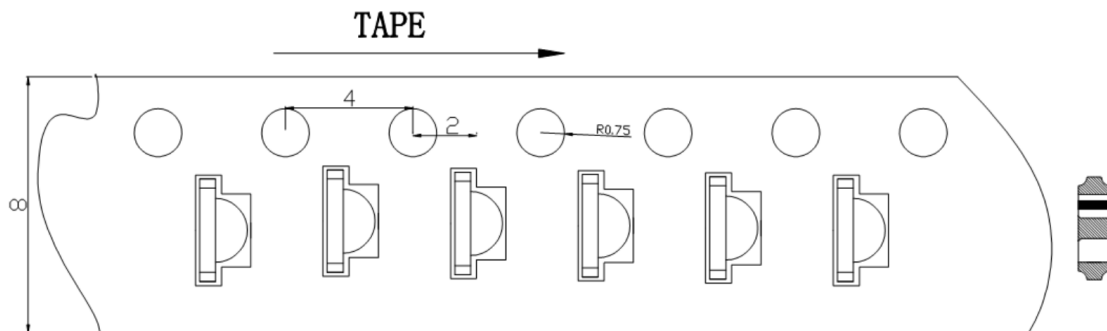
Taping and package Spec

- Tape Specification:3,000pcs Per Reel

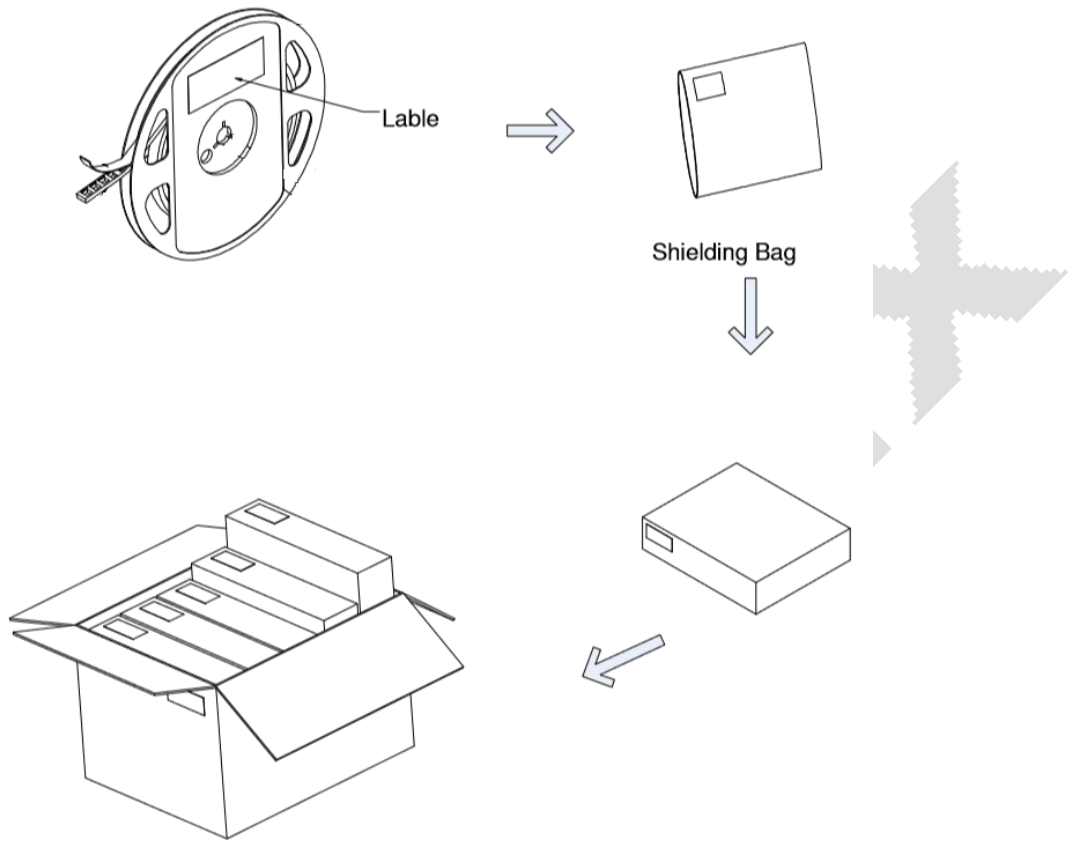

Packaging



LabelStyle

EKIINGLUX OPTOELECTRONICS(SHANGHAI) CO.,LTD



P/N:E6C1206QBAC1UDA

Emitting Color: Blue

HUE: 466-468 nm

IV :100-150 mcd



VF: 3.0-3.2 V *example* BIN Code: 2

QTY: 3000 PCS DATE: 2018/06/06



LOT NO.:1806103





Useful hint

Reflow Soldering Instructions

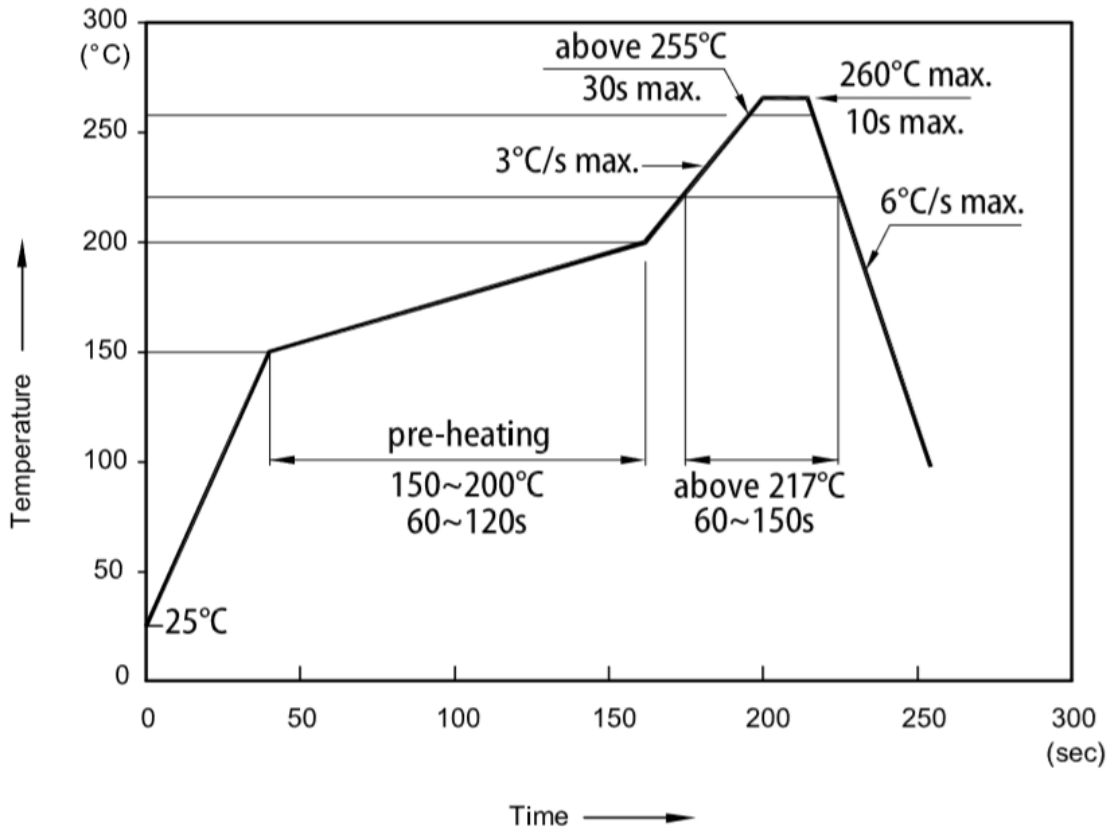

1. Don't cause stress to the LEDs while it is exposed to high temperature.
2. The maximum number of reflow soldering passes is 2 times.
3. Reflow soldering is recommended. Other soldering methods are not recommended as they might cause damage to the product.



Precautions

1. Storage:

- Moisture proof and anti-electrostatic package with moisture absorbent material is used, to keep moisture to a minimum.
- Before opening the package, the product should be kept at 30°C or less and humidity less than 60% RH, and be used within a year.
- After opening the package, the product should be stored at 30°C or less and humidity less than 10%RH, and be soldered within 24 hours (1day). It is recommended that the product be operated at the workshop condition of 30°C or less and humidity less than 60%RH.
- If the moisture absorbent material has faded away or the LEDs have exceeded the storage time, baking treatment should be performed based on the following condition: (70±5)°C for 24 hours.

2. Static Electricity:

Static electricity or surge voltage damages the LEDs. Damaged LEDs will show some unusual characteristics such as the forward voltage becoming lower, or the LEDs do not light at the low current, even not light.

All devices, equipment and machinery must be properly grounded. At the same time, it is recommended that wrist bands or anti-electrostatic gloves, anti-electrostatic containers be used when dealing with the LEDs.

3. Vulcanization:

LED curing is due to sulfur being in brackets and the +1 price of silver in the chemical reaction generated Ag₂S in the process. It will lead to the capacity of reflecting of silver layer reducing, light color temperature drift and serious decline, seriously affecting the performance of the product. So we should take corresponding measures to avoid vulcanization, such as to avoid using sulphur volatile substances and keeping away from high sulphur content of the material.