

20V N-Channel Enhancement Mode MOSFET

V_{DS} = 20V

R_{DS(ON)}, V_{GS}@4.5V, I_{DS}@5.0A < 28mΩ

R_{DS(ON)} V_{GS}@2.5V, I_{DS}@4.5A < 35mΩ

Features

Advanced trench process technology

High Density Cell Design For Ultra Low On-Resistance

Package Dimensions

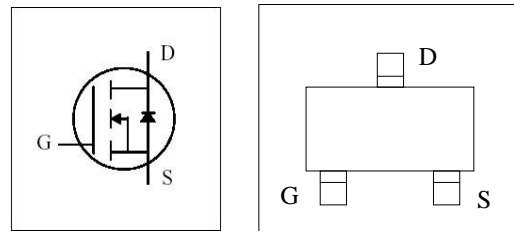
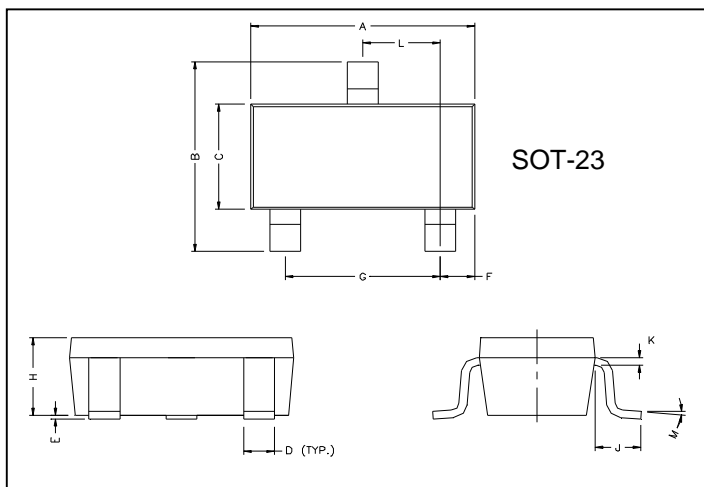

REF.	Millimeter		REF.	Millimete	
	Min.	Max.		Min.	Max.
A	2.80	3.00	G	1.80	2.00
B	2.30	2.50	H	0.90	1.1
C	1.20	1.40	K	0.10	0.20
D	0.30	0.50	J	0.35	0.70
E	0	0.10	L	0.92	0.98
F	0.45	0.55	M	0°	10°

Absolute Maximum Ratings (T_A=25°C unless otherwise noted)

Parameter	Symbol	Limit	Unit
Drain-Source Voltage	V _{DS}	20	V
Gate-Source Voltage	V _{GS}	±10	V
Drain Current-Continuous	I _D	5.0	A
Drain Current-Pulsed (Note 1)	I _{DM}	13.5	A
Maximum Power Dissipation	P _D	1.25	W
Operating Junction and Storage Temperature Range	T _J , T _{STG}	-55 To 150	°C
Thermal Resistance, Junction-to-Ambient (Note 2)	R _{θJA}	100	°C/W

Electrical Characteristics ($T_A=25^\circ\text{C}$ unless otherwise noted)

Parameter	Symbol	Condition	Min	Typ	Max	Unit
Off Characteristics						
Drain-Source Breakdown Voltage	BV_{DSS}	$V_{GS}=0V, I_D=250\mu A$	20	22	-	V
Zero Gate Voltage Drain Current	I_{DSS}	$V_{DS}=20V, V_{GS}=0V$	-	-	1	μA
Parameter	Symbol	Condition	Min	Typ	Max	Unit
Gate-Body Leakage Current	I_{GSS}	$V_{GS}=\pm 10V, V_{DS}=0V$	-	-	± 100	nA
On Characteristics (Note 3)						
Gate Threshold Voltage	$V_{GS(th)}$	$V_{DS}=V_{GS}, I_D=250\mu A$	0.4	0.65	0.8	V
Drain-Source On-State Resistance	$R_{DS(on)}$	$V_{GS}=2.5V, I_D=4.5 A$	-	27	35	m Ω
		$V_{GS}=4.5V, I_D=5A$	-	20	28	m Ω
Forward Transconductance	g_{FS}	$V_{DS}=15V, I_D=5A$	-	25	-	S
Dynamic Characteristics (Note4)						
Input Capacitance	C_{iss}	$V_{DS}=10V, V_{GS}=0V,$ $F=1.0MHz$	-	780	-	PF
Output Capacitance	C_{oss}		-	140	-	PF
Reverse Transfer Capacitance	C_{rss}		-	80	-	PF
Switching Characteristics (Note 4)						
Turn-on Delay Time	$t_{d(on)}$	$V_{DD}=10V, I_D=1A$ $V_{GS}=4.5V, R_{GEN}=6\Omega$	-	9	-	nS
Turn-on Rise Time	t_r		-	30	-	nS
Turn-Off Delay Time	$t_{d(off)}$		-	35	-	nS
Turn-Off Fall Time	t_f		-	10	-	nS
Total Gate Charge	Q_g	$V_{DS}=10V, I_D=5A, V_{GS}=4.5V$	-	11.4	-	nC
Gate-Source Charge	Q_{gs}		-	2.3	-	nC
Gate-Drain Charge	Q_{gd}		-	2.9	-	nC
Drain-Source Diode Characteristics						
Diode Forward Voltage (Note 3)	V_{SD}	$V_{GS}=0V, I_S=2A$	-	-	1.2	V
Diode Forward Current (Note 2)	I_S		-	-	5	A

Notes:

- 1 Repetitive Rating: Pulse width limited by maximum junction temperature.
2. Surface Mounted on FR4 Board, $t \leq 10$ sec.
3. Pulse Test: Pulse Width $\leq 300\mu s$, Duty Cycle $\leq 2\%$.
4. Guaranteed by design, not subject to production

Typical Electrical and Thermal Characteristics

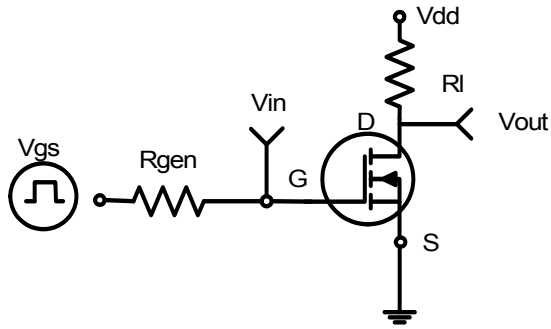

Figure 1: Switching Test Circuit

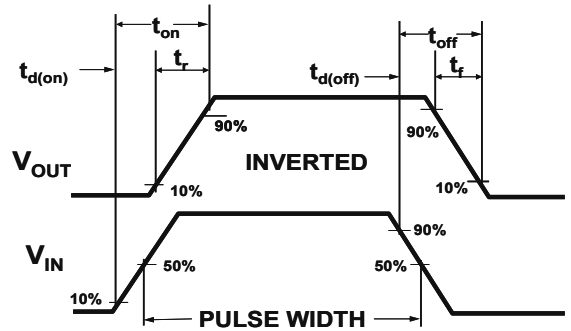

Figure 2: Switching Waveforms

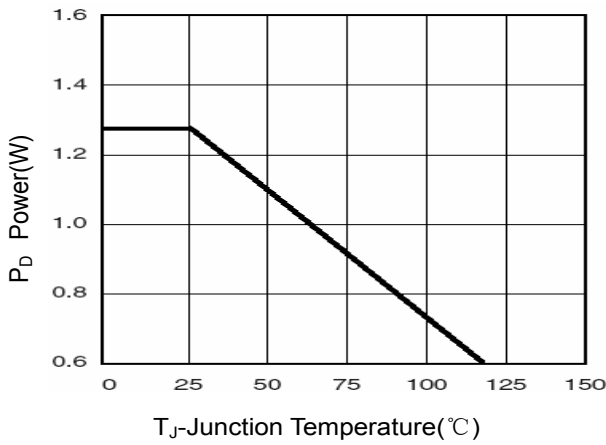

Figure 3 Power Dissipation

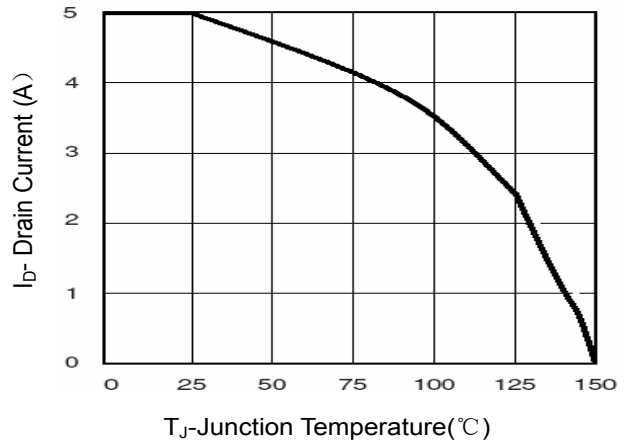

Figure 4 Drain Current

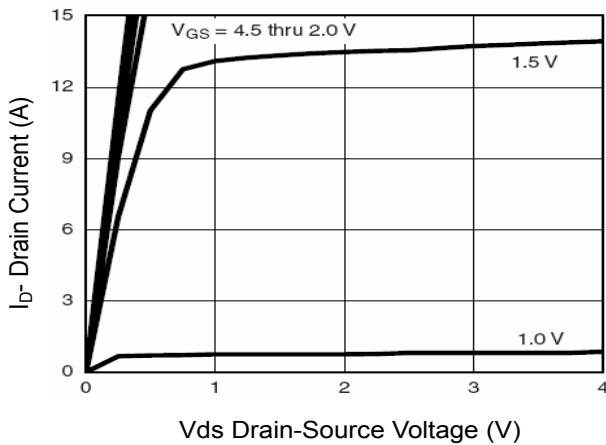

Figure 5 Output Characteristics

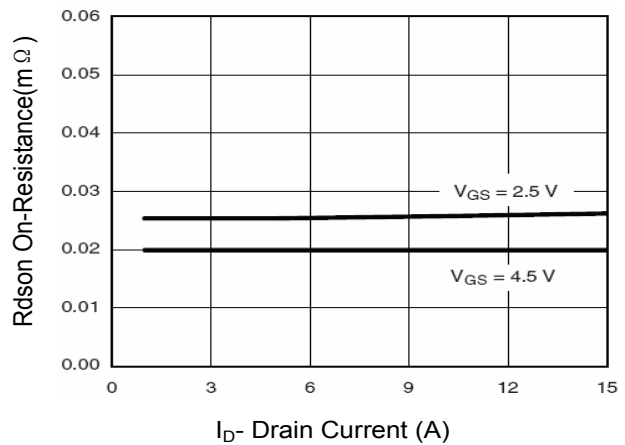

Figure 6 Drain-Source On-Resistance

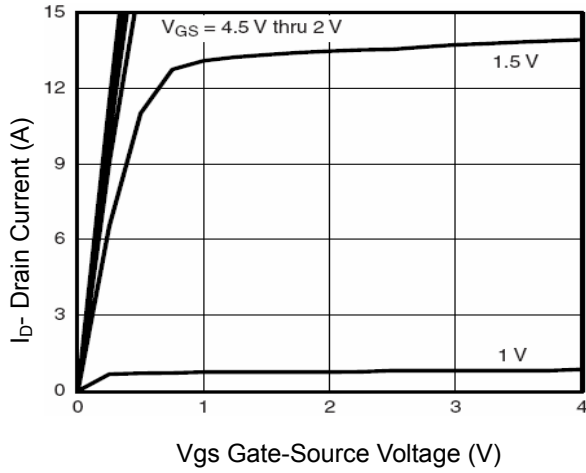

Figure 7 Transfer Characteristics

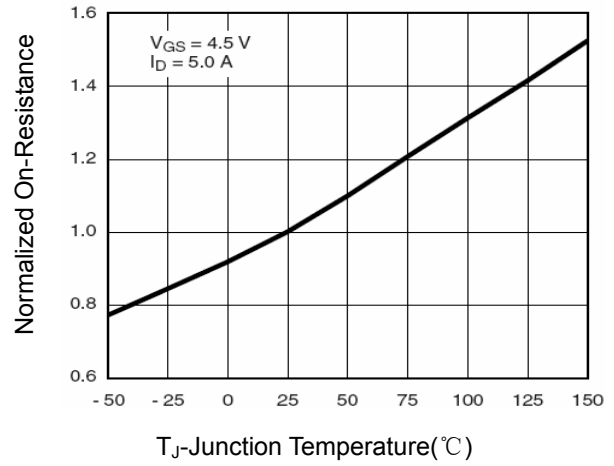

Figure 8 Drain-Source On-Resistance

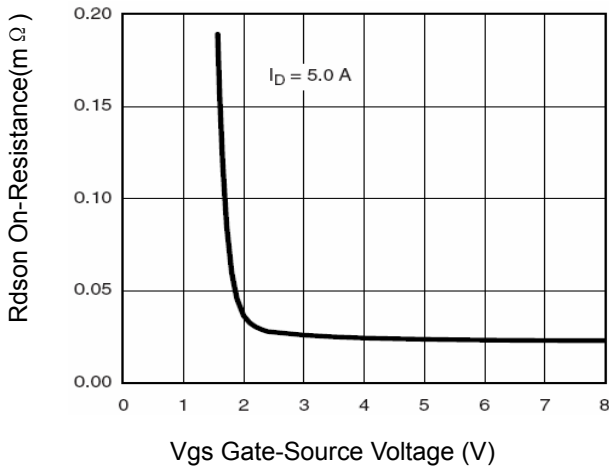

Figure 9 Rdson vs Vgs

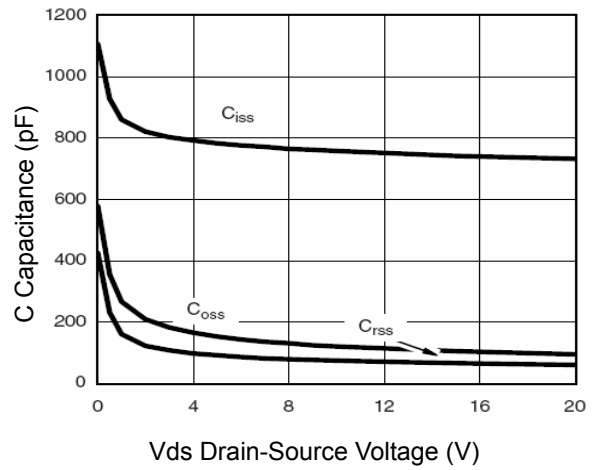

Figure 10 Capacitance vs Vds

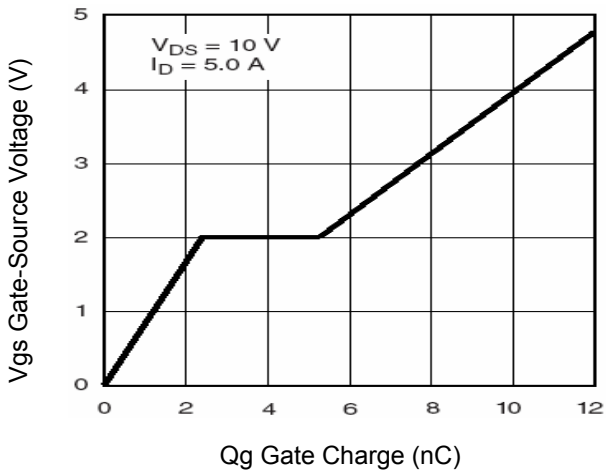

Figure 11 Gate Charge

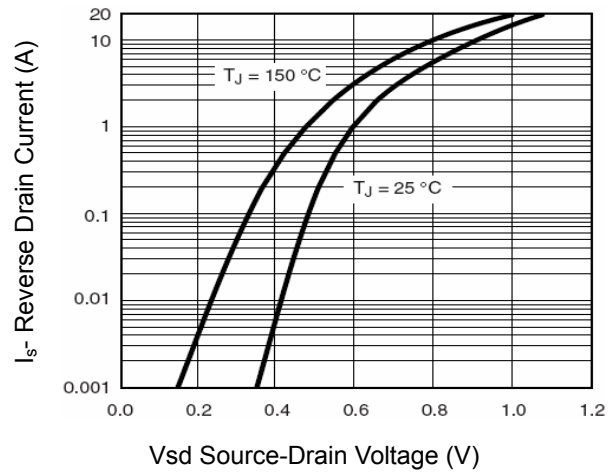

Figure 12 Source-Drain Diode Forward

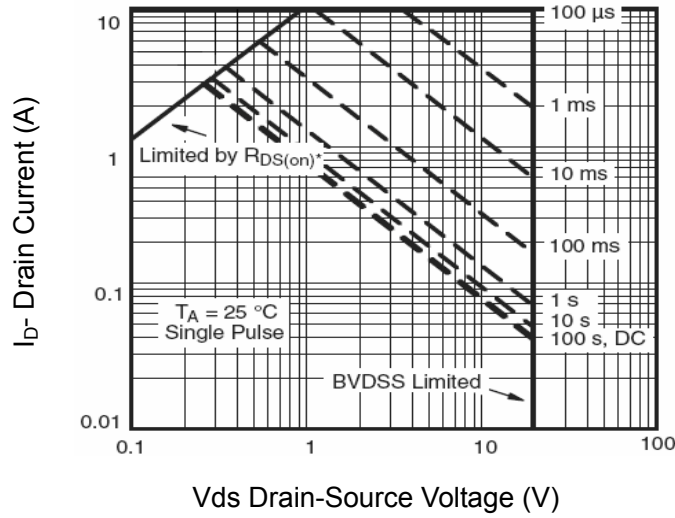

Figure 13 Safe Operation Area

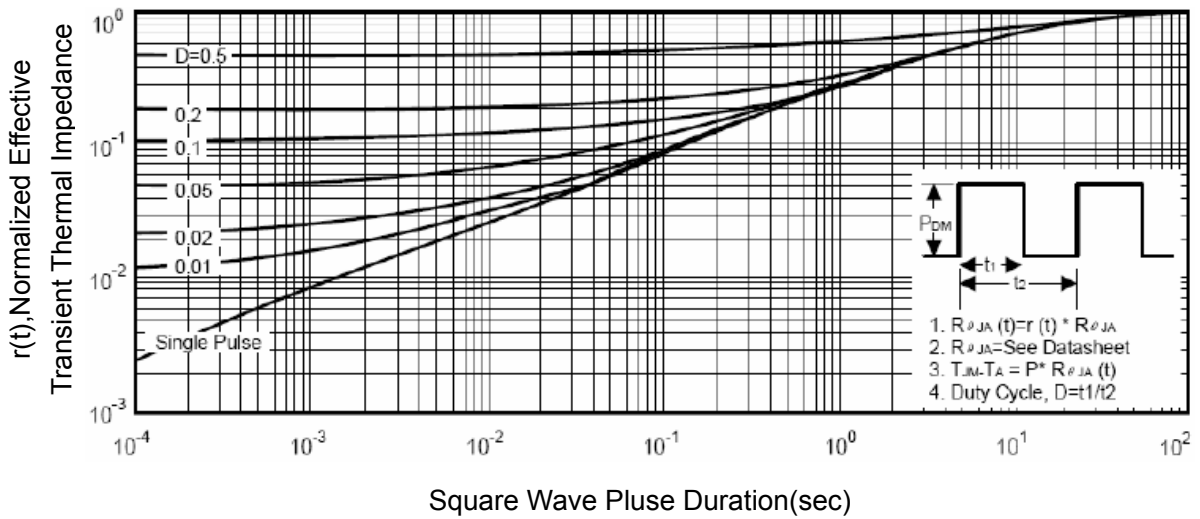

Figure 14 Normalized Maximum Transient Thermal Impedance